

90°

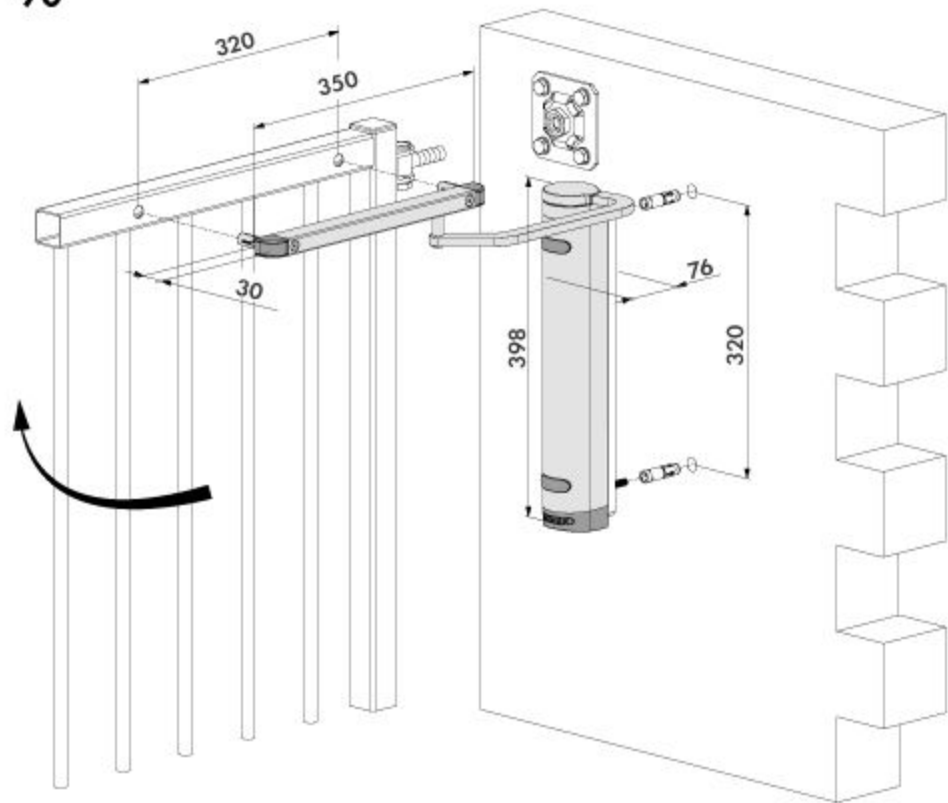

180°

