

ÉDITION
2020



grande forge

FRANCE
gf
1948

LAITON

PARIS



PAGES
6>11

DIAMOND



PAGES
12>17

MODERN



PAGES
18>23

SQUARE



PAGES
24>29

VERSAILLES



PAGES
30>37

ROYAL



PAGES
38>43

COMTESSE



PAGES
44>47

CLASSIC



PAGES
48>51

HARMONIE



PAGES
52>55

MAIN-COURANTE
ACCESSOIRES



PAGES
56>63

TÊTE DE DÉPART
CACHE SCCELLEMENT



PAGES
64>67

NEW-YORK



PAGES
68>73

SKYPORT



PAGES
78>89

CARBONE

CARBONE

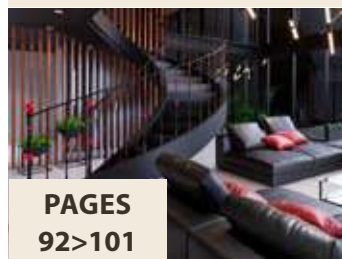

PAGES
92>101

POTELET A CORDE



PAGES
102>103

FONTE ART



PAGES
106>111

MANCHONS



PAGES
112

PALMETTES



PAGES
113>115

INOX

FONTE

ALUMINIUM

POTEAU/BARREAU
PALMETTES

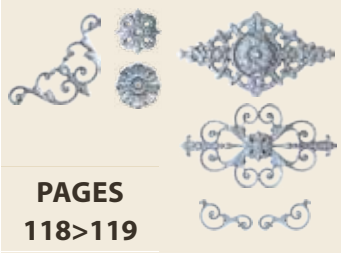

PAGES
118>119

FER

BLACK DIAMOND



PAGES
122>127

PRESTIGE



PAGES
128>133

RONDE



PAGES
134>141

MOZART



PAGES
142>147

CITY



PAGES
148>151

QUARTZ

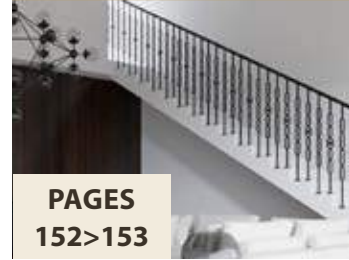

PAGES
152>153

TRADITION



PAGES
154>165

RUSTIQUE



PAGES
166>169

CASTEL

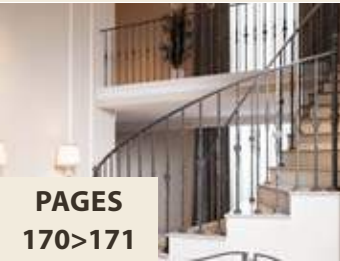

PAGES
170>171

MASTERS



PAGES
172>173

VENEZIA



PAGES
174

MAIN COURANTE

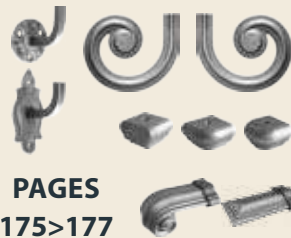

PAGES
175>177

TRAVERSE
BARRE DE FER



PAGES
178>181

ÉLÉMENT DÉCO



PAGES
182>184

VOLUTES



PAGES
185>187

HAUT DE PORTAIL

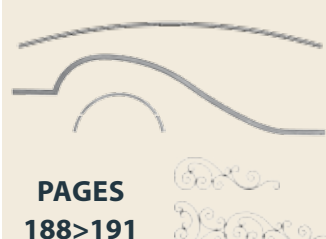

PAGES
188>191

MANCHON



PAGES
192>193

SPHÈRE
COLLIERS



PAGES
194>195

CACHES
SCELLEMENTS



PAGES
196>197

FEUILLES



PAGES
198>199

PALMETTES



PAGES
200>201

POINTE DE LANCE
ORNEMENTS



PAGES
202>207

SERRURES



PAGES
208>210

PEINTURES

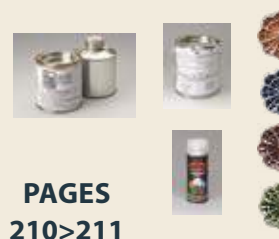

PAGES
210>211

GOND/FIXATION



PAGES
212>218

SYSTÈME
COULISSANT



PAGES
219>231

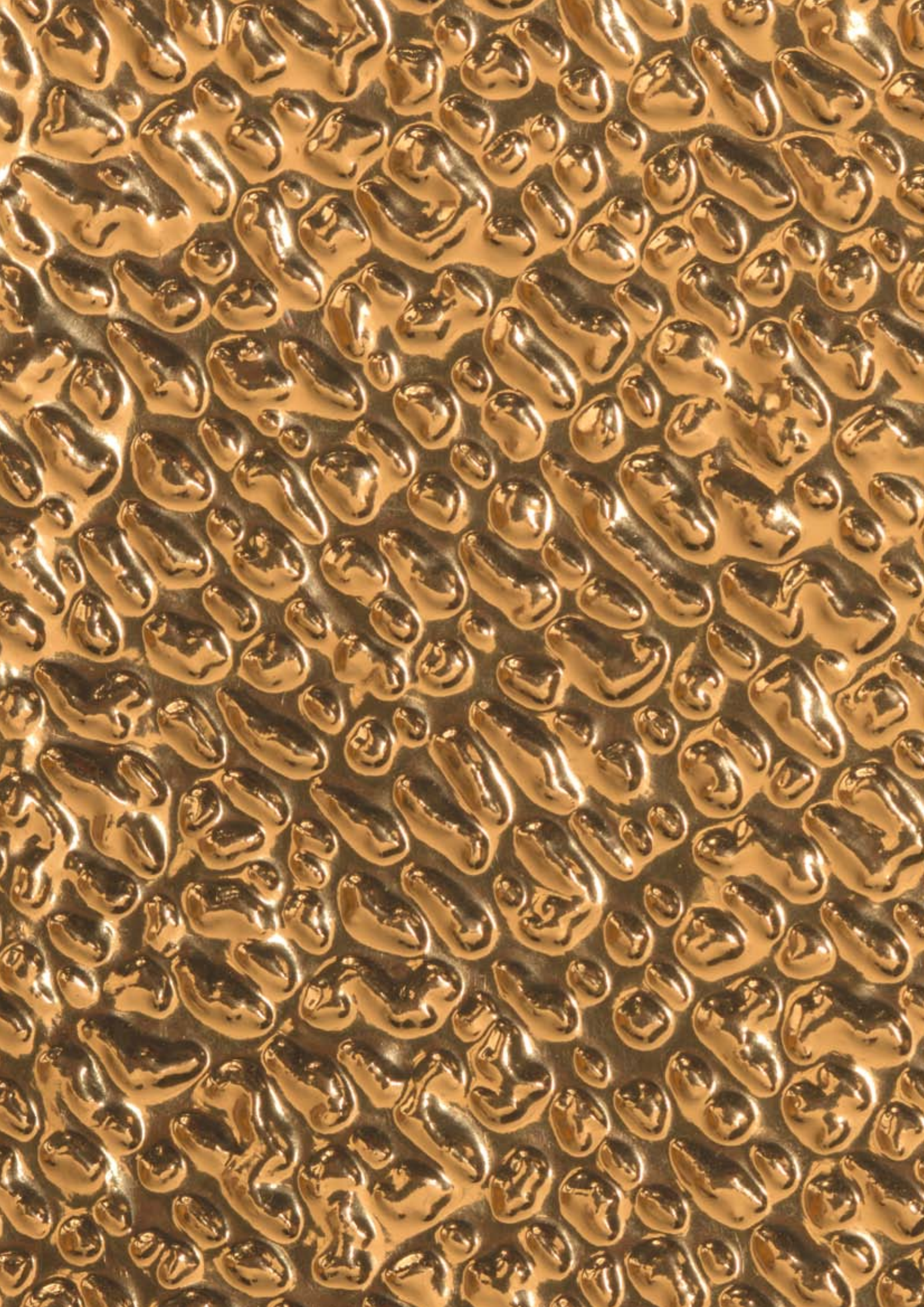

LAITON

PARIS

FRANÇAIS : PARIS, ville des lumières, symbole de culture et d'élégance est le nom donné à ces magnifiques balustres. En laiton nickelé et doré à l'or fin 24 carats, ils sont montés au choix avec des embouts "guillochés" en laiton nickelé ou bien avec des embouts lisses en acier, soudables. Suprême raffinement : au centre, un cristal taillé Swarovski®. Balustres et poteaux conçus exclusivement pour l'intérieur.

DEUTSCH : PARIS, Lichterstadt, Sinnbild von Kultur und Eleganz. Wunderschöne Zierstäbe der Serie PARIS aus vernickeltem und 24 Karat vergoldetem Messing. Sie sind zu Ihrer Auswahl mit guillochierten und vernickelten Messingendstücken oder mit glatten Eisenendstücken zum verschweißen. Höchste Vollendung : In der Mitte ein Kristall von Swarovski®. Verwendung ausschließlich für den Innenbereich.

ENGLISH : PARIS, the city of lights, the symbol of culture and elegance is the name given to these splendid balusters. Made of nickel-plated and 24 carat gilded brass, they are supplied with "guilloched" nickel-plated brass ends or with smooth steel ends, fully weldable. Please specify. Supreme refinement : In the centre a lead crystal cut by Swarovski®. Balusters and posts are for indoor use only.

NEDERLANDS: PARIJS, de stad van het licht, het symbool van cultuur en elegantie. Dit is de naam die gegeven is aan de prachtige sierspijken. Gemaakt van vernikkeld en 24 karaat verguld messing. U kunt kiezen met guilloched (bewerkte) en vernikkelde messing of met gladde stalen uiteinden, volledig lasbaar. Suprême verfijning: In het midden een kristal van Swarovski®. Gebruik: uitsluitend voor interieurs.

ESPAÑOL: PARIS ciudad de la luz, símbolo de la cultura y de la elegancia, es el nombre dado a estos magníficos balaustres. De latón niquelado y dorado con oro fino de 24 quilates, están montados con remates en los extremos a elegir entre: latón niquelado grabados con un entrecruzado de líneas o bien en acero que se pueden soldar. Elegancia suprema: en el centro, un cristal tallado por Swarovski®. Balaustres y arranques concebidos exclusivamente para el interior.

RUSSE: Париж, город огней, символ современной культуры и элегантности, дал название этим искрящимся стойкам. Изготовленные из никелированной или золочёной (24 карата) латуни, они могут поставляться с «гильошированными» никелированными наконечниками или стальными наконечниками, подготовленными под сварку. В центре располагается вставка из свинцового хрусталя, огранённая фирмой STRASS® SWAROVSKI® CRYSTAL. Стойки и основания предназначены для установки только внутри помещений.



DORÉ



G = BL530G

NICKELÉ



NI = BL530NI

CHROME NOIR



CN = BL530CN

SATIN



SA = BL530SA

OR ROSE



RG = BL530RG



PL 530



PL 530 **CN**



PL 530 **NI**



PL 530 **SA**

PARIS



| | | | | | | |
|--------------------------------------|--------|------------------------------|--------|--------|--------|--|
| Embouts guilochés Guilloched ends | PL 530 | гильошированные окончания | BL 531 | PL 540 | BL 541 | Terminaciones grabadas Guillocherte Enden |
| Embouts en fer Mild iron ends | PL 550 | стальные окончания | BL 551 | PL 560 | BL 561 | Terminaciones en hierro Stahl Endstücke |



M10

TBL 30



M10

TBL 40

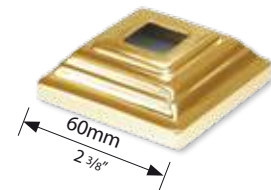

16 mm
5/8"

CSL 616

Embouts en fer
Mild iron ends
Terminaciones en hierro
Stahl Endstücke
стальные окончания

Embouts guilochés
Guilloched ends
Terminaciones grabadas
Guillochierte Enden
гильшированные
окончания

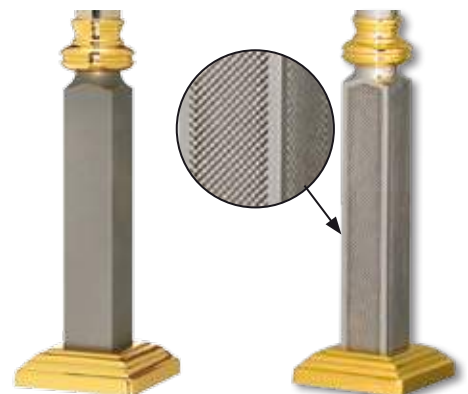

| | | | | |
|--------------------------------------|--------|--------|--------|---|
| Embouts guilochés Guilloched ends | PL 510 | BL 511 | BL 512 | Terminaciones grabadas Guillochierte Enden |
| Embouts en fer Mild iron ends | PL 500 | BL 501 | BL 502 | Terminaciones en hierro Stahl Endstücke |

PARIS NICKEL

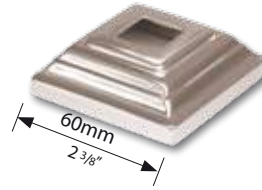
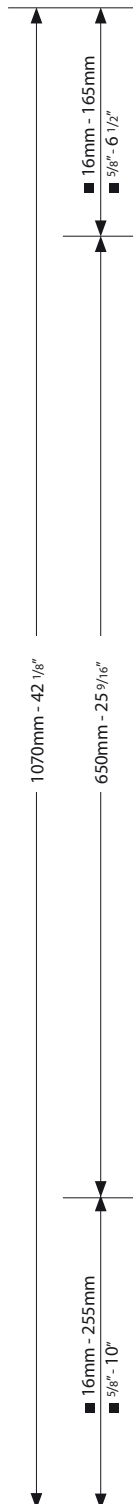
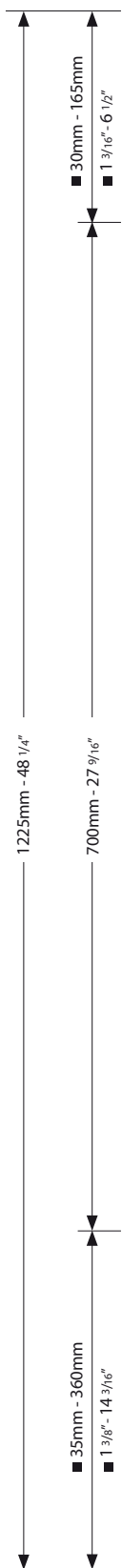

16 mm 5/8" CSL 616 NI

ø 95mm
H : 135mm

ø 3 3/4"
H : 5 1/4"



M10

TIGER EYE

TBL 53-TE-NI

| | | | | | | |
|---------------------------------------|-------------|---------|-------------|---------|---------|--|
| Embouts guillochés Guilloched ends | PL530-TE-NI | PL510NI | BL531-TE-NI | BL511NI | BL512NI | гильшированные окончания стальные окончания |
| Embouts en fer Mild iron ends | PL550-TE-NI | PL500NI | BL551-TE-NI | BL501NI | BL502NI | |

TABLEAU DES DECLINAISONS
TABLE OF DECLINATIONS
DEKLINATIONSTABELLE
TABEL MED AFVISNINGER
TABLA DE DECLINACIONES
ТАБЛИЦА СКЛОНЕНИЙ

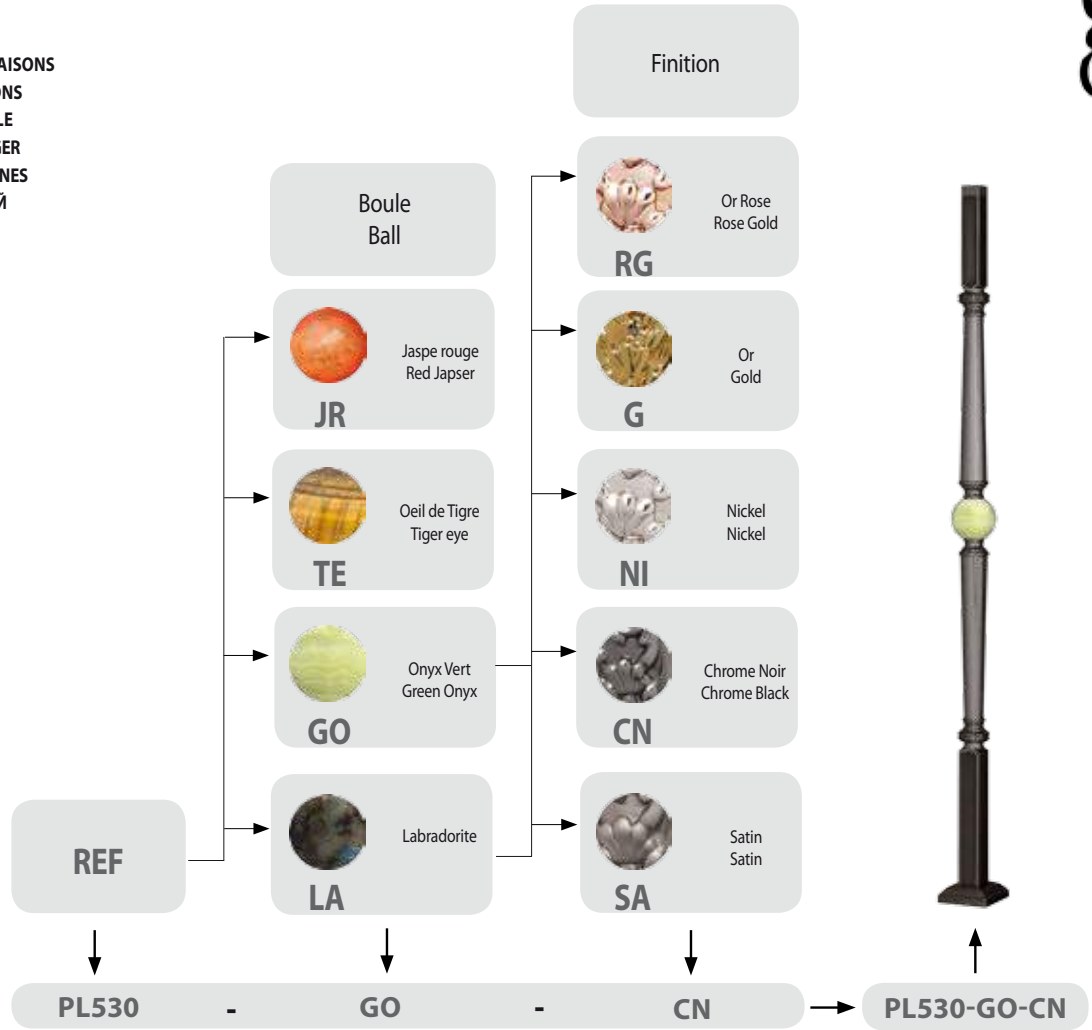

Exemple de combinaison
Combination example
Kombinationsbeispiel
Combinatie voorbeeld
Ejemplo de combinación
Пример комбинации



| | | | | | |
|---------------------------------------|-------------|-------------|-------------|-------------|-------------|
| Embouts guillochés Guilloched ends | PL530-GO-NI | PL530-JR-NI | PL530-GO-CN | PL530-LA-CN | PL530-JR-RG |
| Embouts en fer Mild iron ends | PL550-GO-NI | PL550-JR-NI | PL550-GO-CN | PL550-LA-CN | PL550-JR-RG |

DIAMOND

FRANÇAIS : De véritables bijoux que ces cristaux étincelants taillés par Swarovski. L'éclat de l'or rehausse leur splendeur. Ils sont sertis dans des balustres résolument contemporains, mais élégants et de grande classe. Ils sont assemblés, au choix, avec des embouts en acier ROND (R) OU CARRÉ (K).

DISPONIBLE AVEC EMBOUTS GUILLOCHÉS SUR DEMANDE. Usage exclusif en intérieur.

DEUTSCH : Wahre Juwelen, diese glitzernden Kristalle geschliffen von Swarovski. Sie sind in durchaus zeitgenössischen Zierstäben gefasst. Die Endstücke, RUND (R) ODER VIERKANT (K), aus Stahl ermöglichen jede Art der Bearbeitung.

LIEFERBAR MIT GUILLOCHIERTE ENDEN AUF ANFRAGE. Verwendung ausschließlich für den Innenbereich.

ENGLISH : Genuine heirlooms that these flashing crystals cut by Swarovski. The gleaming gold enhances their splendour. They are set in resolutely contemporary banisters, but elegant looking and of upper class. They are mounted with ROUND (R) OR SQUARE (K) steel endpieces, weldable.

AVAILABLE WITH GUILLOCHED ENDS UPON REQUEST. For indoor use only.

NEDERLANDS : Een juweel voor het oog, deze schitterend geslepen Swarovski. Deze zijn toegepast op hedendaagse sierspijken. De RONDE (R) OF VIERKANTE (K) eindstukken zijn van staal en kunnen op allerlei manieren worden bewerkt.

LEVERBAAR IN GEPATINEERDE UITVOERING OP AANVRAAG. Gebruik: uitsluitend voor interieurs.

ESPAÑOL: Verdaderas joyas son estos centelleantes cristales tallados por Swarovski. El baño de oro realza su esplendor. Están insertados en balaustras resueltamente contemporáneos pero elegantes y de gran categoría.

Están ensamblados con terminaciones de acero REDONDO (R) Ó CUADRADO (K) a elegir.

DISPONIBLE CON TERMINACIONES GRABADAS BAJO PEDIDO. Uso exclusivo para interior.

RUSSE : Этот сверкающий хрусталь, огранён фирмой Swarovski. Мерцающее золото придаёт ему великолепие.

Прекрасно смотрятся как в современных, так и в

классических интерьерах. **Возможна комплектация с «гильошированными» окончаниями под заказ.**

Предназначены для установки только внутри помещений.



DORÉ



G = BL244G

NICKELÉ



NI = BL244NI

CHROME NOIR



CN = BL244CN

SATIN



SA = BL244SA

OR ROSE



RG = BL244RG



BL 244



BL 244 **CN**



BL 244 **NI**



BL 244 **SA**

DIAMOND



| | | | | |
|----------------|-----------------|-----------------|-----------------|-----------------|
| ● 16mm 5/8" | BL 246 R | BL 243 R | BL 244 R | BL 245 R |
| ■ 16mm 5/8" | BL 246 K | BL 243 K | BL 244 K | BL 245 K |



M10

TBL 30

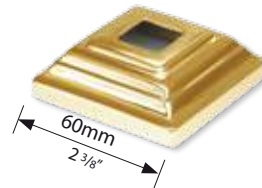

■ 16 mm
5/8" CSL 616

DISPONIBLE AVEC EMBOUTS GUILLOCHÉS SUR DEMANDE.

LIEFERBAR MIT GUILLOCHIERTE ENDEN AUF ANFRAGE.

AVAILABLE WITH GUILLOCHED ENDS UPON REQUEST.

LEVERBAAR IN GEPATINEERDE UITVOERING OP AANVRAAG.

DISPONIBLE CON TERMINACIONES GRABADAS BAJO PEDIDO.

ВОЗМОЖНА КОМПЛЕКТАЦИЯ С «ГИЛЬОШИРОВАННЫМИ» ОКОНЧАНИЯМИ ПОД ЗАКАЗ.

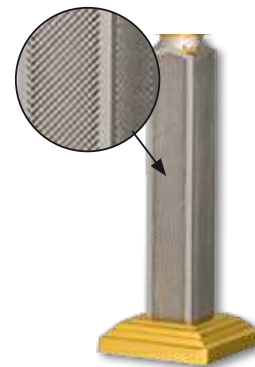

FRANÇAIS : Balustre dans son emballage plastique, qui doit rester en place jusqu'à la fin des travaux.

DEUTSCH : Zierstab in Plastikfolie verpackt, die erst nach Beendigung der Montage entfernt wird.

ENGLISH : Baluster in its plastic wrapper which should be kept on until installation has been completed.

NEDERLANDS : Sierspijlen zijn in plastic folie verpakt, die pas na montage verwijderd mag worden.

ESPAÑOL : Balaustre en su envoltorio de plástico, que debe permanecer en su sitio hasta la total terminación de los trabajos.

RUSSE : Стойки поставляются в пластиковой упаковке, которую не следует снимать до окончания монтажа.

● PL 242 R
■ PL 242 K

● PL 240 R
■ PL 240 K

DIAMOND CHROME NOIR

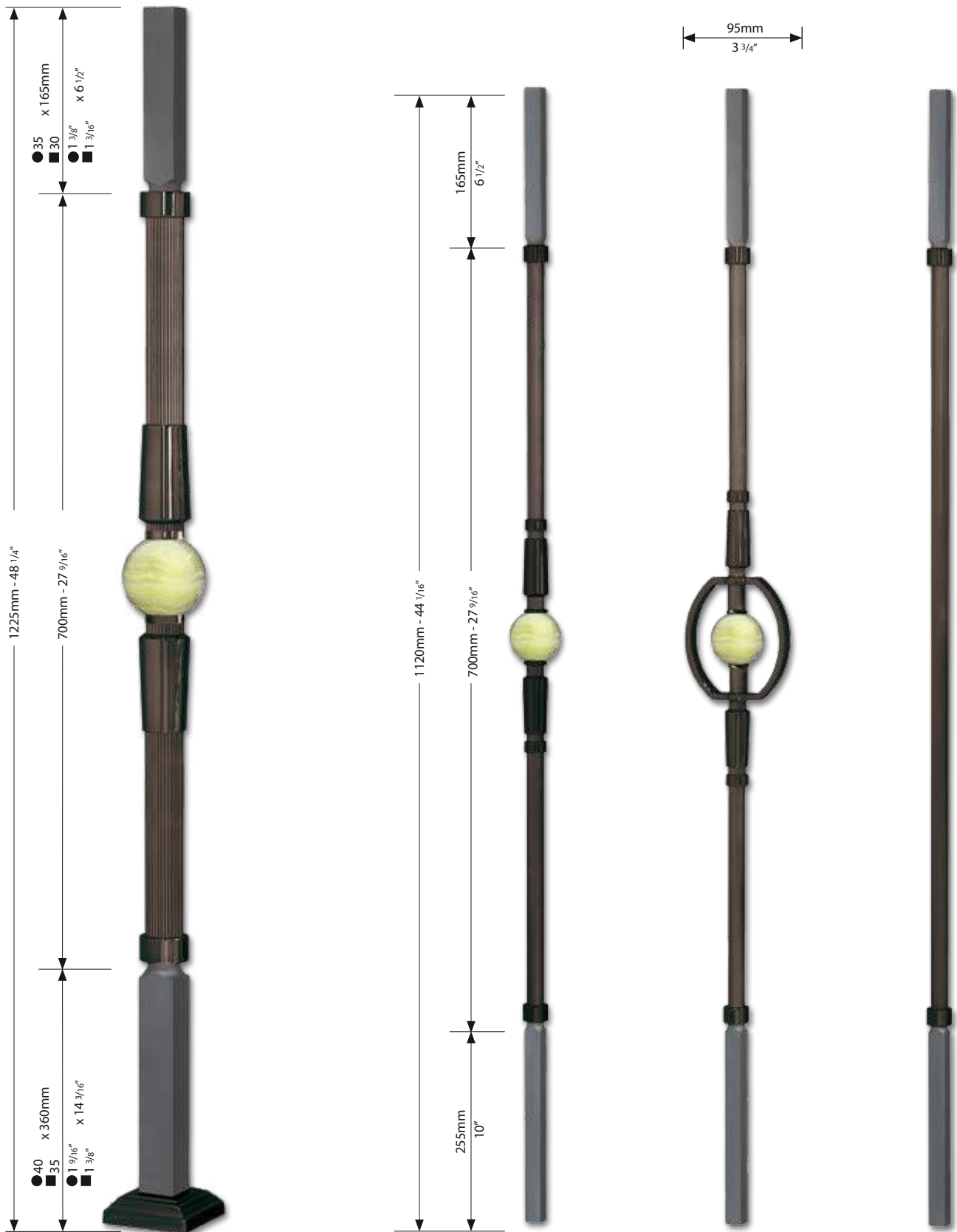

- PL 240 R-GO-CN
- PL 240 K-GO-CN

- | | | | |
|----------------|----------------|----------------|------------|
| ● 16mm 5/8" | BL 246 R-GO-CN | BL 243 R-GO-CN | BL 245 RCN |
| ■ 16mm 5/8" | BL 246 K-GO-CN | BL 243 K-GO-CN | BL 245 KCN |



TBL 53-GO-CN

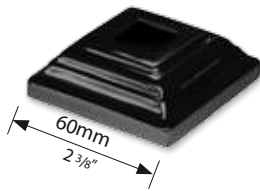

■ 16 mm
5/8" **CSL 616CN**



● 16 mm
5/8" **CSL61 CN**

Exemple de combinaison
Combination example
Kombinationsbeispiel
Combinatie voorbeeld
Ejemplo de combinación
Пример комбинации



- **PL240R-TE-G**
- **PL240R-LA-NI**
- **PL240R-JR-RG**
- **PL240K-TE-G**
- **PL240K-LA-NI**
- **PL240K-JR-RG**

TABLEAU DES DECLINAISONS
TABLE OF DECLINATIONS
DEKLINATIONSTABELLE
TABEL MED AFVISINGER
TABLA DE DECLINACIONES
ТАБЛИЦА СКЛОНЕНИЙ

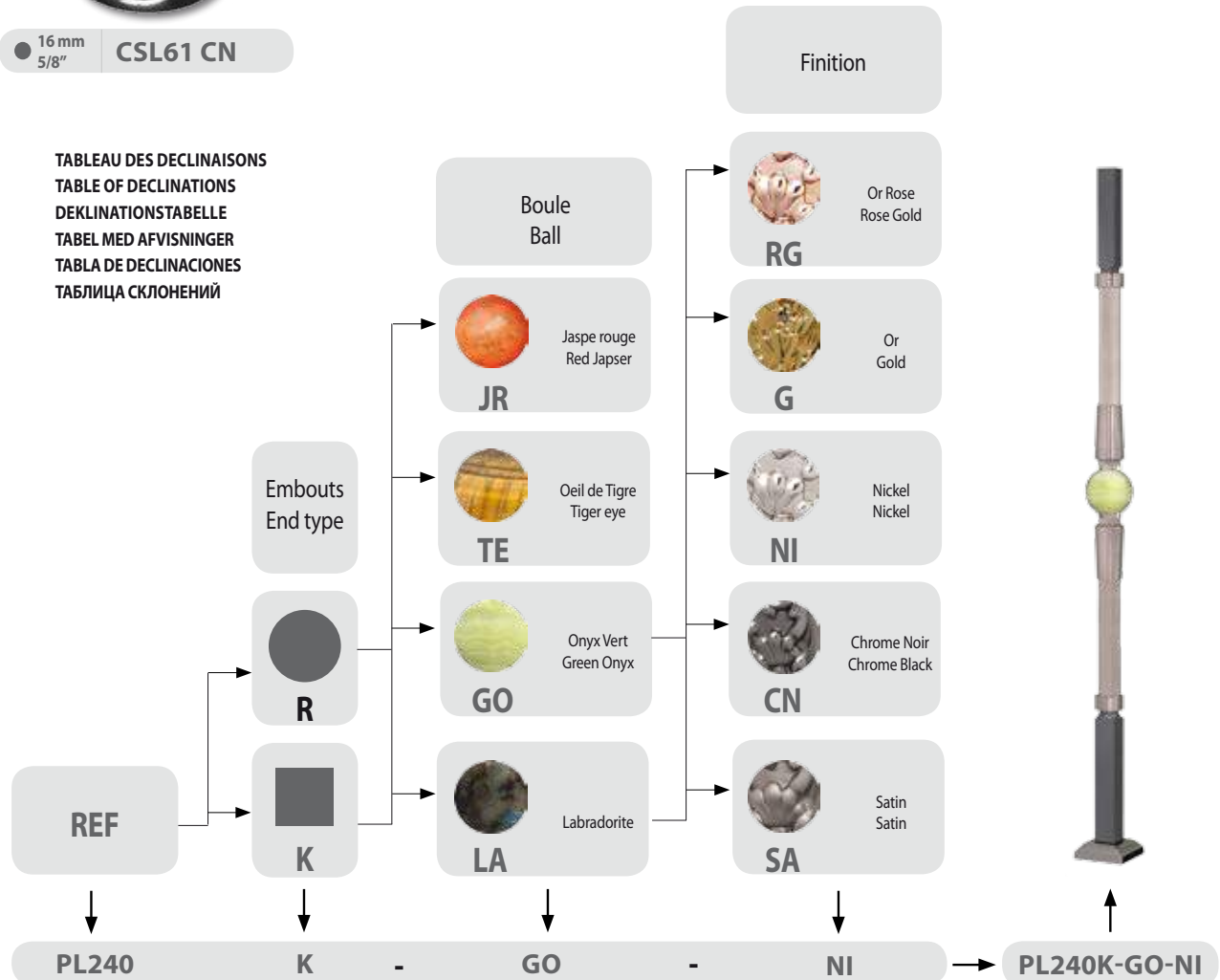

MODERN

FRANÇAIS : Le corps de ces balustres et poteaux est en acier inoxydable finition satinée et en laiton poli et verni. Ils sont montés, au choix, avec des embouts en acier **CARRÉS (K) ou RONDS (R)**, permettant éventuellement le montage de la rampe par soudage. Usage exclusif en intérieur.

DEUTSCH : Die Mittelteile dieser Zierstäbe und Pfosten sind hergestellt aus Edelstahl satiniert, und Messing poliert und lackiert. Die Endstücke aus **VIERKANT (K) oder RUND (R)** Stahl ermöglichen jede Art der Bearbeitung, z.B. Schweißen. Verwendung ausschließlich für den Innenbereich.

ENGLISH : The bodies of these balusters and posts are made of stainless steel satin finish and polished and lacquered solid brass. They are mounted with **ROUND (R) or SQUARE (K)** steel endpieces, allowing for the assembly of the railing by welding. For indoor use only.

NEDERLANDS : De middenstukken van deze sierspijlen en balusters bestaan uit roestvrij staal en messing, gepolijst en gelakt. De **RONDE of VIERKANTE** eindstukken zijn van staal en kunnen op allerlei manieren worden bewerkt. Gebruik: uitsluitend voor interieurs.

ESPAÑOL : El cuerpo de estos balaustres y arranques es de acero inoxidable y latón pulido y barnizado. Las terminaciones de acero son **REDONDAS o CUADRADAS** a elegir. Uso exclusivo para interior.

RUSSE : Эти стойки и столбы изготовлены из нержавеющей стали с сатинированной обработкой и из цельных полированных и покрытых лаком латунных элементов. Стойки крепятся стальными **КРУГЛЫМИ (R) или КВАДРАТНЫМИ (K)** наконечниками, которые можно приваривать к перилам. Предназначены для установки только внутри помещений.

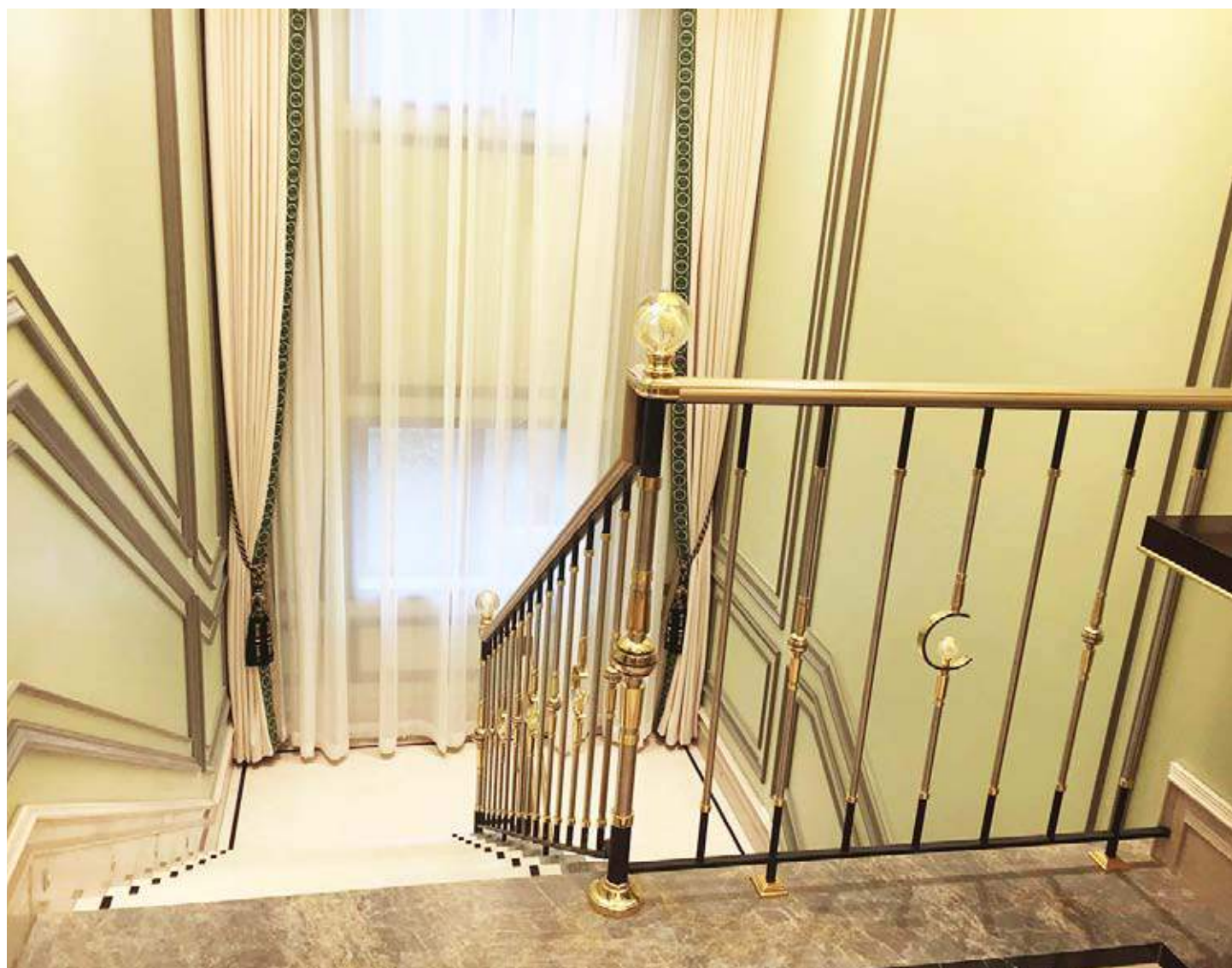

MODERN FINITION

DORÉ



G = BL178G

NICKELÉ



NI = BL178NI

CHROME NOIR



CN = BL178CN

SATIN



SA = BL178SA

OR ROSE



RG = BL178RG



BL 178



BL 178-LA-CN



BL 178-LA-NI



BL 178-LA-SA

MODERN



● PL 170 R
■ PL 170 K

| | | | | |
|----------------|----------|----------|----------|----------|
| ● 16mm 5/8" | BL 177 R | BL 178 R | BL 175 R | BL 179 R |
| ■ 16mm 5/8" | BL 177 K | BL 178 K | BL 175 K | BL 179 K |



FRANÇAIS : Balustre dans son emballage plastique, qui doit rester en place jusqu'à la fin des travaux.

DEUTSCH : Zierstab in Plastikfolie verpackt, die erst nach Beendigung der Montage entfernt wird.

ENGLISH : Baluster in its plastic wrapper which should be kept on until installation has been completed.

NEERLANDS : Sierspijlen zijn in plastic folie verpakt, die pas na montage verwijderd mag worden.

ESPAÑOL : Balaustre en su envoltorio de plástico, que debe permanecer en su sitio hasta la otal terminación de los trabajos.

RUSSE : Стойки поставляются в пластиковой упаковке, которую не следует снимать до окончания монтажа.

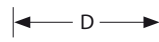

D

| | | |
|----------|---------|--------|
| ● 10 mm | 53 mm | CSL 50 |
| ● 3/8" | 2 1/16" | |
| ● 14 mm | 53 mm | CSL 51 |
| ● 9/16" | 2 1/16" | |
| ● 16 mm | 63 mm | CSL 61 |
| ● 5/8" | 2 1/2" | |
| ● 18 mm | 75 mm | CSL 78 |
| ● 11/16" | 3" | |

ø 100mm
H : 136mm

ø 4"
H : 5 1/4"



ø 54mm
ø 2 1/8"

TBL 70

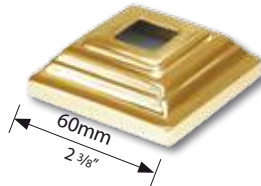

60mm
2 3/8"

| | |
|---------|---------|
| ■ 14 mm | CSL 614 |
| ■ 9/16" | |
| ■ 16 mm | CSL 616 |
| ■ 5/8" | |
| ■ 20 mm | CSL 620 |
| ■ 3/4" | |

Finition

Exemple de combinaison
Combination example
Kombinationsbeispiel
Combinatie voorbeeld
Ejemplo de combinación
Пример комбинации

TABLEAU DES DECLINAISONS (SAUF BL178)
TABLE OF DECLINATIONS (NOT FOR BL178)
DEKLINATIONSTABELLE (NICHT FÜR BL178)
TABEL MED AFVISINGER (NIET VOOR BL178)
TABLA DE DECLINACIONES (NO PARA BL178)
ТАБЛИЦА СКЛОНЕНИЙ (НЕ ДЛЯ BL178)

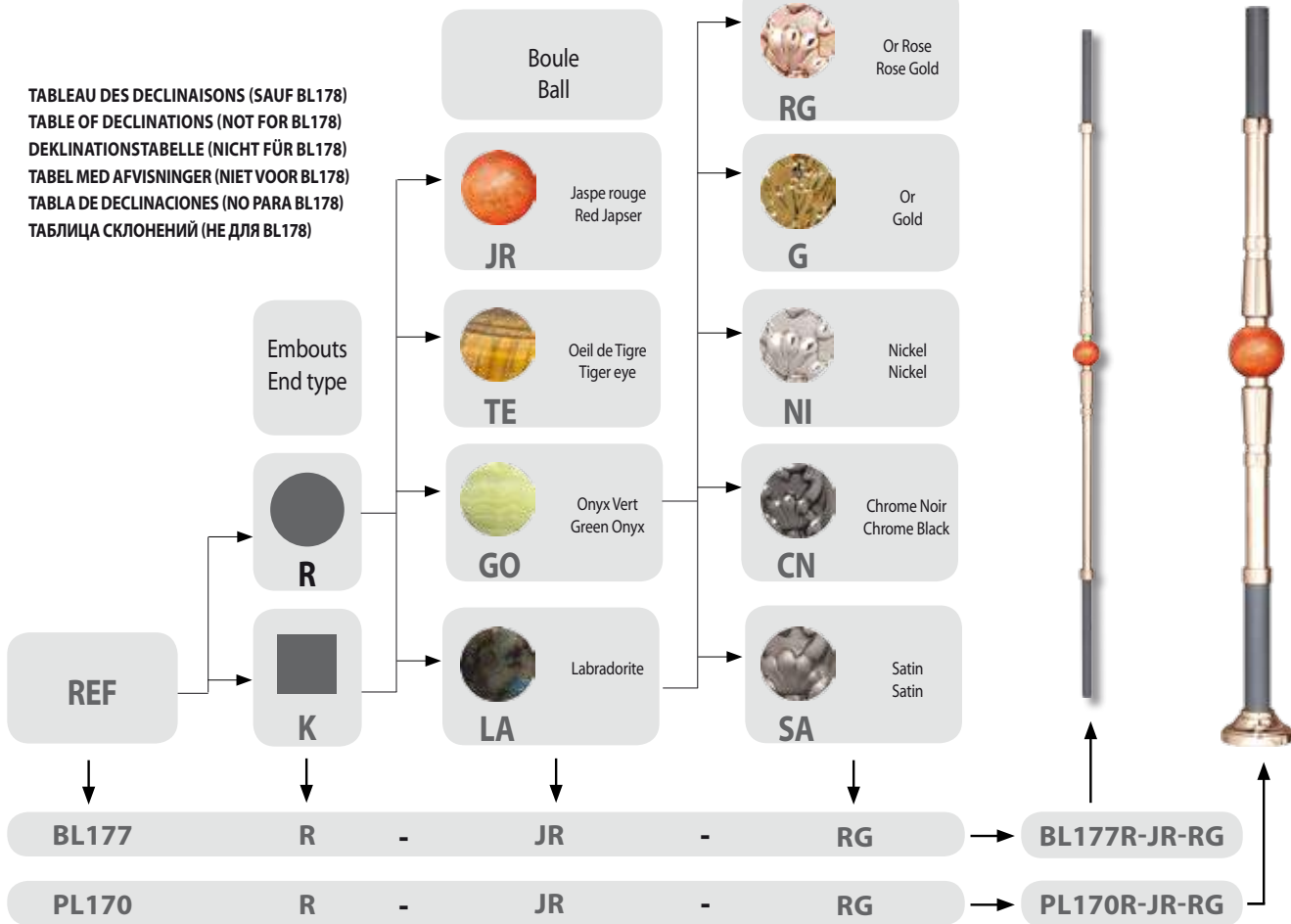

MODERN OR ROSE

ø 95mm
H: 135mm

ø 3 3/4"
H: 5 1/4"



ø 63mm
2 1/2"



● 16mm
5/8" CSL61 RG

TBL 38 RG

ø 54mm
ø 2 1/8"

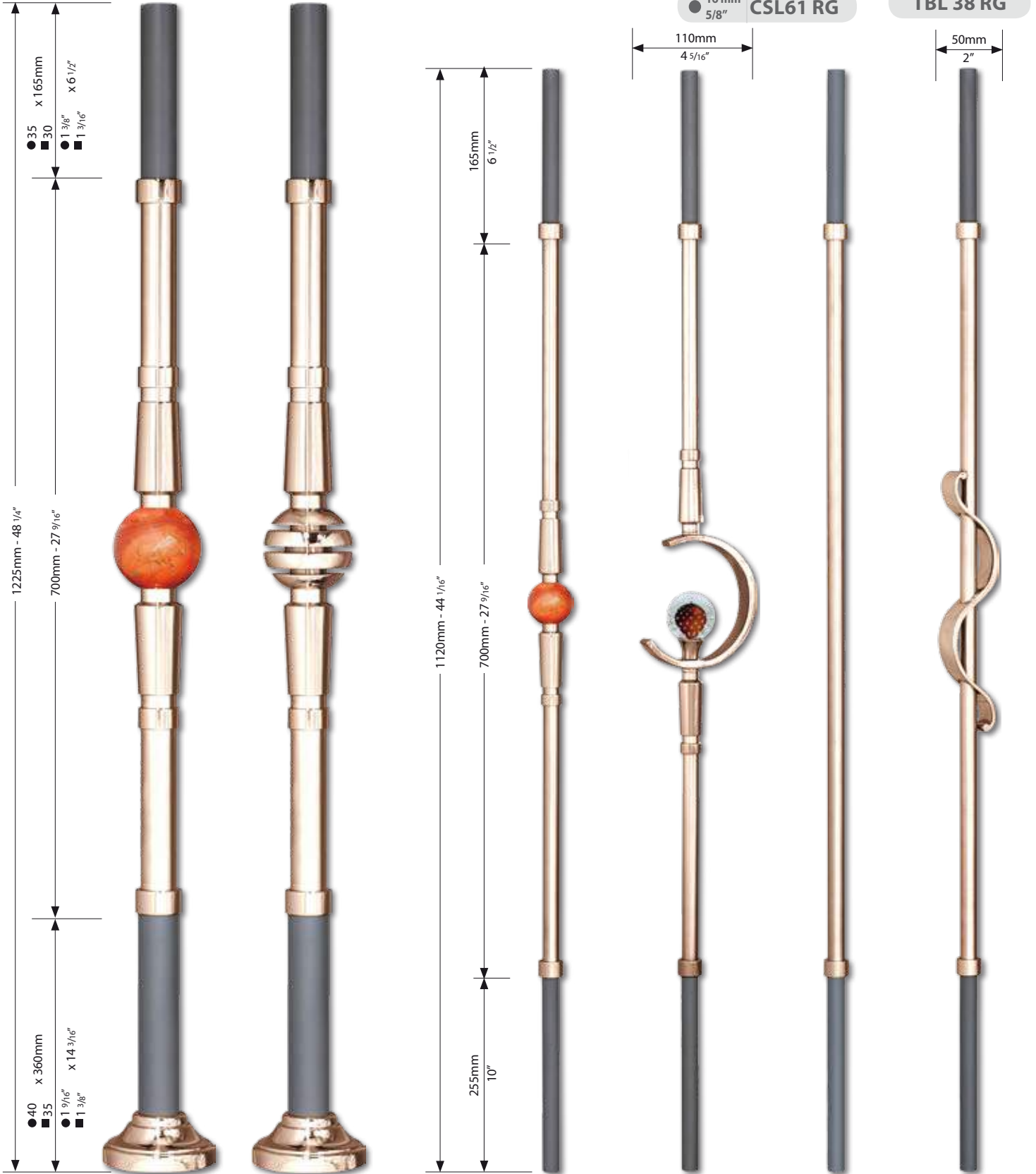

1225mm - 48 1/4"
700mm - 27 9/16"
x 165mm
● 35
■ 30
● 1 3/8"
■ 1 3/16"
x 6 1/2"

1120mm - 44 1/16"
700mm - 27 9/16"
165mm
6 1/2"
255mm
10"

110mm
4 5/16"

50mm
2"

- | | | | | | | | |
|---|--------------|----------|----------------|--------------|----------|----------|----------|
| ● | PL170R-JR-RG | PL170RRG | ● 16mm 5/8" | BL177R-JR-RG | BL178RRG | BL175RRG | BL179RRG |
| ■ | PL170K-JR-RG | PL170KRG | ■ 16mm 5/8" | BL177K-JR-RG | BL178KRG | BL175KRG | BL179KRG |

MODERN SATIN

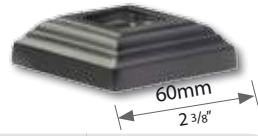

16 mm 5/8" CSL616SA

ø 95mm
H: 135mm



ø 3 3/4"
H: 5 1/4"

ø 54mm
ø 2 1/8"

TBL 53-LA-SA

LAITON

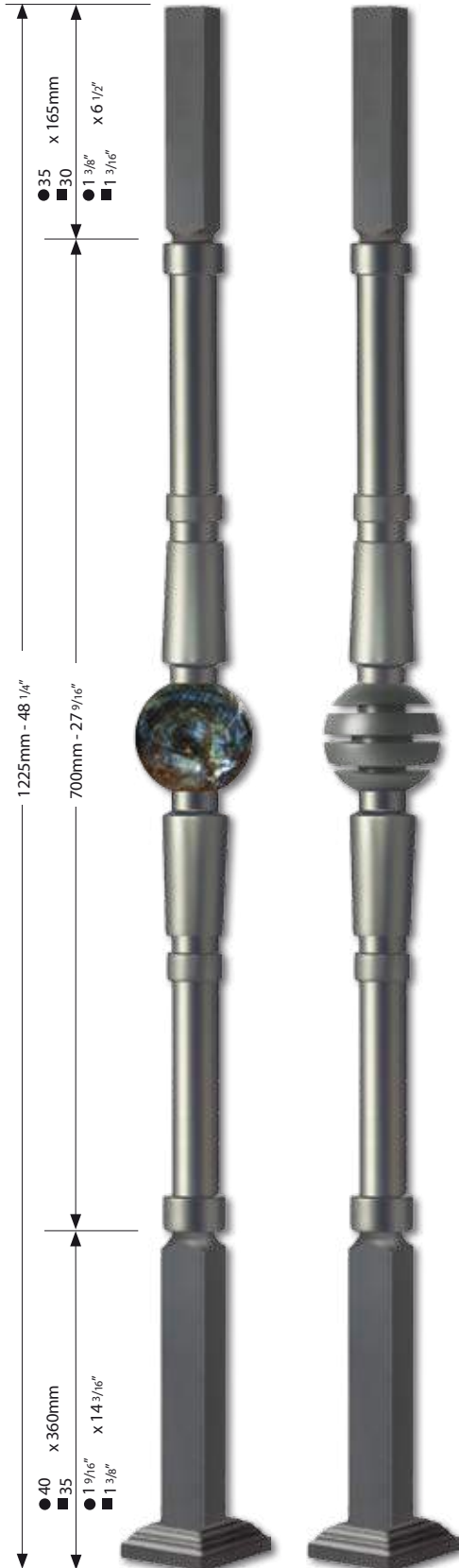

- PL170R-LA-SA PL170RSA
- PL170K-LA-SA PL170KSA

- 16mm 5/8" BL177R-LA-SA BL178RSA BL175RSA BL179RSA
- 16mm 5/8" BL177K-LA-SA BL178KSA BL175KSA BL179KSA

SQUARE

FRANÇAIS : Un mariage entre des lignes épurées et des finitions avec des tonalités chaudes pour cette nouvelle collection qui souffle un vent de modernité. Les barreaux sont en acier inoxydable avec un revêtement PVD (dépôt physique en phase vapeur) de couleur or, nickel, laiton ou encore or rose .

Nous vous proposons une variante avec des embouts en acier carré, permettant le montage de la rampe par soudure.

DEUTSCH : Eine perfekte Verbindung zwischen klaren Linien und warmen Farbtönen für diese neue Kollektion, die einen Hauch von Modernität verbreitet. Die Baluster bestehen aus Edelstahl mit einer PVD-Beschichtung in Gold-, Nickel-, Messing- oder Roségoldfarbe.

Wir bieten eine Variante mit quadratischen Stahlendstücken an, die eine Montage durch Schweißen ermöglichen.

ENGLISH : A perfect union between clean lines and finishes with warm tones for this new collection that blows a wind of modernity. The balusters are made of stainless steel with a PVD coating in gold, nickel, brass or rose gold color).

We offer a variant with square steel endpieces, allowing installation by welding.

ESPAÑOL : Una unión perfecta entre líneas limpias y acabados con tonos cálidos para esta nueva colección que sopla un viento de modernidad. Los balaustres están hechos de acero inoxidable con un revestimiento de PVD en color dorado, níquel, latón u oro rosa).

Ofrecemos una variante con extremos cuadrados de acero, que permite la instalación mediante soldadura.

RUSSE : Идеальное сочетание четких линий и декоративного покрытия в теплых тонах, как веяние свежего ветра современности для этой новой коллекции. Балясины изготовлены из нержавеющей стали с PVD-покрытием (золото, никель, латунь или розовое золото).

Наконечники балясин изготовлены из стали, что позволяет производить сварочные работы.



SQUARE FINITION

ACIER INOXYDABLE
REVETEMENT PVD



G = BL120G

PVD OR



NI = BL120NI

NICKELÉ



RO = BL120RO

OR ROSE



L = BL120L

LAITON

STAINLESS STEEL
PVD COATED

LAITON



BL 120 G



BL 120 L

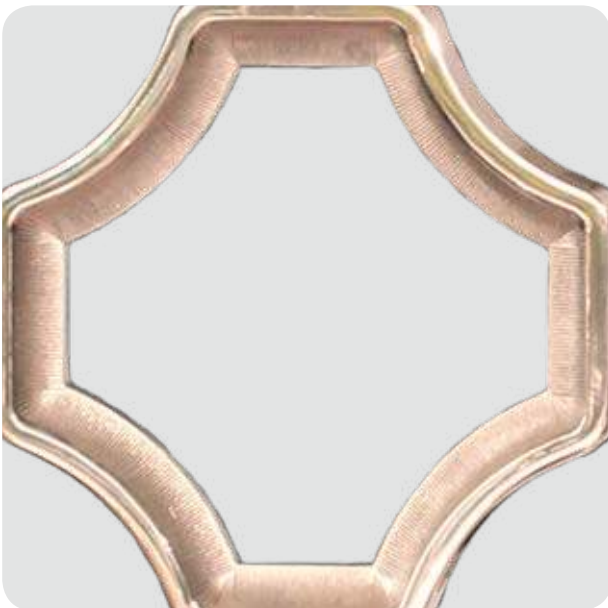

BL 120 RO



BL 120 NI

SQUARE

ACIER INOXYDABLE
REVETEMENT PVD

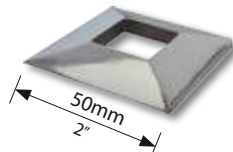

16 mm 5/8" CSKF 16NI

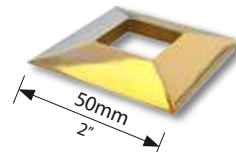

16 mm 5/8" CSKF 16L



PL 122 L PL 122 NI

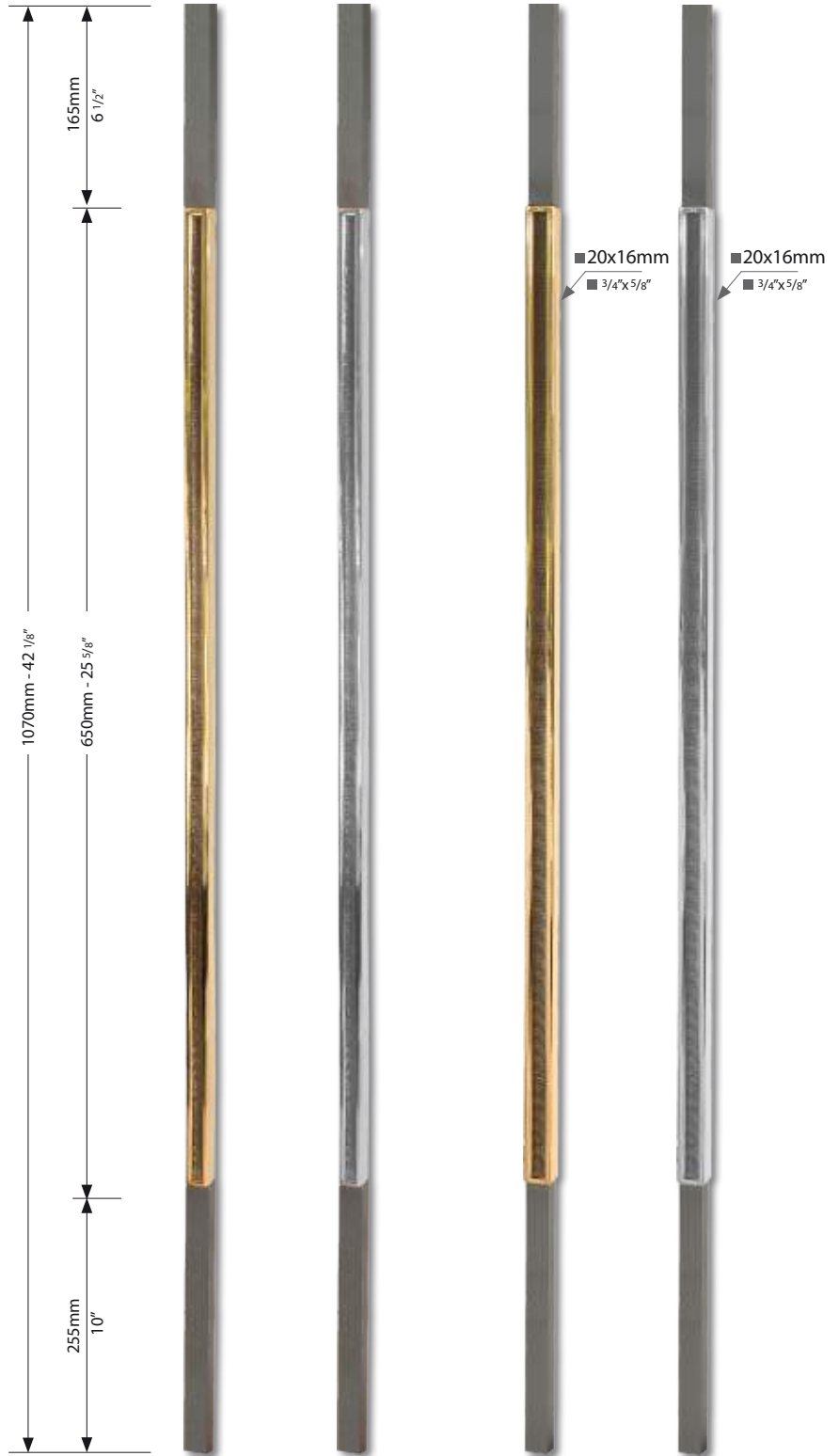

16 mm 5/8" BL 127 L BL 127 NI BL 122 L BL 122 NI

STAINLESS STEEL
PVD COATED

SQUARE

FRANCE
gf
1948



G = BL127G NI = BL127NI L = BL127L RO = BL127RO

LAITON

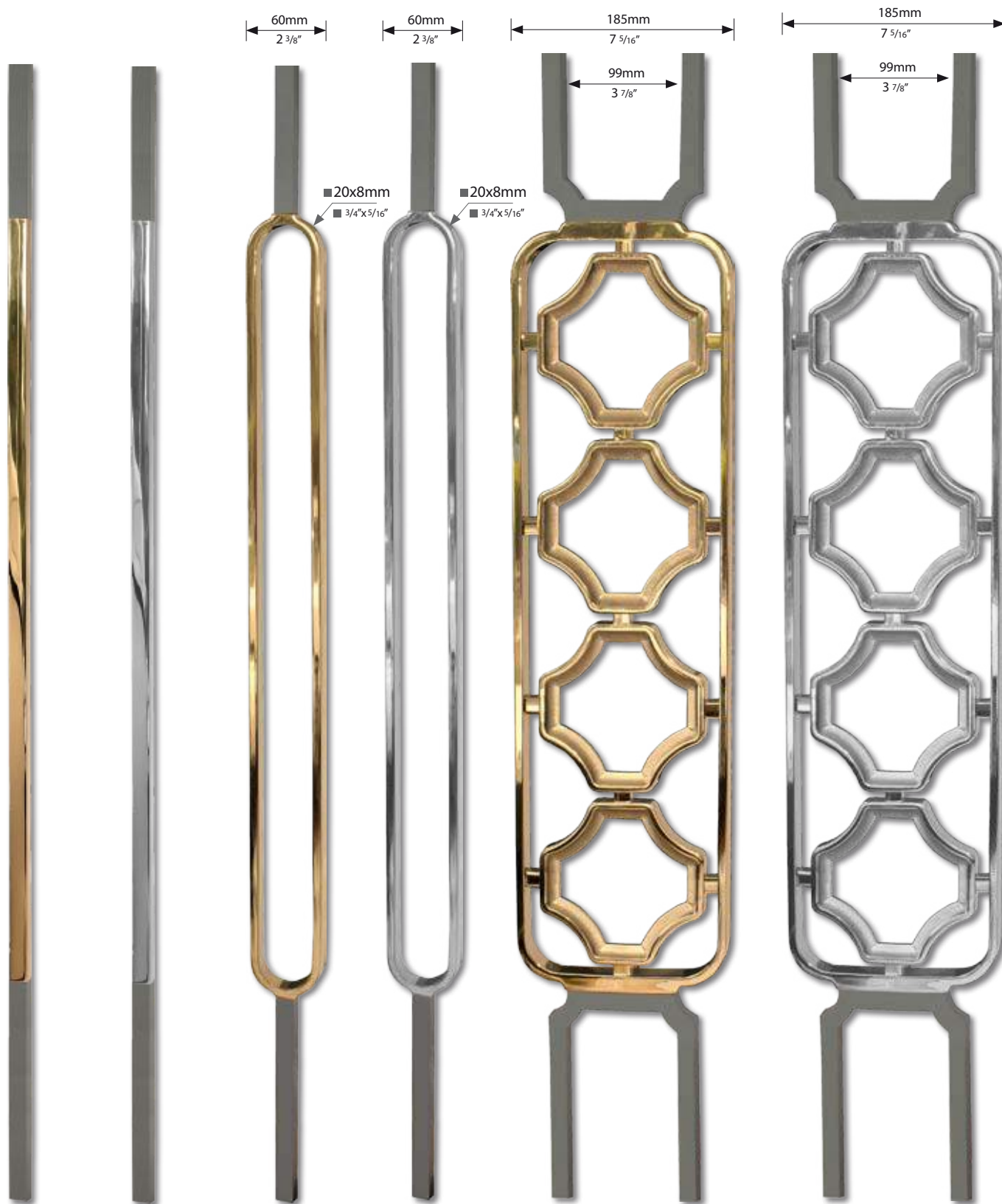

BL 126 L

BL 126 NI

BL 129 L

BL 129 NI

BL 120 L

BL 120 NI

SQUARE FULL

ACIER INOXYDABLE
REVETEMENT PVD

Embout inox - Stütze aus rostfreier Stahl - Stainless steel support - Ondersteuning in roestvrij staal - Contera de acero inoxidable - Нержавеющая сталь

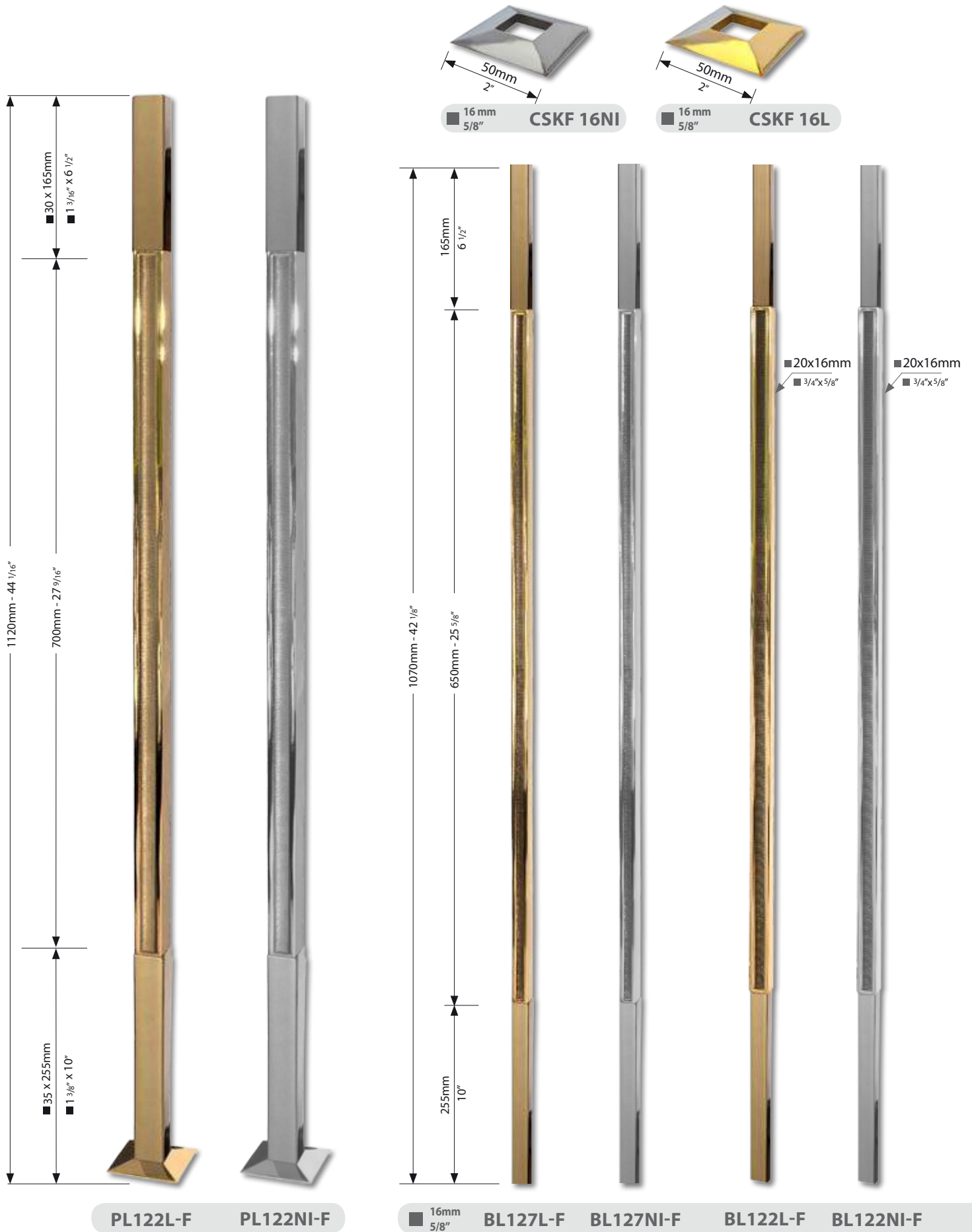

**STAINLESS STEEL
PVD COATED**

SQUARE FULL

Embout inox - Stütze aus rostfreier Stahl - Stainless steel support - Ondersteuning in roestvrij staal - Contera de acero inoxidable - Нержавеющая сталь



G = BL127G-F



NI = BL127NI-F



L = BL127L-F



RO = BL127RO-F

LAITON



BL126L-F

BL126NI-F

BL129L-F

BL129NI-F

BL120L-F

BL120NI-F

VERSAILLES

FRANÇAIS : La série Versailles reflète l'admiration et l'inspiration des grands palais. Elle se caractérise par des lignes nobles et simples, ainsi que par l'équilibre et l'esthétisme de son décor. Les extrémités sont en acier, permettant éventuellement l'assemblage de la rampe par soudure. Ces extrémités, ainsi que les lisses sont à peindre avec une peinture satinée, assortie aux marches et à l'environnement.

Usage exclusif en intérieur.

DEUTSCH : Die Versailles Reihe spiegelt die Bewunderung und Inspiration der großen Palästen wider. Sie zeichnet sich durch ihre adeligen und schlichten Linien, sowie durch die Balance und Ästhetik ihres Dekors aus. Die Endstücke sind aus Stahl, um das Zusammenschweißen des Geländers zu ermöglichen. Die Endstücke und die Untergurte sollten entsprechend der Umgebung mit einem seidenmatten Lack gestrichen werden.

Verwendung ausschließlich für den Innenbereich.

ENGLISH : The Versailles series reveals the admiration and inspiration of the great palaces. It is characterized by noble and simple lines, along with the balance and aestheticism of its decor. The end pieces are made of mild steel, allowing for the assembly of the railing by welding. The ends, as well as the rails, should be painted with a satin finish in a colour suitable to the room decoration.

For indoor use only.

NEDERLANDS : De serie Versailles weerspiegelt de schoonheid en uitstraling van de grote paleizen. Dit straalt zich uit door de adellijke doch eenvoudige lijn, alsmede de balans en de esthetiek van de inrichting. Vervaardigt voor het luxe leven, roepen deze buitengewoon schitterende balusters en sierspijlen, herinneringen op aan vroegere, vorstelijke paleizen.

Daarna zijn de spijlen met een speciale kleurloze lak behandeld. De eindstukken van de spijlen zijn van blank vierkant ijzer, zodat deze kunnen worden gelast of geschroefd aan de boven- en onderprofielen. Zowel de eindstukken als de onder- en bovenprofielen dienen, passend bij het interieur, met een zijdemat lak (niet glanzend) behandeld te worden.

Gebruik: uitsluitend voor interieurs.

ESPAÑOL : La serie Versailles refleja la admiración y la inspiración por los grandes palacios. Sus características son las líneas nobles y simples, así como el equilibrio y el esteticismo de su decoración. Los extremos son de acero permitiendo, si se desea, el montaje de la barandilla por soldadura. Estas extremidades, así como las pletinas superior e inferior, deben ser pintadas con una pintura satinada a juego con los peldaños y el entorno.

Uso exclusivo para interiores.

RUSSE : Новинка Серия ВЕРСАЛЬ отражает восхищение и вдохновение великих дворцов. Она выделяется благородными и одновременно простыми линиями, а также сбалансированным и эстетичным декором. Исключительно для использования в помещении.



VERSAILLES FINITION



G = BL422G



NI = BL422NI



SA = BL422SA



CN = BL422CN



RG = BL422RG



BL 422



BL 422 G



BL 422 CN



BL 422 NI



BL 422 RG



BL 422 SA

VERSAILLES



A=1010 mm
A=39 3/4" **PL 600**
A=1110 mm
A=43 11/16" **PL 660**



Patiné - Patinated
Patinert - Patinado **PL 430**



С патинной

BL 421

BL 422

VERSAILLES



G = BL421G



NI = BL421NI



SA = BL421SA



CN = BL421CN



RG = BL421RG



BL 423

BL 424

Patiné - Patinated
Patiniert - Patinado

BL 420

С патиной

BL 427

VERSAILLES OR ROSE

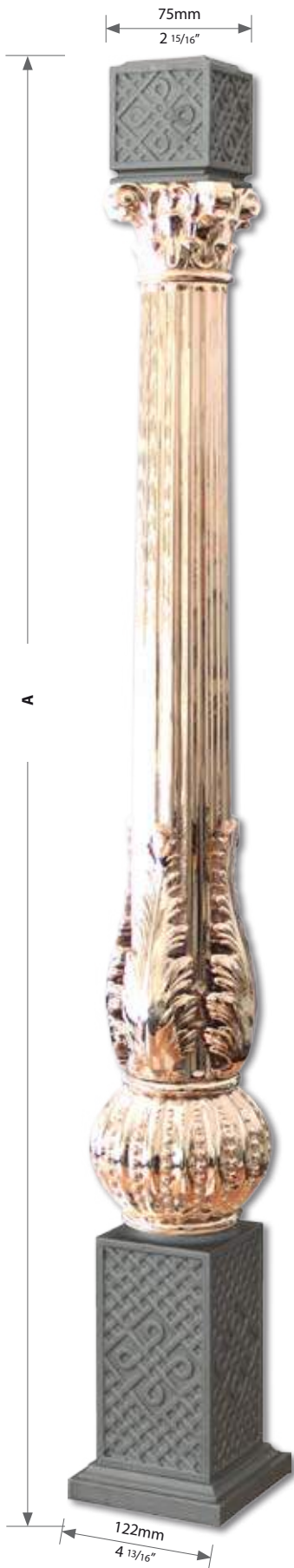

A=1010 mm **PL 600 RG**
 A=39 3/4"
 A=1110 mm **PL 660 RG**
 A=43 11/16"



PL 430 RG



BL 421 RG

BL 422 RG

VERSAILLES OR ROSE



BL 423 RG

BL 424 RG

BL 420 RG

BL 427 RG

VERSAILLES



A=1010 mm
A=39 3/4"
A=1110 mm
A=43 11/16"

PL 600L-F
PL 660L-F



1082mm - 43 5/16"

PL 450



982mm - 39 3/8"

PL 440

Patiné - Patinated
Patiniert - Patinado С патиной

Avec cache-scellement - Mit Abdeckrosette - With base collar - Met afdekrozet - Con pletina - в комплекте с основанием

VERSAILLES



G = BL441G



NI = BL441NI



SA = BL441SA



CN = BL441CN



RG = BL441RG

220mm
8 11/16"

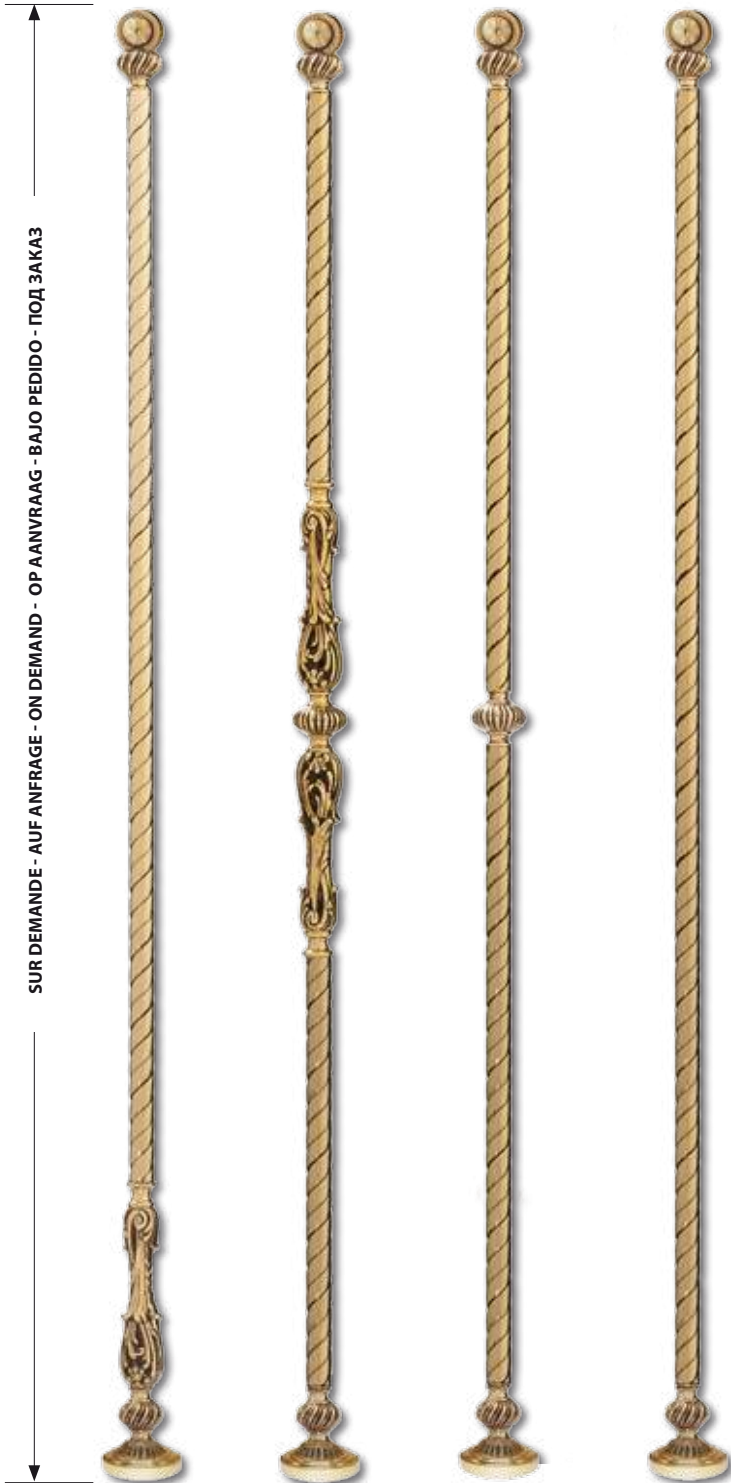

SUR DEMANDE - AUF ANFRAGE - ON DEMAND - OP AANVRAAG - BAJO PEDIDO - ПОД ЗАКАЗ

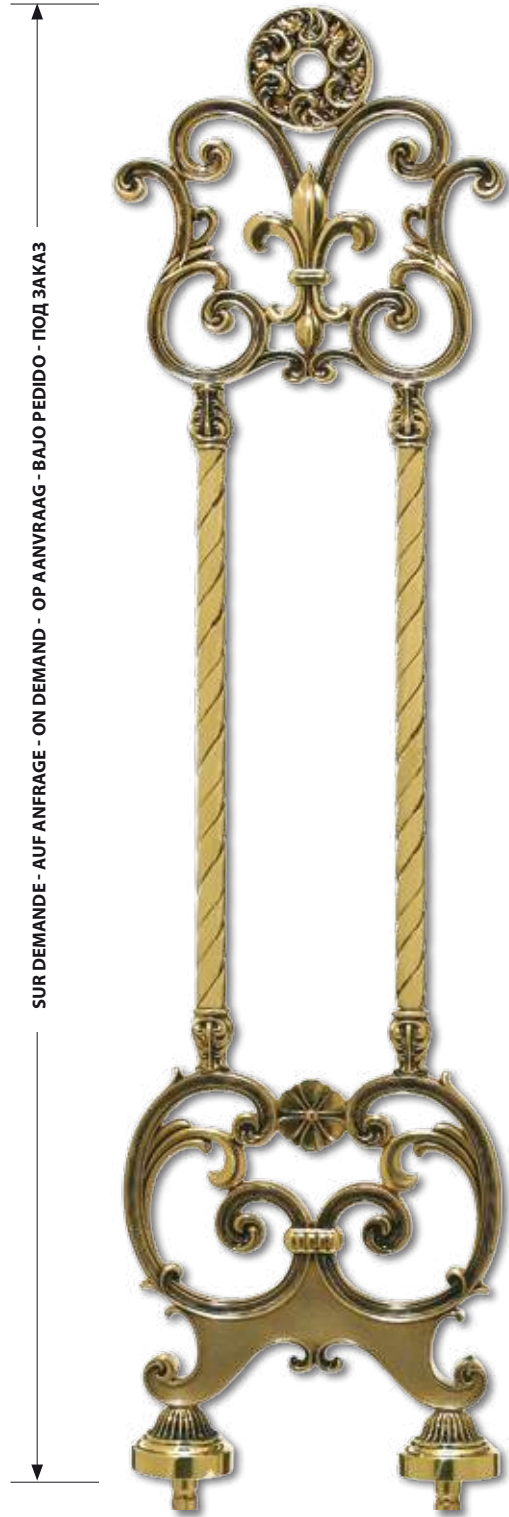

SUR DEMANDE - AUF ANFRAGE - ON DEMAND - OP AANVRAAG - BAJO PEDIDO - ПОД ЗАКАЗ

Avec cache-scellement - Mit Abdeckrosette - With base collar - Met afdekrozet - Con pletina - в комплекте с основанием

BL 441

BL 442

BL 443

BL 444

Patiné - Patinated
Patiniert - Patinado

С патиной

BL 445

ROYAL

FRANÇAIS : Comme son nom l'évoque, la série "ROYAL" recrée le faste et le luxe des anciens palais.

Les extrémités sont en acier, permettant éventuellement l'assemblage de la rampe par soudure. Ces extrémités, ainsi que les lisses sont à peindre avec une peinture satinée, assortie aux marches et à l'environnement.

Usage exclusif en intérieur.

DEUTSCH : Zum Zeichen des Luxus erinnern diese prachtvollen Zierstäbe an frühere fürstliche Paläste.

Die Endstücke sind aus Stahl, um das Zusammenschweißen des Geländers zu ermöglichen. Die Endstücke und die Untergurte sollten entsprechend der Umgebung mit einem seidenmatten Lack gestrichen werden.

Verwendung ausschließlich für den Innenbereich.

ENGLISH : The "ROYAL" series recreates the luxury and the glamour of the ancient palaces.

The end pieces are made of mild steel, allowing for the assembly of the railing by welding. The ends, as well as the rails, should be painted with a satin finish in a colour suitable to the room decoration.

For indoor use only.

NEDERLANDS : Vervaardigt voor het luxe leven, roepen deze buitengewoon schitterende balusters en sierspijlen, herinneringen op aan vroegere, vorstelijke paleizen.

Daarna zijn de spijlen met een speciale kleurloze lak behandeld. De eindstukken van de spijlen zijn van blank vierkant ijzer, zodat deze kunnen worden gelast of geschroefd aan de boven- en onderprofielen. Zowel de eindstukken als de onder- en bovenprofielen dienen, passend bij het interieur, met een zijdemat lak (niet glanzend) behandeld te worden.

Gebruik: uitsluitend voor interieurs.

ESPAÑOL : Como su nombre evoca, la serie "ROYAL" recrea el esplendor y el lujo de los antiguos palacios. Los extremos son de acero permitiendo, si se desea, el montaje de la barandilla por soldadura. Estas extremidades, así como las pletinas superior e inferior, deben ser pintadas con una pintura satinada a juego con los peldaños y el entorno.

Uso exclusivo para interiores.

RUSSE : Серия ROYAL воссоздаёт атмосферу роскоши и очарования старинных дворцов. Окончания изготовлены из стали, что позволяет делать сборку ограждения с помощью сварки. Окончания могут быть окрашены вами матовой краской под цвет ступеней и интерьера. Только для использования внутри помещений. С патиной



ROYAL FINITION



G = BL149G



NI = BL149NI



SA = BL149SA



CN = BL149CN



RG = BL149RG



BL 149



BL 149 G



BL 149 NI



BL 149 SA



BL 149 CN



BL 149 RG

ROYAL



| | | |
|--------------------------|------------------|---------------|
| A=1010 mm A=39 3/4" | PL 600L-F | PL 600 |
| A=1110 mm A=43 11/16" | PL 660L-F | PL 660 |

PL 140

PL 142

Patiné - Patinated
Patinert - Patinado

BL 144

BL 147

ROYAL



G = BL149G



NI = BL149NI



SA = BL149SA



CN = BL149CN



RG = BL149RG



BL 145

BL 148

С патиной

BL 159

Patiné - Patinated
Patiniert - Patinado

BL 149

ROYAL NICKEL PATINÉ

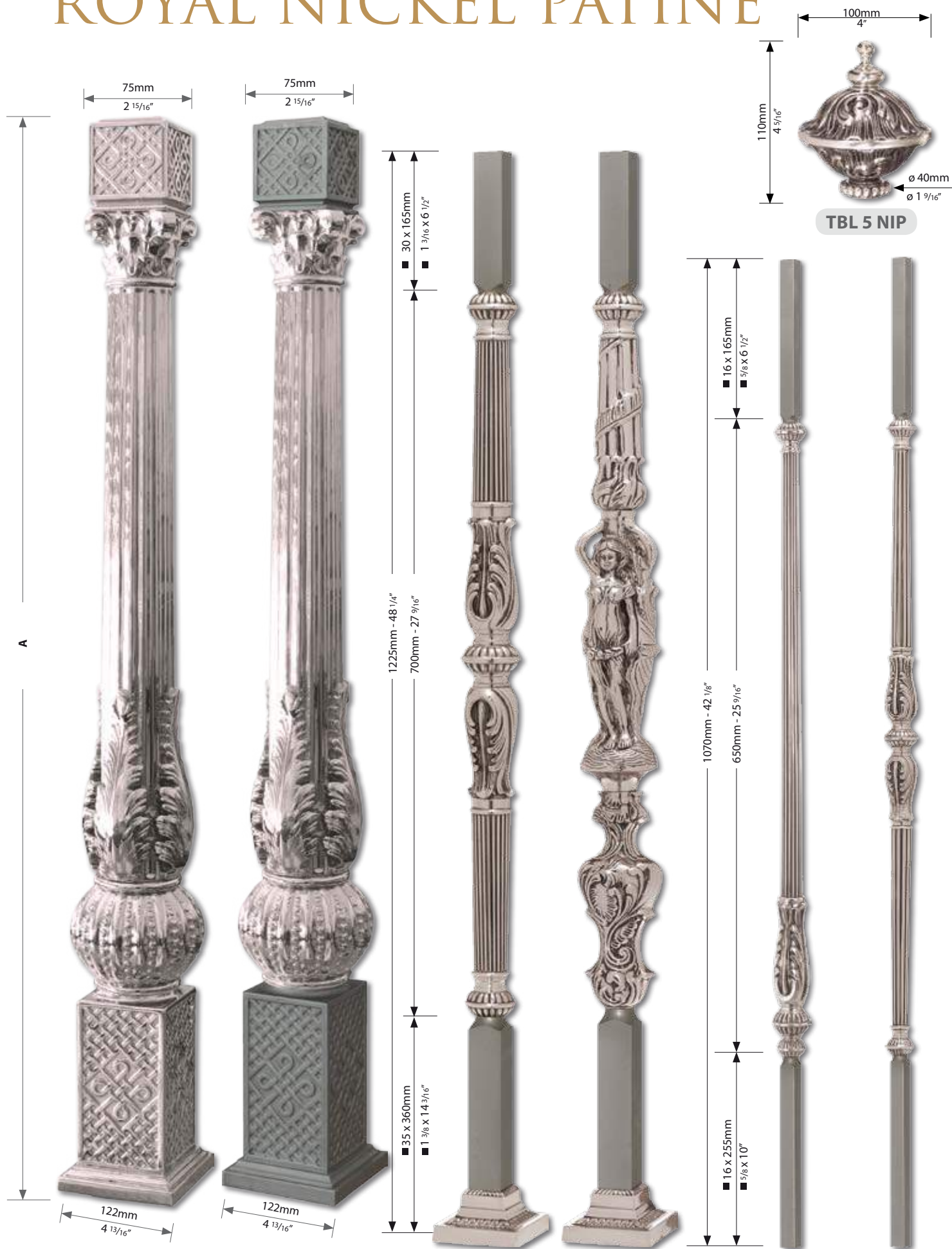

TBL 5 NIP

| | | |
|-------------|--------------------|-------------------|
| A=1010 mm | PL 600NIP-F | PL 600 NIP |
| A=39 3/4" | | |
| A=1110 mm | PL 660NIP-F | PL 660 NIP |
| A=43 11/16" | | |

| | | |
|-------------------|---|-------------------------------------|
| | Patiné - Patinated Patinert - Patinado | Спатиной |
| PL 140 NIP | PL 142 NIP | BL 144 NIP BL 147 NIP |

ROYAL NICKEL PATINÉ

FRANCE
gf
1948

LAITON



BL 145 NIP

BL 148 NIP

Patiné - Patinated
Patiniert - Patinado

BL 159 NIP

С патиной

BL 149 NIP

COMTESSE

FRANÇAIS : D'un style sobre et distingué, la série "COMTESSE" permet des réalisations d'une grande élégance. Les parties centrales en laiton sont polies et vernies. Les extrémités sont en acier brut, permettant ainsi une mise en œuvre facile. Ces extrémités, ainsi que les lisses sont à peindre avec une peinture satinée (pas brillante) assortie à l'environnement. Ces balustres et poteaux sont conçus exclusivement pour l'intérieur.

DEUTSCH : Mit ihrem schlichten edlen Stil wirkt die Serie "COMTESSE" sehr elegant. Die Mittelteile aus Messing massiv sind poliert und lackiert. Die Enden der Stäbe sind aus Stahl und erlauben jede Art der Bearbeitung. Die Endteile sowie der Untergurt sollten mit einem seidenmatten Lack (nicht glänzend) gestrichen werden. Verwendung ausschließlich für den Innenbereich.

ENGLISH : Of a subtle but distinguished style, the "COMTESSE" series presents elegant balusters full of charm. The solid brass bodies are highly polished and protected by a special lacquer. The upper and lower ends are made of mild steel to facilitate cutting, drill-tapping, or welding. These ends, as well as the upper and lower rails, should be painted with a satin finish, (not gloss), in a colour suitable to the room decoration. Balusters and posts are for indoor use only.

NEDERLANDS : Een eenvoudige, doch voortreffelijke stijl bewijst de serie "COMTESSE" door haar vormgeving van elegantie en charme. De middenstukken van massief messing zijn gepolijst en gelakt. De eindstukken van de spijlen zijn van staal en kunnen op allerlei manieren bewerkt worden. Deze eindstukken dienen, passend bij het interieur, met een zijdemat lak (niet glanzend) behandeld te worden. Gebruik : uitsluitend voor interieurs.

ESPAÑOL : De estilo sobrio y distinguido, la serie "COMTESSE" permite ejecuciones llenas de una gran elegancia. Las partes centrales en latón macizo están pulidas, barnizadas y embaladas bajo una protección de plástico que debe permanecer en su sitio hasta la terminación de los trabajos. Los extremos son de acero en bruto lo que permite un fácil mecanizado : taladrado y atornillado o soldado con eléctrica. Los extremos, así como las pletinas superior e inferior, deben pintarse con una pintura satinada (no brillante) a juego con el entorno. Estos balaustres han sido concebidos exclusivamente para el interior.

RUSSE : Изящный и безупречный стиль элегантных стоек серии "ГРАФИНЯ" полон очарования. Латунные стойки великолепно отполированы и покрыты специальным лаком. Для облегчения сборочных работ верхние и нижние окончания изготовлены из стали. Окончания могут быть окрашены вами матовой краской под цвет ступеней и интерьера. Стойки и столбы предназначены только для установки внутри помещений.



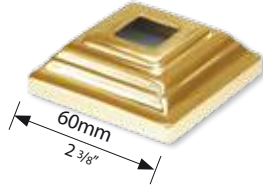

16 mm
5/8" CSL 616



TBL 2

TBL 6

TBL 7

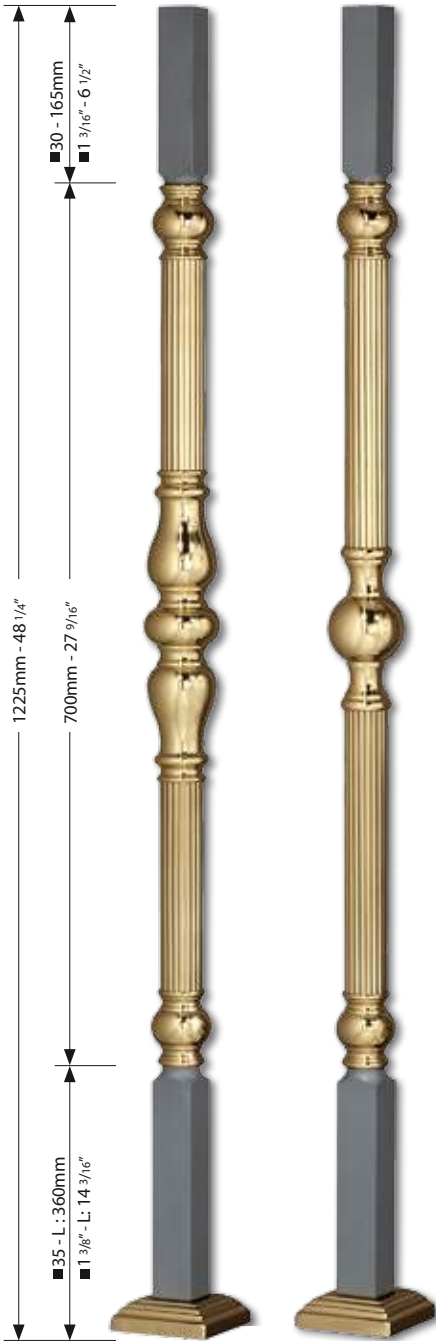

PL 110

PL 111



BL 113

BL 115

BL 116



BL 118

COMTESSE NICKEL



NI = BL113NI



SA = BL113SA



CN = BL113CN

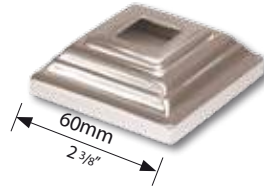

16mm - L: 5/8" CSL 616 NI

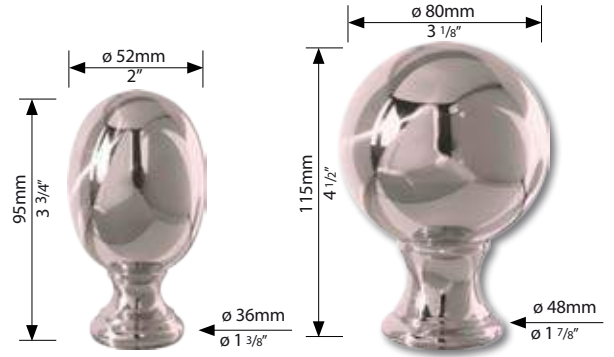

TBL 2 NI

TBL 6 NI



PL 110NI



PL 111NI

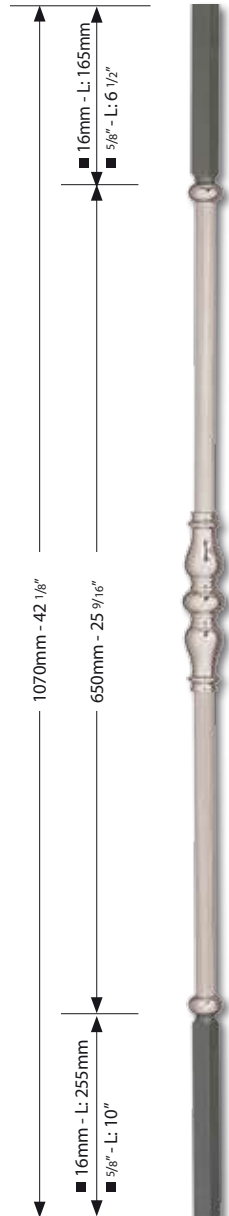

BL 113NI



BL 115NI



BL 116NI



BL 118NI

COMTESSE CHROME NOIR



NI = BL113NI



SA = BL113SA



CN = BL113CN

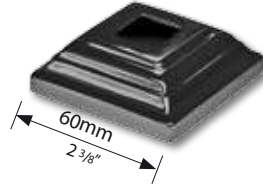

16mm
5/8" CSL 616 CN

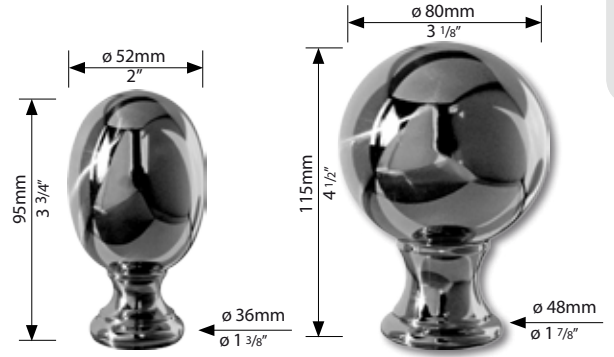

TBL 2 CN

TBL6 CN

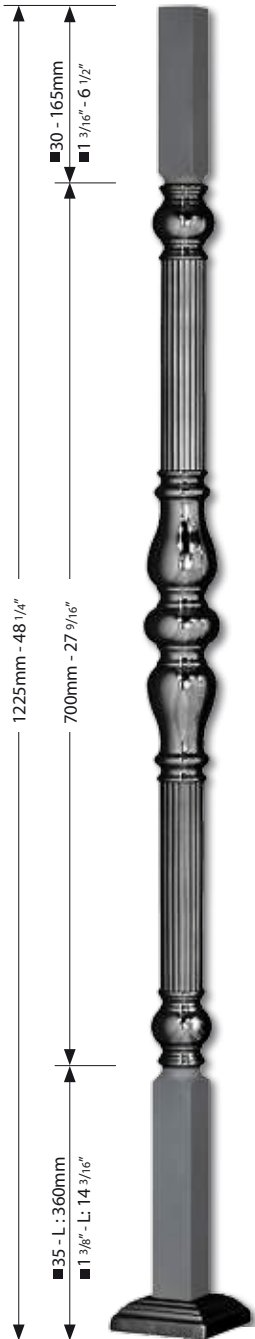

PL 110CN



PL 111CN

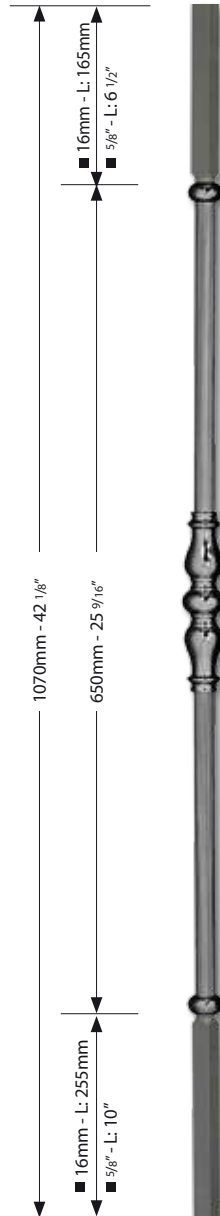

BL 113CN

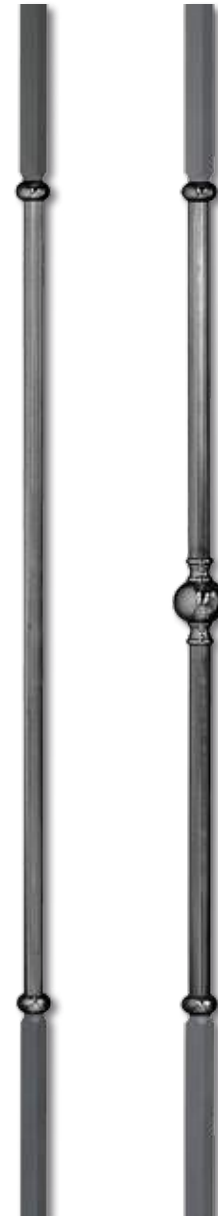

BL 115CN



BL 116CN



BL 118CN

CLASSIC

FRANÇAIS : Née au feu de la forge, la série "CLASSIC" allie la noblesse du **laiton massif** à la rigueur de l'acier forgé. Les rampes et grilles réalisées avec ces balustres sont d'une beauté intemporelle et s'harmonisent à tous les styles. Toutes les parties en laiton sont polies et protégées par un vernis spécial. Produits conçus exclusivement pour l'intérieur.

DEUTSCH : Die im Schmiedefeuer geborene "CLASSIC" Serie verbindet den Adel des **Messings** mit der Strenge des Schmiedeeisens. Die mit diesen Stäben angefertigten Geländer und Gitter sind von einer zeitlosen Schönheit und passen zu jedem Stil. Wir empfehlen diese Teile nur für den Innenbereich zu verwenden.

ENGLISH : Born in the hearth of the forge, the "CLASSIC" series blends the nobility of **solid brass** with the rigour of forged steel. Balustrading and security doors built with these elegantly proportioned balusters have an intrinsic beauty that is timeless and compatible with both contemporary and traditional interior decors. All brass parts are highly polished and protected by a special lacquer. Items for indoor use only.

NEDERLANDS : De in smeedvuur geboren "CLASSIC" serie verbindt de adel van het **messing** met de hardheid van het smeedijzer. Trapleuningen en balustrades die met deze spijlen zijn uitgevoerd, zijn van een tijdloze schoonheid en passen bij iedere stijl. Gebruik : uitsluitend voor interieurs.

ESPAÑOL : Nacida del fuego de la forja, la serie "CLASSIC" combina la nobleza del **latón macizo** con la severidad del hierro forjado. Las barandillas y verjas realizadas con estos balaustres son de una belleza clásica y armonizan con todos los estilos. Todas las partes en latón están pulidas y protegidas por un barniz especial. Productos exclusivamente para el interior.

RUSSE : Стиль серии КЛАССИК, созданный в самом горниле кузницы, сочетает благородство вставок из массивной латуни со строгостью кованой стали. Ограждения и решётки, собранные из этих стоек с элегантными пропорциями, настолько хороши, что прекрасно вписываются как в модернистские, так и в классические интерьеры. Все латунные элементы отполированы до блеска и защищены



CLASSIC

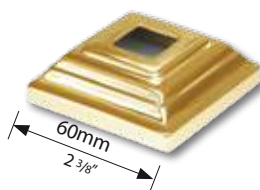

■ 14 mm
9/16" CSL 614



TBL 7

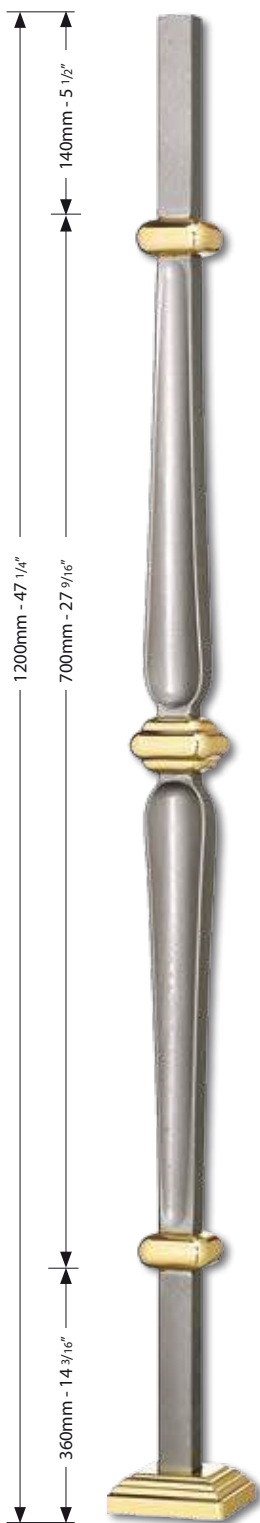

■ 25mm
1" PC 616

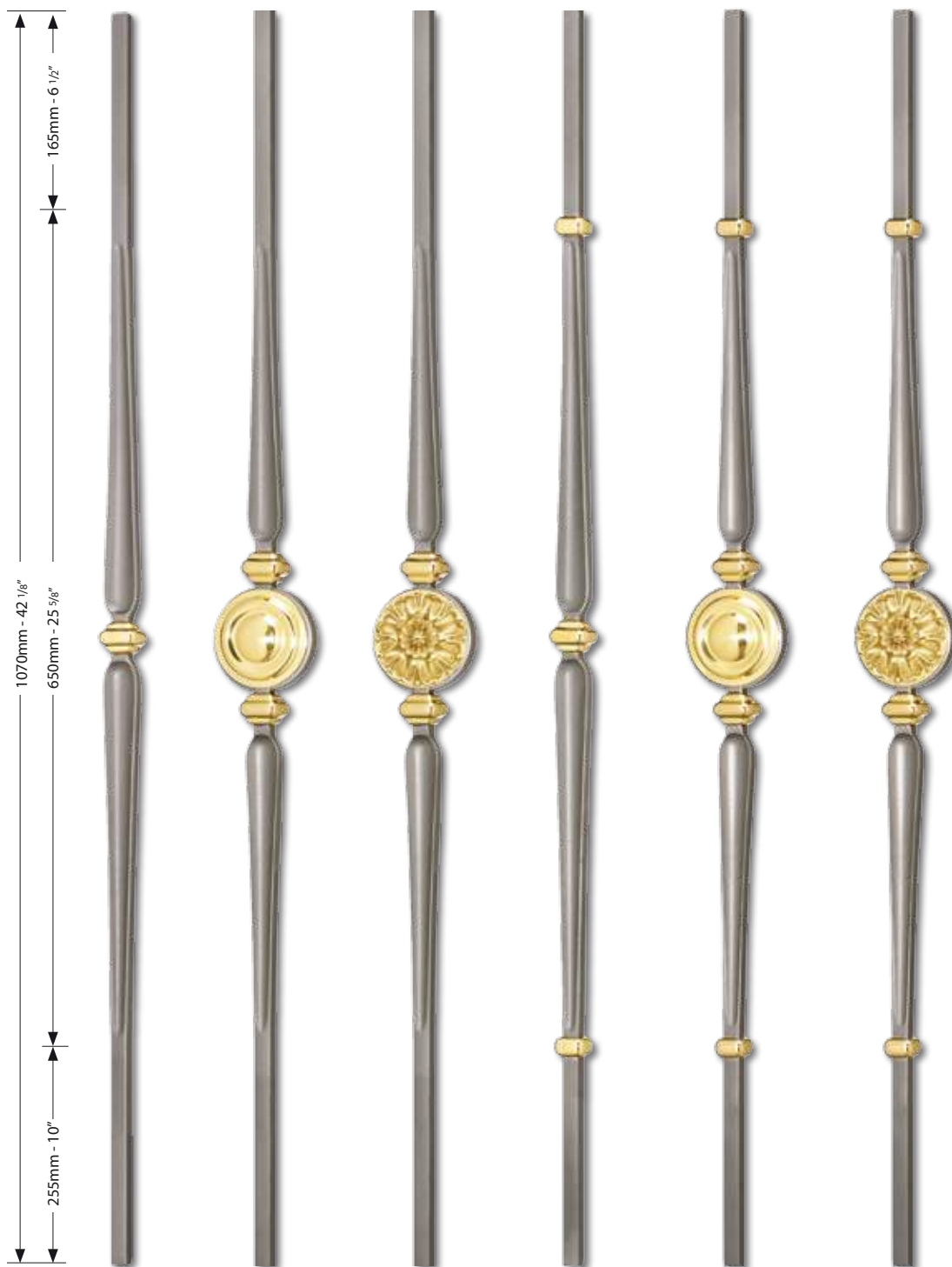

■ 14mm
9/16" B 6105

B 6505

B 6705

B 6106

B 6506

B 6706

CLASSIC

FRANÇAIS : Découvrez la nouvelle version de la célèbre gamme Classic. Les parties centrales sont en **acier inoxydable** poli verni. Le corps du barreau est en acier brut ou peint noir mat.

DEUTSCH : Entdecken Sie die neue Version unserer berühmten Classic Reihe. Die Mittelteile sind aus poliertem und lackiertem **Edelstahl**.

ENGLISH : Discover the new version of the famous Classic range. The central parts are supplied in polished and lacquered **Stainless Steel**. The body of the baluster is raw steel or painted matt black.

NEDERLANDS : Ontdek de nieuwe versie van beroemde klassieke lijn. De middendelen zijn samengesteld uit gepolijst en gelakt **roestvrijstaal**.

ESPAÑOL : Descubra la nueva versión de la célebre gama Classic. Las partes centrales son de **acero inoxidable** pulido y barnizado.

RUSSE : Откройте для себя новую версию уже ставшей знаменитой КЛАССИК серии. Центральные части выполнены из полированной нержавеющей стали и покрыты лаком. Корпус балясины выполнен из стали и окрашен в чёрный матовый цвет.



CLASSIC



HARMONIE

FRANÇAIS : D'une esthétique plus moderne la série "HARMONIE" se distingue particulièrement par sa finition bicolore : "Laiton-Inox". Après vernissage, la partie centrale est emballée sous un film plastique qui doit rester en place jusqu'à la fin des travaux. Les extrémités sont en fer rond brut, permettant ainsi l'assemblage de la rampe par soudure à l'arc ou vissage. Ces extrémités ainsi que les lisses sont à peindre avec une peinture mate ou satinée, assortie à la décoration environnante. Produits conçus exclusivement pour l'intérieur.

DEUTSCH : Durch eine moderne Ästhetik zeichnet sich die Serie "HARMONIE" mit ihrer zweifarbigen Fertigung "Messing-Edelstahl" aus. Nach Lackierung werden die Mittelteile in eine starke Plastikfolie verpackt, die erst nach Beendigung der Montage entfernt wird. Die Endstücke sind aus Rundeisen und ermöglichen jede Art der Bearbeitung, z.B. Bohren, Gewindeschneiden, Elektroschweißen. Die Endstücke sowie der Untergurt sollten mit einem seidenmatten Lack (nicht glänzend) gestrichen werden. Wir empfehlen diese Teile nur für den Innenbereich zu verwenden.

ENGLISH : Of a more modern aesthetic, the "HARMONIE" series is particularly distinguished by its two-colour finish : "Brass-Stainless Steel". After varnishing, the bodies are wrapped in a plastic sheet, which must be kept on until work is completed. The ends are made of mild round steel, allowing for the assembly of the railing by welding or screwing. These ends as well as the upper and the lower rails should be painted with a satin finish (not gloss) in a colour suitable to the room decoration. Items for indoor use only.

NEDERLANDS : De "HARMONIE" serie onderscheidt zich in het bijzonder door de afwerking in twee kleuren : "Messing-Stainless Steel". Na het polijsten en lakken worden de spijlen in een plastic koker verpakt, die pas na montage verwijderd mag worden. De boven- en onderstukken zijn van rond ijzer, niet behandeld i.v.m. verdere verwerking van de spijlen (zoals zagen, boren, lassen etc.) Deze eindstukken dienen, passend bij het interieur, met een zijdemat lak (niet glanzend) behandeld te worden. Gebruik : uitsluitend voor interieurs.

ESPAÑOL : Dentro de una estética mas moderna la serie "HARMANONIA" se distingue particularmente por su acabado en dos tonos : "Latón-Acero inoxidable". Después de ser barnizada la parte central, se embala con una lámina de plástico que debe permanecer en su sitio, hasta el final de los trabajos. Los extremos son de hierro redondo en bruto, permitiendo el fácil ensablaje de las barandillas, por soldadura al arco o bien atornillado. Los extremos asi como las partes lisas, deben pintarse con una pintura satinada (no brillante) a juego con el entorno. Productos exclusivamente para el interior.

RUSSE : Стойки серии ГАРМОНИЯ, для которых характерна более современная эстетика, выделяются своей двухцветной отделкой "латунь – никель". После нанесения лака стойки оборачивают пластиковой пленкой, которую следует снимать только по окончании сборки. Окончания изготовлены из стали, что позволяет приваривать или привинчивать ограждение (перила) при сборке. Окончания могут быть окрашены вами матовой краской под цвет ступеней и интерьера. Для использования только в помещении.



HARMONIE

LAITON



14 mm
9/16" **CSL 51**

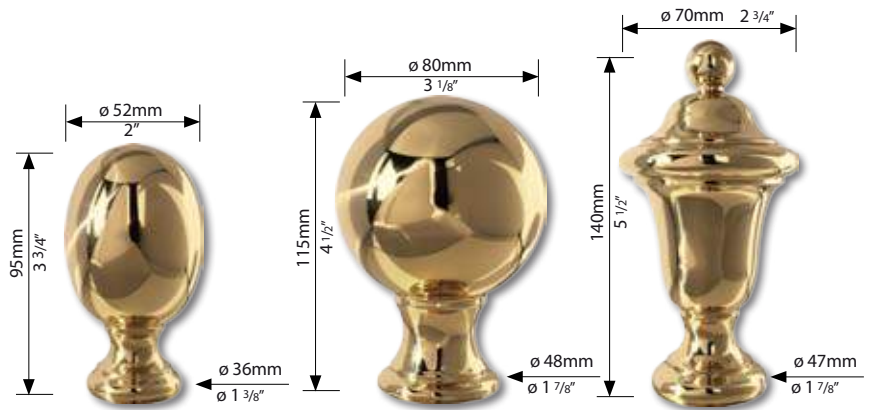

TBL 2 **TBL 6** **TBL 7**

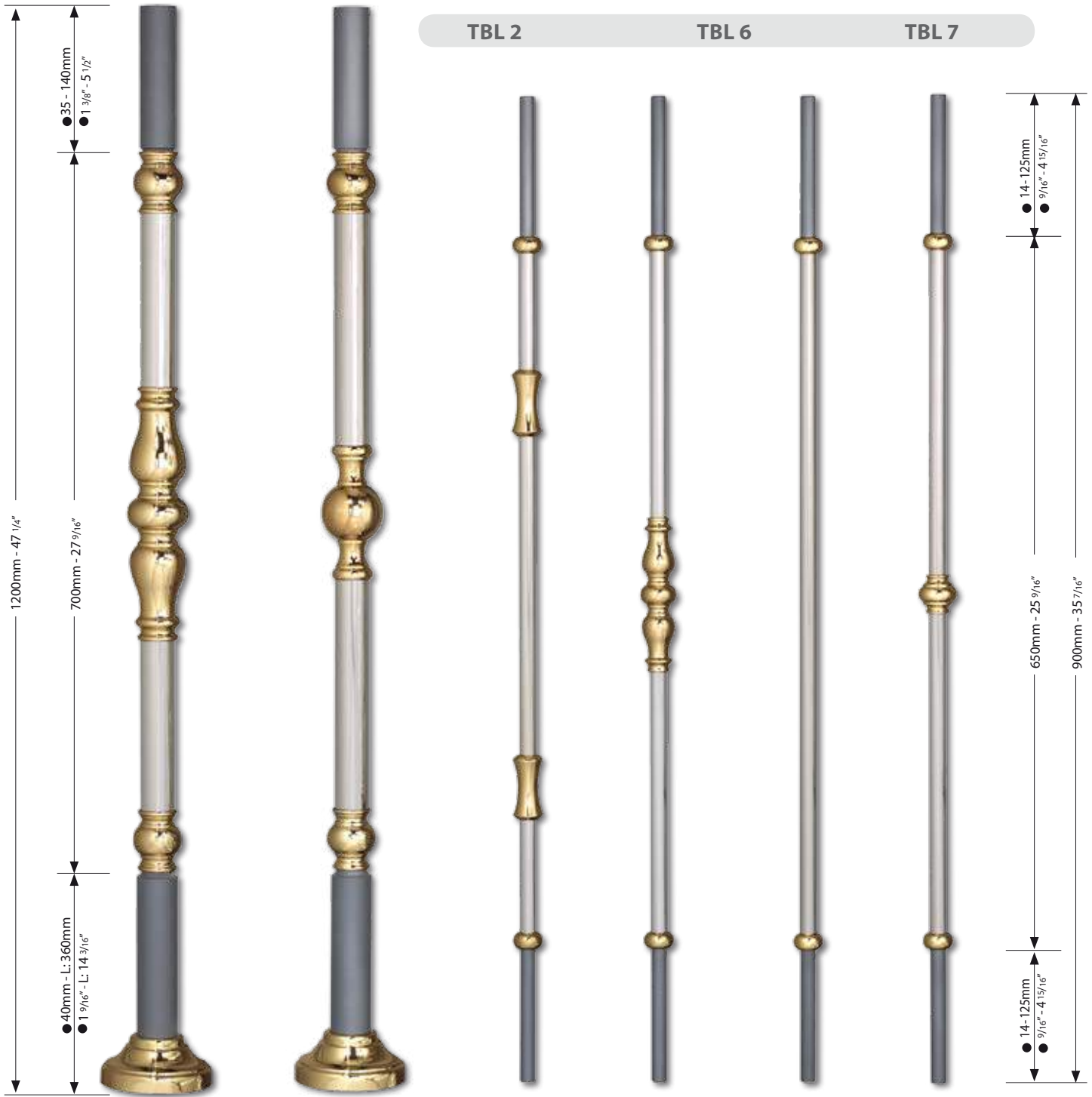

1200mm - 47 1/4"
700mm - 27 9/16"
35 - 140mm
1 3/8" - 5 1/2"
40mm - L: 360mm
1 9/16" - L: 14 3/16"

14-125mm
9/16" - 4 15/16"
650mm - 25 9/16"
900mm - 35 7/16"

PL 100 **PL 101** **BL 102** **BL 103** **BL 105** **BL 107**

HARMONIE NICKEL



● 14 mm
● 9/16" **CSL 51 NI**



TBL 2 NI

TBL 6 NI

TBL 7 NI

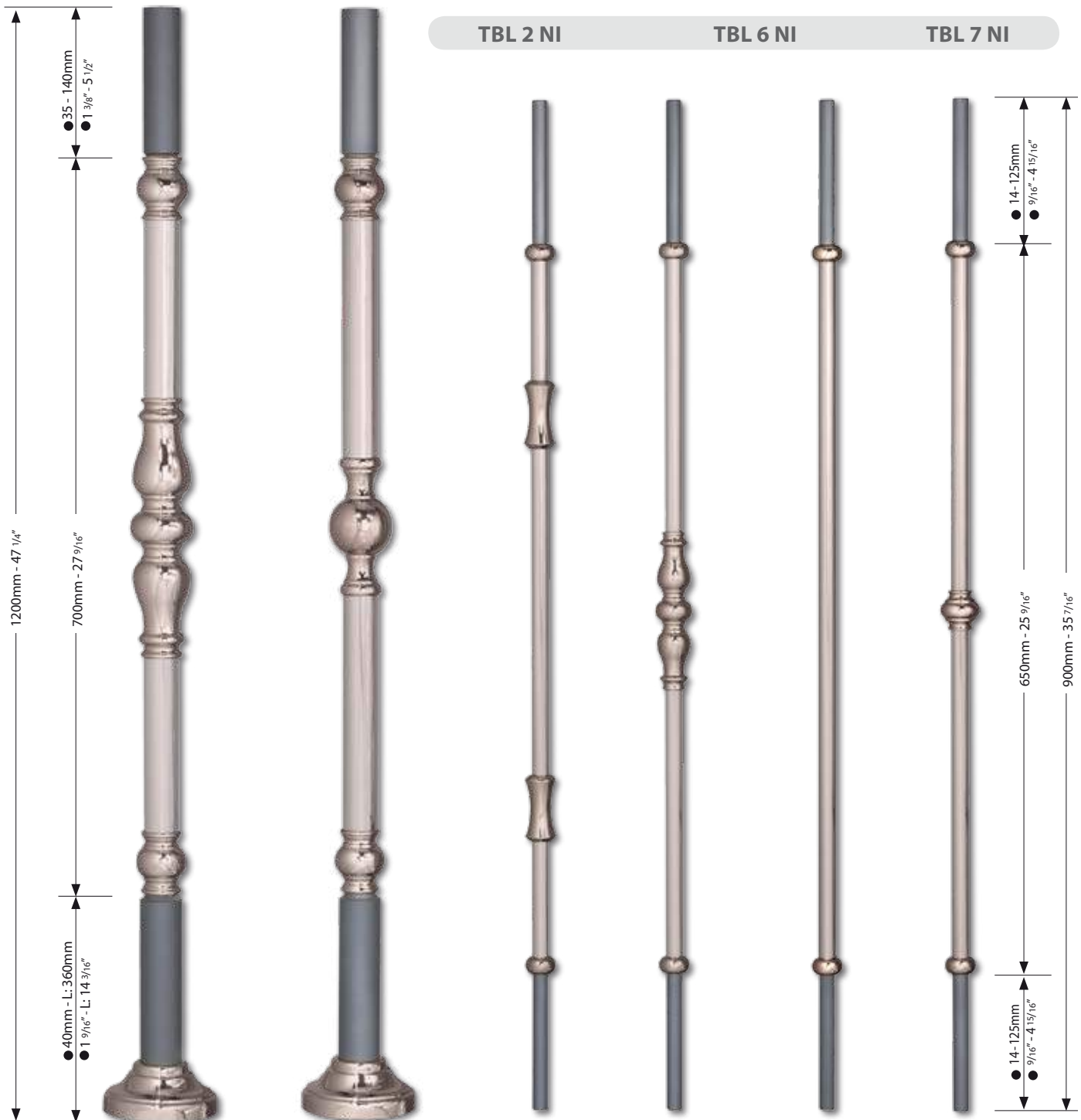

PL 100 NI

PL 101 NI

BL 102 NI

BL 103 NI

BL 105 NI

BL 107 NI

HARMONIE FULL NICKEL

Embout acier nickelé - Stütze aus vernickelter Stahl - nickelated steel support - Ondersteuning in vernikkeld staal - Contera de acero niquelado - никелевая стальная опора

LAITON

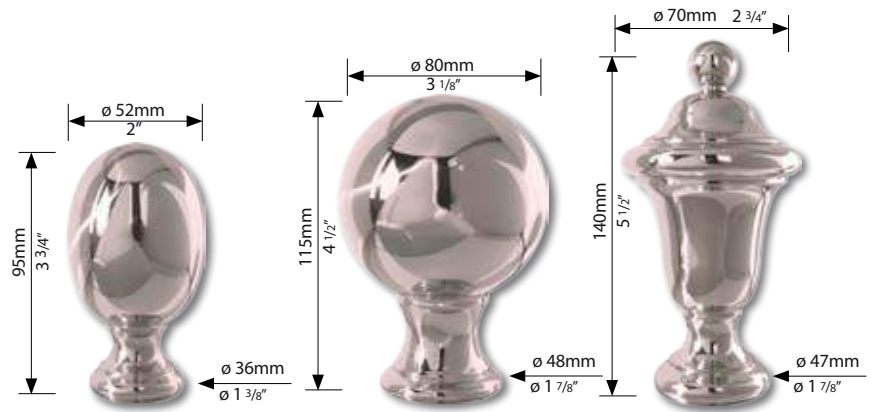

TBL 2 NI

TBL 6 NI

TBL 7 NI



PL100NI-F

PL101NI-F

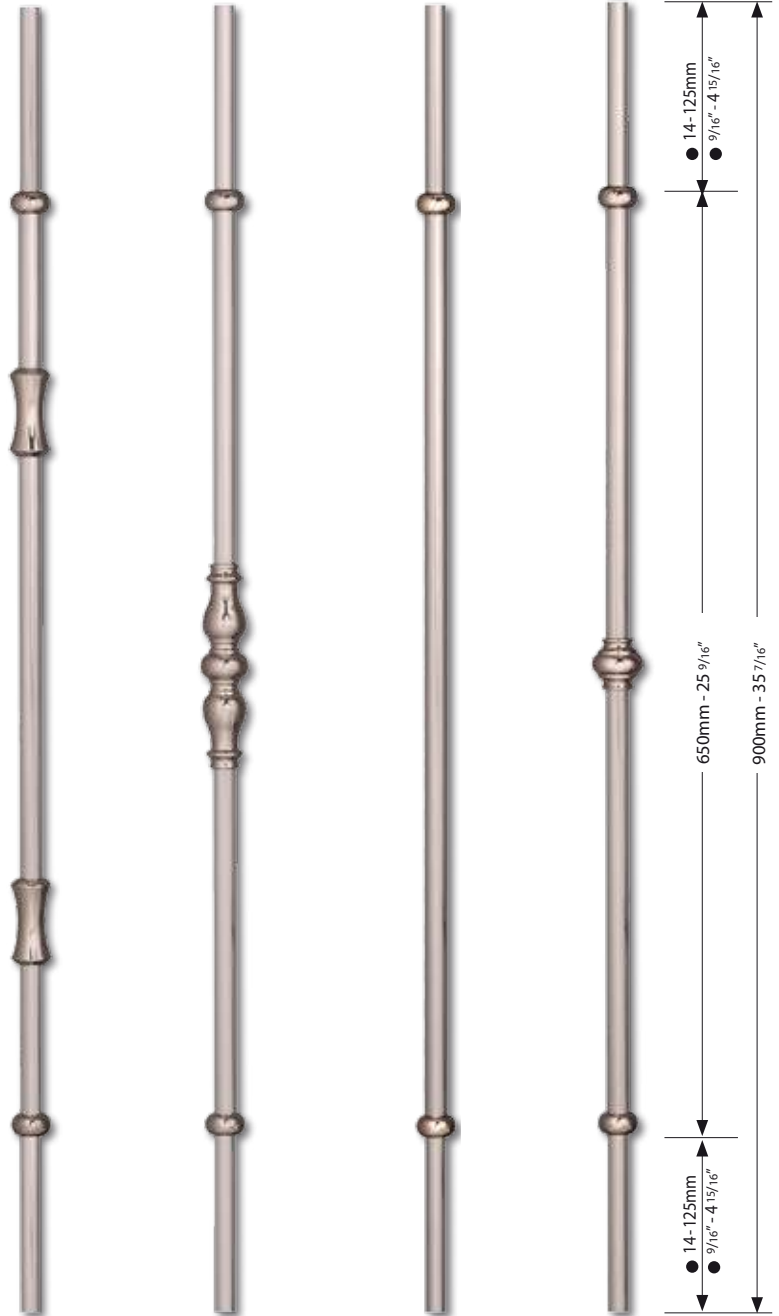

BL102NI-F

BL103NI-F

BL105NI-F

BL107NI-F

ACCESSOIRES - ZUBEHÖR - ACCESSORIES TOEBEHOREN - ACCESORIOS - АКЦЕССУАРЫ

FRANÇAIS : Manchons décoratifs en laiton poli et verni. A monter sur barres rondes. Ils sont équipés d'une vis de blocage M 3 permettant un montage facile et rapide. Produits conçus exclusivement pour l'intérieur.

DEUTSCH : Messing-Zierhülsen, für Rundstäbe, poliert und lackiert. Die M 3 Blockierschraube erlaubt eine einfache und rasche Montage. Wir empfehlen diese Teile nur für den Innenbereich zu verwenden.

ENGLISH : Decorative brass sleeves polished and lacquered, to fit on round bars. They are equipped with an M 3 locking screw to allow for a fast and easy mounting. Items for indoor use only.

NEDERLANDS : Messing sierhulzen, gepolijst en gelakt. Voorzien van een M 3 blokkeerschroefje om de sierhuls vast te zetten. Gebruik : uitsluitend voor interieurs.

ESPAÑOL : Macollas decorativas en latón pulido y barnizado para montar en barras redondas. Equipadas con tornillo de fijación que permiten un montaje fácil y rápido. Productos exclusivamente para el interior.

RUSSE : Отполированные и покрытые лаком декоративные латунные вставки надеваются на круглые стержни. Для ускорения и упрощения сборки вставки оснащены стопорными винтами с резьбой М3. Для использования только в помещении.

ML 11 14mm 9/16"
ML 12 16mm 5/8"

ML 141 14mm 9/16"
ML 142 16mm 5/8"

ML 21 15mm - 9/16"
ML 22 20mm - 3/4"

ML 185 14mm 9/16"
ML 186 16mm 5/8"

MLP 245 245mm 9 5/8"

MLP 285 310mm 12 1/4"

MLP 70 30mm 1 3/16"

ML 31 14mm 9/16"
ML 32 16mm 5/8"

ML 61 35mm - 1 3/8"
ML 62 60mm 2 3/8"

ML 25 14mm 9/16"
ML 26 16mm 5/8"

MLP 45 30mm 1 3/16"

RL 9 85mm 3 3/8"

RL 7 72mm 2 13/16"

RL 75 75mm 3"

FRANÇAIS : Rosaces en laiton avec filetage M 6. Produits conçus exclusivement pour l'intérieur.

DEUTSCH : Messing-Rosetten, mit M 6 Gewinde. Wir empfehlen diese Teile nur für den Innenbereich zu verwenden.

ENGLISH : Brass rosettes with an M 6 threaded hole. Items for indoor use only.

NEDERLANDS : Messing rozetten. Met M 6 draadgat. Gebruik : uitsluitend voor interieurs.

ESPAÑOL : Rosetón en latón con taladro roscado M 6. Productos exclusivamente para el interior.

RUSSE : Латунные розетки с резьбовым отверстием М6. Для использования только в помещении.



G = BL441G



NI = BL441NI



SA = BL441SA



CN = BL441CN



RG = BL441RG



● 30 mm 1 3/16" **MLP145NI**



● 14mm 9/16" **ML141NI**
● 16mm 5/8" **ML142NI**



● 14mm **ML11NI**
● 16mm **ML12NI**



ML21NI
ML22NI



● 14mm 9/16" **ML185NI**
● 16mm 5/8" **ML186NI**



● 30 mm 1 3/16" **MLP285NI**



● 30 mm 1 3/16" **MLP70NI**

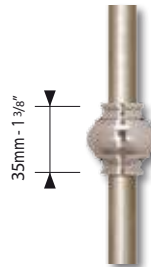

● 14mm 9/16" **ML31NI**
● 16mm 5/8" **ML32NI**



ML61NI
ML62NI

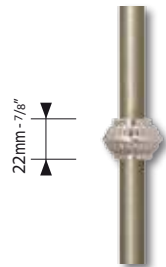

● 14mm 9/16" **ML25NI**
● 16mm 5/8" **ML26NI**

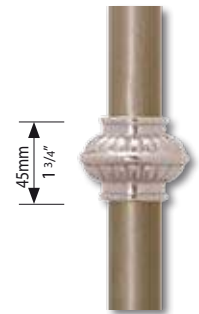

● 30 mm 1 3/16" **MLP45NI**

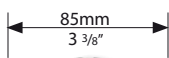

RL 9 NI

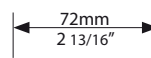

RL 7 NI

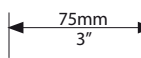

RL 75 NI

PINCES DE FIXATION - GLASHÄLTER - GLASS CLIPS GLASKLEM - PINZAS DE FIJACION - СТЕКЛОДЕРЖАТЕЛЬ



FRANÇAIS : Pince de fixation en laiton.
DEUTSCH : Messing Glashalter.
ENGLISH : Brass glass clip.
NEDERLANDS : Messing glasklem.
ESPAÑOL : Pinza de fijación de latón.
RUSSE : Стеклодержатель из латуни.

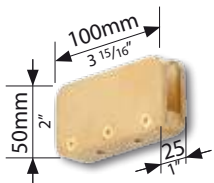

Ep. Max 12 mm

GC 8050*

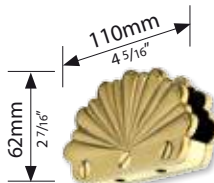

Ep. Max 12 mm

GC 8150*

FRANÇAIS : Pince de fixation décorée polie vernie avec embout fer.

GC8250L : embout laiton. Utilisation conseillée avec les cache-scelllements ci contre CSL 648 et CSL 403.

DEUTSCH : Ziselierter Glasshalter poliert und lackiert mit Stütze aus Stahl.

GC8250L : Stütze aus Messing. Anwendung empfohlen mit nebenstehenden Abdeckrosetten CSL648 und CSL403.

ENGLISH : Chased glass clip polished and lacquered with support in steel.

GC8250L : Support in brass. Recommended use with opposite base collars CSL648 and CSL403.

NEDERLANDS : Decoratieve glasklem, gepolijst en gelakt met ondersteuning in staal.

GC8250L : Ondersteuning in messing. Toepassing wordt aanbevolen door de hiernaast vermelde afdekrosetten CSL648 en CSL403.

ESPAÑOL : Pinza de fijación cincelada pulida y barnizada con extremo de hierro.

GC8250L : contera de latón. Utilización aconsejada con el embellecedor de al lado: CSL648 o CSL403.

RUSSE : Стеклодержатель из латуни с креплением. Рекомендуется использовать вместе с основаниями CSL 648 и CSL 403.

FRANÇAIS : Pince de fixation en laiton avec support. Utilisation conseillée avec les cache-scelllements ci contre CSL 648 et CSL 403.

DEUTSCH : Messing Glashalter mit Stütze. Anwendung empfohlen mit nebenstehenden Abdeckrosetten CSL648 und CSL403.

ENGLISH : Brass glass clip with support. Recommended use with opposite base collars CSL648 and CSL403.

NEDERLANDS : Messing glasklem met ondersteuning. Toepassing wordt aanbevolen door de hiernaast vermelde afdekrosetten CSL648 en CSL403.

ESPAÑOL : Pinza de fijación de latón con soporte. Utilización aconsejada con el embellecedor de al lado: CSL648 o CSL403.

RUSSE : Стеклодержатель из латуни с креплением. Рекомендуется использовать вместе с основаниями CSL 648 и CSL 403.

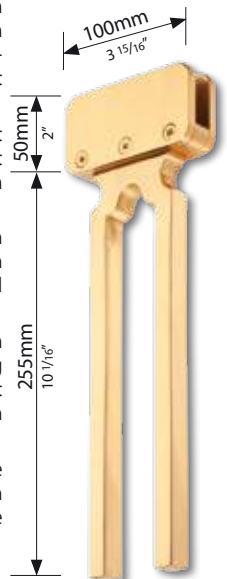

Embout Laiton
Stütze aus Messing
Brass Support
Ondersteuning in messing
Contera de latón
Латунное окончание

GC 1050 L*

Ep. Max 12mm



Embout Fer
Stütze aus Stahl
Steel Support
Ondersteuning in staal
Contera de hierro
Стальное окончание

GC 1050*

Exemple d'utilisation - Anwendungsbeispiel
Illustration - Voorbeelden voor toepassingen
Ejemplo de empleo - Пример использования



FRANÇAIS : Pince de fixation décorée polie vernie.

DEUTSCH : Ziselierter Glasshalter poliert und lackiert.

ENGLISH : Chased glass clip polished and lacquered.

NEDERLANDS : Decoratieve glasklem, gepolijst en gelakt.

ESPAÑOL : Pinza de latón pulida y barnizada.

RUSSE : Стеклодержатель полированный и покрытый лаком.

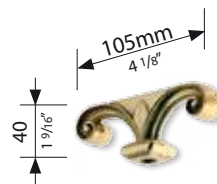

GC 8450*

FRANÇAIS : Pince de fixation décorée en laiton avec embase décorative.

GC8550 : embout fer.

DEUTSCH : Ziselierter Messing Glashalter mit Zierstütze.

GC8550 : Stütze aus Stahl.

ENGLISH : Chased brass glass clip with decorative support.

GC8550 : Steel support.

NEDERLANDS : Decoratieve glasklem met sier ondersteuning.

GC8550 : Ondersteuning in staal.

ESPAÑOL : Pinza de fijación cincelada en latón con base decorativa.

GC8550 : Contera de hierro

RUSSE : Латунный стеклодержатель с декоративным основанием.

GC8550 : Steel support.

GC8550 : Steel support.

GC8550 : Steel support.

GC8550 : Steel support.

GC8550 : Steel support.

GC8550 : Steel support.

GC8550 : Steel support.

GC8550 : Steel support.

GC8550 : Steel support.

GC8550 : Steel support.

GC8550 : Steel support.

GC8550 : Steel support.

GC8550 : Steel support.

GC8550 : Steel support.

GC8550 : Steel support.

GC8550 : Steel support.

GC8550 : Steel support.

FRANÇAIS : Pince de fixation décorée en laiton avec embase décorative.

GC8550 : embout fer.

DEUTSCH : Ziselierter Messing Glashalter mit Zierstütze.

GC8550 : Stütze aus Stahl.

ENGLISH : Chased brass glass clip with decorative support.

GC8550 : Steel support.

NEDERLANDS : Decoratieve glasklem met sier ondersteuning.

GC8550 : Ondersteuning in staal.

ESPAÑOL : Pinza de fijación cincelada en latón con base decorativa.

GC8550 : Contera de hierro

RUSSE : Латунный стеклодержатель с декоративным основанием.

GC8550 : Steel support.

GC8550 : Steel support.

GC8550 : Steel support.

GC8550 : Steel support.

GC8550 : Steel support.

GC8550 : Steel support.

GC8550 : Steel support.

GC8550 : Steel support.

GC8550 : Steel support.

GC8550 : Steel support.

GC8550 : Steel support.

GC8550 : Steel support.

GC8550 : Steel support.

GC8550 : Steel support.

GC8550 : Steel support.

GC8550 : Steel support.

GC8550 : Steel support.

FRANÇAIS : Pince de fixation décorée en laiton avec embase décorative.

GC8550 : embout fer.

DEUTSCH : Ziselierter Messing Glashalter mit Zierstütze.

GC8550 : Stütze aus Stahl.

ENGLISH : Chased brass glass clip with decorative support.

GC8550 : Steel support.

NEDERLANDS : Decoratieve glasklem met sier ondersteuning.

GC8550 : Ondersteuning in staal.

ESPAÑOL : Pinza de fijación cincelada en latón con base decorativa.

GC8550 : Contera de hierro

RUSSE : Латунный стеклодержатель с декоративным основанием.

GC8550 : Steel support.

GC8550 : Steel support.

GC8550 : Steel support.

GC8550 : Steel support.

GC8550 : Steel support.

GC8550 : Steel support.

GC8550 : Steel support.

GC8550 : Steel support.

GC8550 : Steel support.

GC8550 : Steel support.

GC8550 : Steel support.

GC8550 : Steel support.

GC8550 : Steel support.

GC8550 : Steel support.

GC8550 : Steel support.

GC8550 : Steel support.

GC8550 : Steel support.

FRANÇAIS : Pince de fixation décorée en laiton avec embase décorative.

GC8550 : embout fer.

DEUTSCH : Ziselierter Messing Glashalter mit Zierstütze.

GC8550 : Stütze aus Stahl.

ENGLISH : Chased brass glass clip with decorative support.

GC8550 : Steel support.

NEDERLANDS : Decoratieve glasklem met sier ondersteuning.

GC8550 : Ondersteuning in staal.

ESPAÑOL : Pinza de fijación cincelada en latón con base decorativa.

GC8550 : Contera de hierro

RUSSE : Латунный стеклодержатель с декоративным основанием.

GC8550 : Steel support.

GC8550 : Steel support.

GC8550 : Steel support.

GC8550 : Steel support.

GC8550 : Steel support.

GC8550 : Steel support.

GC8550 : Steel support.

GC8550 : Steel support.

GC8550 : Steel support.

GC8550 : Steel support.

GC8550 : Steel support.

GC8550 : Steel support.

GC8550 : Steel support.

GC8550 : Steel support.

GC8550 : Steel support.

GC8550 : Steel support.

GC8550 : Steel support.

FRANÇAIS : Pince de fixation décorée en laiton avec embase décorative.

GC8550 : embout fer.

DEUTSCH : Ziselierter Messing Glashalter mit Zierstütze.

GC8550 : Stütze aus Stahl.

ENGLISH : Chased brass glass clip with decorative support.

GC8550 : Steel support.

NEDERLANDS : Decoratieve glasklem met sier ondersteuning.

GC8550 : Ondersteuning in staal.

ESPAÑOL : Pinza de fijación cincelada en latón con base decorativa.

GC8550 : Contera de hierro

RUSSE : Латунный стеклодержатель с декоративным основанием.

GC8550 : Steel support.

GC8550 : Steel support.

GC8550 : Steel support.

GC8550 : Steel support.

GC8550 : Steel support.

GC8550 : Steel support.

GC8550 : Steel support.

GC8550 : Steel support.

GC8550 : Steel support.

GC8550 : Steel support.

GC8550 : Steel support.

GC8550 : Steel support.

GC8550 : Steel support.

GC8550 : Steel support.

GC8550 : Steel support.

GC8550 : Steel support.

GC8550 : Steel support.

FRANÇAIS : Pince de fixation décorée en laiton avec embase décorative.

GC8550 : embout fer.

DEUTSCH : Ziselierter Messing Glashalter mit Zierstütze.

GC8550 : Stütze aus Stahl.

ENGLISH : Chased brass glass clip with decorative support.

GC8550 : Steel support.

NEDERLANDS : Decoratieve glasklem met sier ondersteuning.

GC8550 : Ondersteuning in staal.

ESPAÑOL : Pinza de fijación cincelada en latón con base decorativa.

GC8550 : Contera de hierro

RUSSE : Латунный стеклодержатель с декоративным основанием.

GC8550 : Steel support.

GC8550 : Steel support.

GC8550 : Steel support.

GC8550 : Steel support.

GC8550 : Steel support.

GC8550 : Steel support.

GC8550 : Steel support.

GC8550 : Steel support.

GC8550 : Steel support.

GC8550 : Steel support.

GC8550 : Steel support.

GC8550 : Steel support.

GC8550 : Steel support.

GC8550 : Steel support.

GC8550 : Steel support.

GC8550 : Steel support.

GC8550 : Steel support.

FRANÇAIS : Pince de fixation décorée en laiton avec embase décorative.

GC8550 : embout fer.

DEUTSCH : Ziselierter Messing Glashalter mit Zierstütze.

GC8550 : Stütze aus Stahl.

ENGLISH : Chased brass glass clip with decorative support.

GC8550 : Steel support.

NEDERLANDS : Decoratieve glasklem met sier ondersteuning.

GC8550 : Ondersteuning in staal.

ESPAÑOL : Pinza de fijación cincelada en latón con base decorativa.

GC8550 : Contera de hierro

RUSSE : Латунный стеклодержатель с декоративным основанием.

GC8550 : Steel support.

GC8550 : Steel support.

GC8550 : Steel support.

GC8550 : Steel support.

GC8550 : Steel support.

GC8550 : Steel support.

GC8550 : Steel support.

GC85



FRANÇAIS : Ecrous décoratifs M 10. Produits conçus exclusivement pour l'intérieur.

DEUTSCH : Zierstück mit Gewinde M 10. Wir empfehlen diese Teile nur für den Innenbereich zu verwenden.

ENGLISH : Decorative fastener M 10. Items for indoor use only.

ESPAÑOL : Tornillo decorativo M 10. Productos exclusivamente para el interior.

RUSSE : Основан

FRANÇAIS : Equerre en laiton, voir schéma SUP6 page 109.

DEUTSCH : Messing Winkel, Siehe Plan SUP6, Seite 109.

ENGLISH : Brass angle bracket, see plan SUP6, page 109.

NEDERLANDS : Messing houder, zie schets SUP6, pagina 109.

ESPAÑOL : Escuadra en latón, ver esquema SUP6 pagina 109.

RUSSE : Боковое крепление из латуни, смотреть схему монтажа SUP6 на стр 109

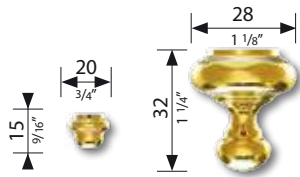

VL 2*

VL 3*



Patiné - Patinated
Patinado

SPL 6*

SPL 6P

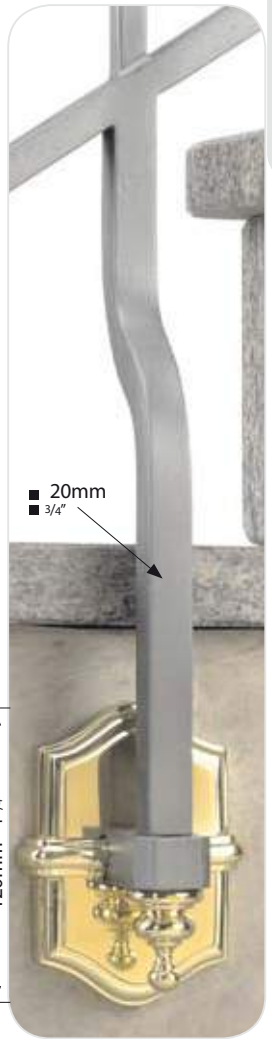
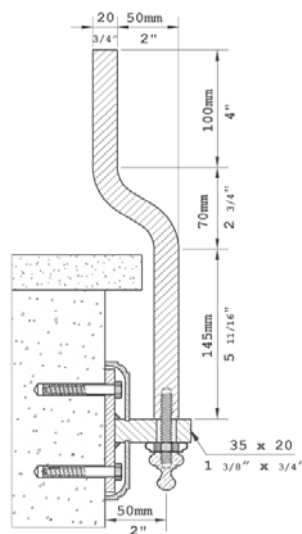

SPL 33*

FRANÇAIS : Pour fixer les balustres latéralement sur le limon : support en fer à trous ovales et pièce de recouvrement en laiton. Produits conçus exclusivement pour l'intérieur.

DEUTSCH : Zum seitlichen Aufschrauben der Stäbe auf die Wange : Träger aus Eisen mit ovalen Bohrungen und Messing Abdeckteile. Wir empfehlen diese Teile nur für den Innenbereich zu verwenden.

ENGLISH : To fix balusters on the side of the stringer : Steel bracket with oval holes and brass parts. Items for indoor use only.

ESPAÑOL : Para fijar los balaustres lateralmente en la zanca. Soporte de hierro con agujeros ovales y pieza de embellecedor de latón. Productos exclusivamente para el interior.

RUSSE : Для крепления балясин на косоуре: боковое крепление из стали в комплекте с декоративной пластиной из латуни. Для использования только внутри помещения.

FRANÇAIS : Support de lisse composé d'une platine en fer ép. 8 mm avec trous ovales et d'un montant en fer carré. Les pièces de recouvrement ainsi que la vis sont en laiton. Produits conçus exclusivement pour l'intérieur.

DEUTSCH : Geländer-Untergurtstütze bestehend aus einem 8 mm dicken Eisenflansch mit ovalen Bohrungen und einem Träger aus Vierkanteisen. Die Abdeckstücke und Schraube sind aus Messing. Wir empfehlen diese Teile nur für den Innenbereich zu verwenden.

ENGLISH : Bottom rail bracket consists of an 8 mm thick steel plate and a support arm formed from square steel bar. The covering pieces are made from brass. Items for indoor use only.

NEDERLANDS : Stalen leuning- en balustrade-ondersteuning, bestaande uit een ijzeren plaat van 8 mm dik met ovale gaten en een vierkant ijzeren drager und messing zichtdelen. Gebruik : uitsluitend voor interieurs.

ESPAÑOL : Soporte para pletina compuesto por una plancha de hierro de 8 mm con agujeros ovales y por un montante en cuadrado de 20 mm. El embellecedor así como el tornillo, son de latón. Productos exclusivamente para el interior.

RUSSE : Нижнее боковое крепление состоящее из 8мм стальной пластины с овальными отверстиями и квадратного стального поддерживающего стержня. Для использования только внутри помещения.

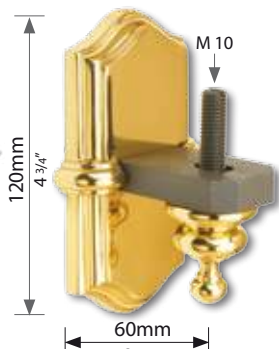
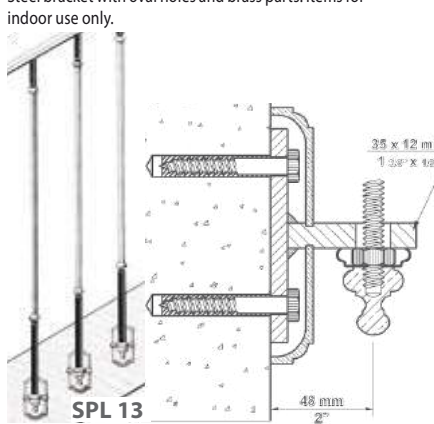

SPL 13*

FRANÇAIS : Boules pleines en laiton munies d'un taraudage. Produits conçus exclusivement pour l'intérieur.

DEUTSCH : Messing-Vollkugeln mit Innengewinde. Wir empfehlen diese Teile nur für den Innenbereich zu verwenden.

ENGLISH : Full bodied brass balls with a threaded hole. Items for indoor use only.

NEDERLANDS : Massieve messing bollen met draadgat. Gebruik : uitsluitend voor interieurs.

ESPAÑOL : Bolas macizas en latón con un taladro roscado. Productos exclusivamente para el interior.

RUSSE : Цельные латунные шары с резьбовым отверстием. Для использования в помещении.

BOULES MASSIVES
VOLLKUGELN
SOLID BALLS
MASSIEVE BOLLEN
BOLAS MACIZAS
ЦЕЛЬНЫЕ ШАРЫ



Verni - Lacquered - Lackiert - Barnizado - Покрты лаком

| | | |
|---------------------|------|--------|
| D: 15 mm 9/16" | M 6 | KL 15* |
| D: 20 mm 3/4" | M 6 | KL 20* |
| D: 25 mm 1" | M 6 | KL 25* |
| D: 30 mm 1 3/16" | M 8 | KL 30* |
| D: 40 mm 1 9/16" | M 10 | KL 40* |

FRANÇAIS : Boules creuses en laiton munies d'un taraudage. Produits conçus exclusivement pour l'intérieur. **KL100G-KL130G: Boules creuses en acier inoxydable 304 munies d'un taraudage.

DEUTSCH : Messing-Hohlkugeln mit Innengewinde. Wir empfehlen diese Teile nur für den Innenbereich zu verwenden. **KL100G-KL130G: V2A-Hohlkugeln mit Innengewinde.

ENGLISH : Hollow brass balls with a threaded hole. Items for indoor use only. **KL100G-KL130G: Hollow stainless steel type 304 balls with a threaded hole.

NEDERLANDS : Holle messing bollen met draadgat. Gebruik : uitsluitend voor interieurs. **KL100G-KL130G: Holle type 304 RVS (stainless steel) bollen met draadgat.

ESPAÑOL : Bolas huecas en latón con un taladro roscado. Productos exclusivamente para el interior. **KL100G-KL130G: Bolas huecas en acero 304 con un taladro roscado.

RUSSE : Пустотелые латунные шары с резьбовым отверстием. Для использования в помещении. Полые шары из нержавеющей стали (марка 304) с нарезанной внутренней резьбой

BOULES CREUSES
HOHLKUGELN
HOLLOW BALLS
HOLLE BOLEN
BOLAS HUECAS
ПОЛЫЕ ШАРЫ



Verni - Lacquered - Lackiert - Barnizado - Покрты лаком

| | | |
|-----------------------|------|----------|
| D: 50 mm 2" | M 10 | KL 50* |
| D: 75 mm 3" | M 10 | KL 75* |
| D: 100 mm 3 15/16" | M 12 | KL 100** |
| D: 130 mm 5 1/8" | M 12 | KL 130** |

MAINS COURANTES - HANDLÄUFE - HANDRAILS

Nous consulter - Um uns zu konsultieren
Consult us - Om ons te raadplegen - Consultarnos
Чтобы проконсультироваться с нами

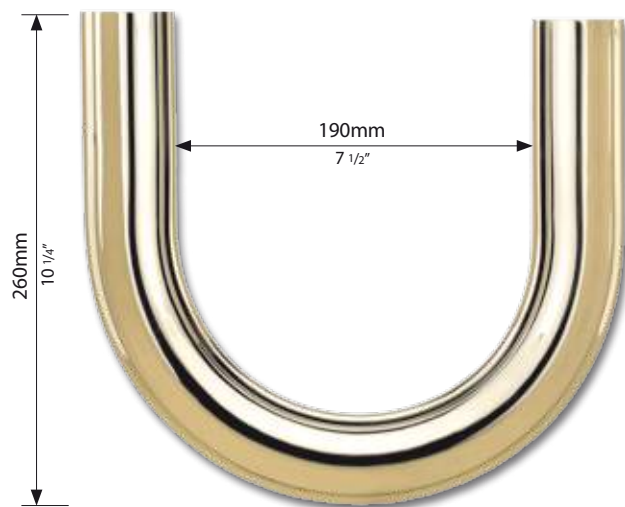
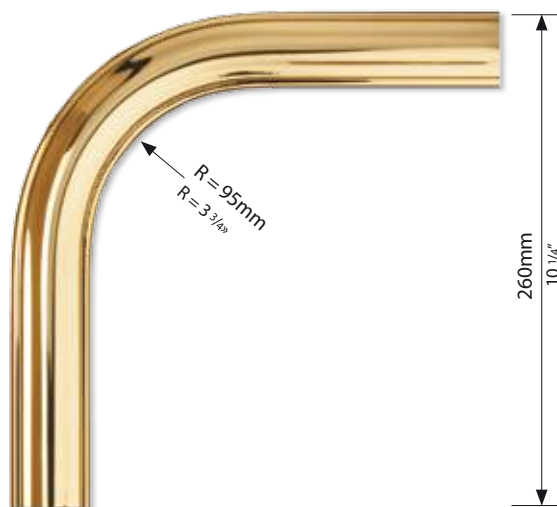
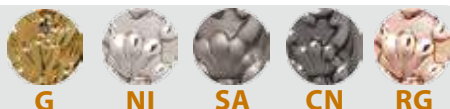

| | | |
|---------------------|----------------|-----------------|
| POUR/FÜR/FOR MCL 45 | COL 45* | COL 45 P |
| POUR/FÜR/FOR MCL 50 | COL 50* | COL 50 P |
| POUR/FÜR/FOR MCL 60 | - | COL 60 P |

| | | |
|---------------------|----------------|-----------------|
| POUR/FÜR/FOR MCL 45 | CUL 45* | CUL 45 P |
| POUR/FÜR/FOR MCL 50 | CUL 50* | CUL 50 P |
| POUR/FÜR/FOR MCL 60 | - | CUL 60 P |

FRANÇAIS : Main courante en laiton spécial Cu Zn 40 MnA facilitant le cintrage à chaud. Livrable brut de laminage ou prépoli : "P" (Un polissage de finition est à prévoir). Sous-lisse recommandée : plat 20 x 12 mm.

DEUTSCH : Handlauf aus Cu Zn 40 MnA- Sondermessing, der das Warmbiegen erleichtert. Lieferbar roh oder vorpoliert : "P" (Eine Endpolierung ist vorzusehen). Empfohlener Untergurt : 20 x 12 mm.

ENGLISH : Special brass handrails (Cu Zn 40 MnA) making hot bending easier, available rough-laminated or, prepolished : "P" (Denotes polished finish). Recommended flat bar : 20 x 12 mm (3/4 x 1/2").

NEDERLANDS : Handgreep uit smeedbaar messing, (Cu Zn 40 MnA) voor warm te buigen. Leverbaar in niet gepolijste en gepolijste uitvoering : "P". Met een sponning voor plat 20 x 12 mm.

ESPAÑOL : Pasamanos en latón especial, Cu Zn 40 MnA., para facilitar el curvado en caliente. Se suministran en bruto de laminación ó prepolidos : "P". Debe preverse un pulido de acabado. Dimensiones de la pletina de base recomendadas : 20 x 12 mm.

RUSSE : Перила из специальной латуни (Cu Zn 40 MnA), которая легко поддаётся горячей гибке. Могут быть с необработанной или полированной поверхностью : "P" означает полировку. Для монтажа рекомендуется использовать полосу : 20 x 12 мм.

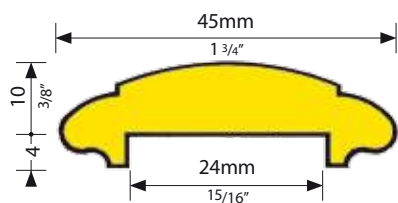

L 3 m - 9,84 ft **MCL 45***
L 3 m - 9,84 ft **MCL 45 P**

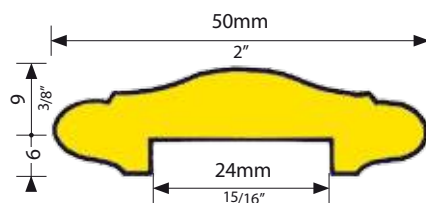

L 3 m - 9,84 ft **MCL 50***
L 3 m - 9,84 ft **MCL 50 P**

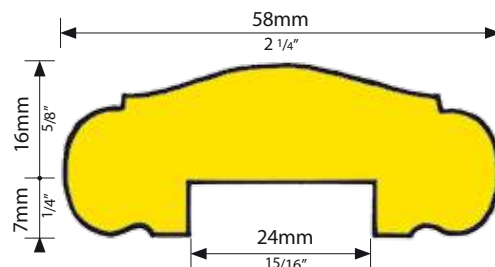

L 3 m - 9,84 ft **MCL 60***
L 3 m - 9,84 ft **MCL 60 P**

FRANÇAIS : Départ en laiton poli, prévu pour sous-lisse en plat de 20 x 12 mm.

DEUTSCH : Endstück aus Messing, poliert. Vorgesehen für Untergurt 20 x 12 mm.

ENGLISH : Brass volute-end, polished. Recessed to receive a 20 x 12 mm bar (3/4 x 1/2").

NEDERLANDS : Massief eindstuk. Met sponning voor onderstrip 20 x 12 mm.

ESPAÑOL : Arranque de pasamanos en latón pulido previstas para pletina de base de 20 x 12 mm.

RUSSE : Латунный завиток, полированный. Имеет углубление для полосы 20 x 12 мм.

FRANÇAIS : Bague couvre-joint en laiton poli.

DEUTSCH : Fugenabdeckbund aus Messing poliert.

ENGLISH : Polished brass coverjoint collar.

NEDERLANDS : Messing koppelstuk voor handgreep, gepolijst.

ESPAÑOL : Abrazadera tapajuntas en latón pulido.

RUSSE : Латунный стыковочный элемент.



| | | | |
|---------------------|----------------|-----------------|----------------|
| POUR/FÜR/FOR MCL 45 | DRL 45* | DRLC 45* | RAL 45* |
| POUR/FÜR/FOR MCL 50 | DRL 50* | DRLC 50* | RAL 50* |
| POUR/FÜR/FOR MCL 60 | DRL 60* | DRLC 60* | RAL 60* |

HANDGREPEN - PASAMANOS - ПЕРИЛА

FRANÇAIS : Départs de rampe "LATERAL" pour MCL 45, MCL 50 et MCL 60 en laiton. Ils sont polis, mais un polissage de finition est à prévoir. Ils sont fournis avec une sous-lisse en fer plat de 20 x 12 mm.

DEUTSCH : "LATERAL"-Anfangsstücke für MCL 45, MCL 50 und MCL 60 aus Messing vorpoliert. Eine Endpolierung ist vorzusehen. Geliefert mit einem Untergurt aus 20x12mm Flacheisen.

ENGLISH : "LATERAL" scrolls for MCL 45, MCL 50 and MCL 60 are supplied in solid polished brass with a steel scroll 20x12mm, 3/4 x 1/2".

NEDERLANDS : "LATERAL" gepolijst messing eindstukken voor MCL 45, MCL 50 MCL 60. Met sponning voor onderstrip 20x12 mm.

ESPAÑOL : Arranque de barandilla "LATERAL" para MCL 45, MCL 50 y MCL 60 en latón. Aunque el acabado es prepulido, debe preverse un pulido de terminación. Adaptables a una pletina de acero de 20 x 12 mm.

RUSSE : «БОКОВЫЕ» завитки поручня для MCL 50, MCL 45, MCL 60 изготовлены из массива латуни и поставляются в комплекте со стальным завитком 20 x 12 мм.



| | | |
|-----------------|---------------------|-----------------|
| DL 45 L* | POUR/FÜR/FOR MCL 45 | DL 45 R* |
| DL 50 L* | POUR/FÜR/FOR MCL 50 | DL 50 R* |
| DL 60 L* | POUR/FÜR/FOR MCL 60 | DL 60 R* |

FRANÇAIS : Socles de raccordement en laiton poli et verni ou doré à l'or fin 24 carats "G". Produits conçus exclusivement pour l'intérieur.

DEUTSCH : Pfostenabschluß aus Messing, poliert und lackiert oder mit 24 Karat Feingold überzogen "G". Wir empfehlen diese Teile nur für den Innenbereich zu verwenden.

ENGLISH : Brass finial bases, polished and lacquered or 24-carat gold plated "G". Items for indoor use only.

NEDERLANDS : Messing baluster aansluitsockels, gepolijst en gelakt of 24 karaats verguld "G". Gebruik: uitsluitend voor interieurs.

ESPAÑOL : Zócalos de pedestal en latón pulido y barnizado ó dorados con oro fino de 24 quilates "G". Productos exclusivamente para el interior.

RUSSE : Латунные основания могут быть полированные и лакированные, либо позолоченные 24 карата "G". Для использования только в помещении.

FRANÇAIS : Lisse inférieure "LATERAL" en fer plat 20 x 12 mm. Utilisable à gauche ou à droite. **POUR DL 45/50/60 L&R.**

DEUTSCH : "LATERAL"-Untergurt aus 20x12mm Flacheisen. Links und Rechts verwendbar. **FÜR DL 45/50/60 L&R.**

ENGLISH : "LATERAL" bottom rail scroll made of a 20 x 12 mm (3/4 x 1/2") steel bar. Fit for use left or right. **FOR DL 45/50/60 L&R.**

NEDERLANDS : "LATERAL" ijzeren onderstrip 20x12 mm. Zowel links als rechts bruikbaar. **VOOR DL 45/50/60 L&R.**

ESPAÑOL : Pletina inferior "LATERAL" en acero de 20 x 12 mm. Utilizable a izquierda y derecha. **PARA DL 45/50/60 L&R.**

RUSSE : «БОКОВОЙ» нижний завиток для перил выполнен из стальной полосы 20 x 12 мм. Может устанавливаться как слева, так и справа. **ДЛЯ DL 45/50/60 L&R.**

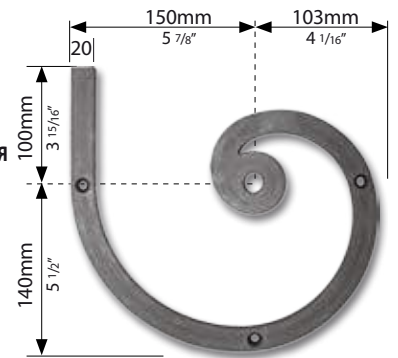

20 x 12 mm
3/4 x 1/2" **DL 51**

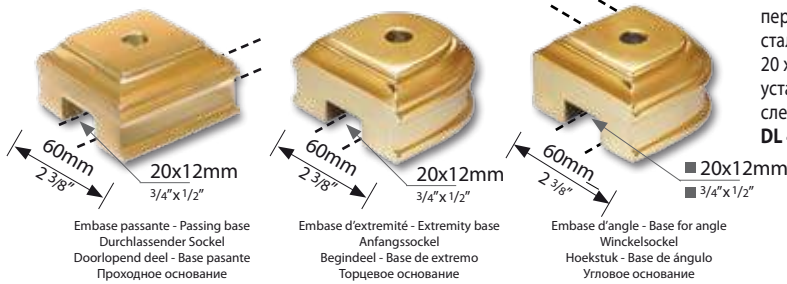

TSL 1* **TSL 2*** **TSL 3***

FRANÇAIS : Supports - cavaliers de main courante en fer brut à souder à la sous-lisse. Produits conçus exclusivement pour l'intérieur.

DEUTSCH : Handlaufträger aus Eisen zum Anschweißen. Wir empfehlen diese Teile nur für den Innenbereich zu verwenden.

ENGLISH : Handrail brackets made of steel, to weld on. Items for indoor use only.

NEDERLANDS : Stalen muurleuningdragers, lasbaar. Gebruik: uitsluitend voor interieurs.

ESPAÑOL : Soporte para pasamanos en hierro para soldar a la pletina base. Productos exclusivamente para el interior.

RUSSE : Боковой стальной держатель поручня с латунным основанием. Для использования только в помещении.

FRANÇAIS : Set de nettoyage pour éléments de mains courantes laiton comprenant de la cire, du lustrant et de la paille de fer.

DEUTSCH : Pflege-Set für Handlaufteile aus Messing mit Wachs, Glanzreiniger und Stahlwolle.

ENGLISH : Care-kit for handrail parts in brass, including wax, polish and steel wool.

NEDERLANDS : Onderhoudskit voor messing leuning onderdelen, bestaande uit wax, glansmiddel en staalwol.

ESPAÑOL : Kit de limpieza para elementos de pasamanos de latón compuesto por: cera, lustrador y lana de hierro.

RUSSE : Набор для ухода за латунными элементами перил, в состав которого входит воск, полироль и ткань с металлическими волокнами.

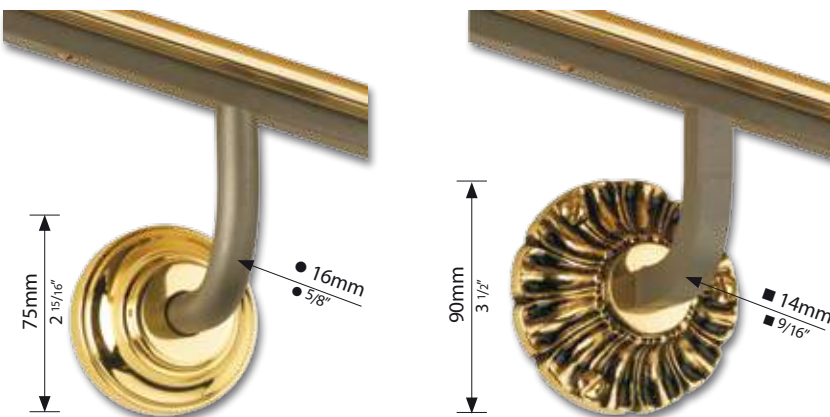

SML 31*



SML 32*



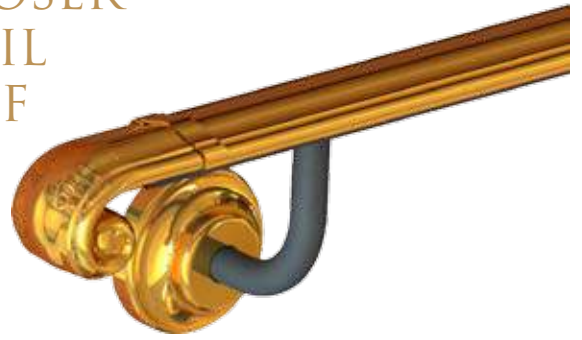

MCL-SET

MAINS COURANTES PRÊTES A POSER READY-TO-INSTALL HANDRAIL EINBAUFERTIGER HANDLAUF



| Longueur | 1000 mm 39 3/8" | 1500 mm 58 5/8" | 2000 mm 78" | 3000 mm 10 ft. |
|--|--------------------|--------------------|----------------|-------------------|
|  <p>45mm 1 3/4"</p> | MC-L1-45-1000 | MC-L1-45-1500 | MC-L1-45-2000 | MC-L1-45-3000 |
|  <p>50mm 2"</p> | MC-L1-50-1000 | MC-L1-50-1500 | MC-L1-50-2000 | MC-L1-50-3000 |
|  <p>58mm 2 1/4"</p> | MC-L1-60-1000 | MC-L1-60-1500 | MC-L1-60-2000 | MC-L1-60-3000 |

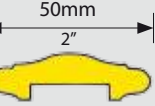

| Longueur | 1000 mm 39 3/8" | 1500 mm 58 5/8" | 2000 mm 78" | 3000 mm 10 ft. |
|--|--------------------|--------------------|----------------|-------------------|
|  <p>45mm 1 3/4"</p> | MC-L2-45-1000 | MC-L2-45-1500 | MC-L2-45-2000 | MC-L2-45-3000 |
|  <p>50mm 2"</p> | MC-L2-50-1000 | MC-L2-50-1500 | MC-L2-50-2000 | MC-L2-50-3000 |
|  <p>58mm 2 1/4"</p> | MC-L2-60-1000 | MC-L2-60-1500 | MC-L2-60-2000 | MC-L2-60-3000 |



LEUNINGEN KLAAR OM OP TE HANGEN
 BARANDILLA LISTA PARA INSTALAR
 ПЕРИЛА ГОТОВЫ К УСТАНОВКЕ

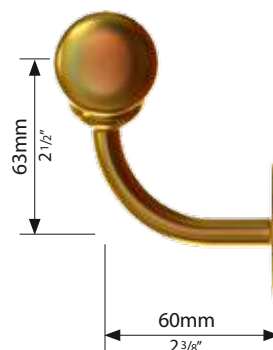
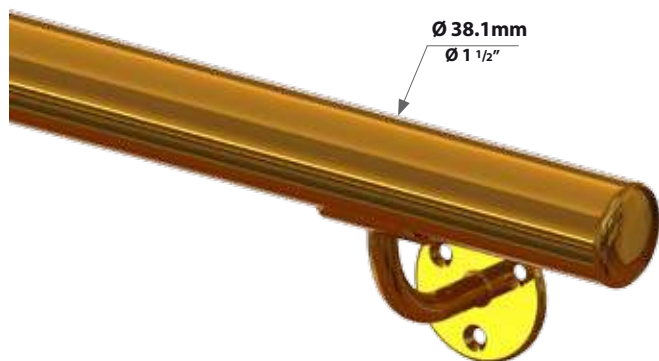
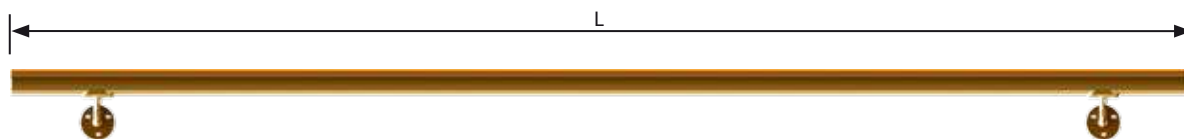

Longueur 1000 mm
 Lengths 39 3/8"

MC-NY1-1000



Longueur 1500 mm
 Lengths 58 5/8"

MC-NY1-1500



Longueur 2000 mm
 Lengths 78"

MC-NY1-2000



Longueur 3000 mm
 Lengths 10 ft.

MC-NY1-3000

FRANÇAIS : Set de nettoyage pour éléments de mains courantes laiton comprenant de la cire, du lustrant et de la paille de fer.

DEUTSCH : Pflege-Set für Handlaufteile aus Messing mit Wachs, Glanzreiniger und Stahlwolle.

ENGLISH : Care-kit for handrail parts in brass, including wax, polish and steel wool.

NEDERLANDS : Onderhoudskit voor messing leuning onderdelen, bestaande uit wax, glansmiddel en staalwol.

ESPAÑOL : Kit de limpieza para elementos de pasamanos de latón compuesto por: cera, lustrador y lana de hierro.

RUSSE : Набор для ухода за латунными элементами перил, в состав которого входит воск, полироль и ткань с металлическими волокнами.



MCL-SET

TETES DE DEPART - ZIERAUFsätze - FINIALS ОКОНЧАНИЯ СТОЛБОВ



EINDAFWERKING HANDGREEP - CABEZALES



TBL 38



TBL 53-GO



TCARB-G



TBL90-BLU

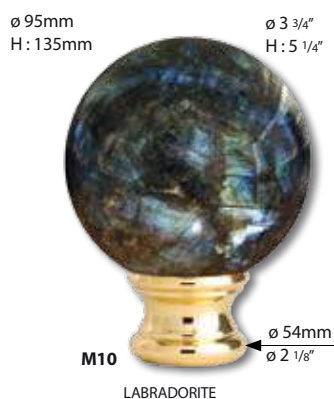

TBL 53-LA



TBL 60



TBL 57

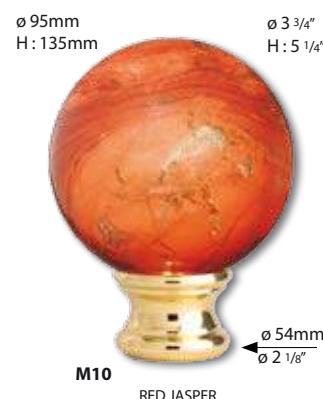

TBL 56



TBL 54



TBL 53

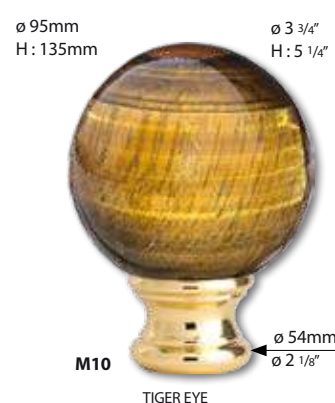

TBL 53-TE



TBL 70

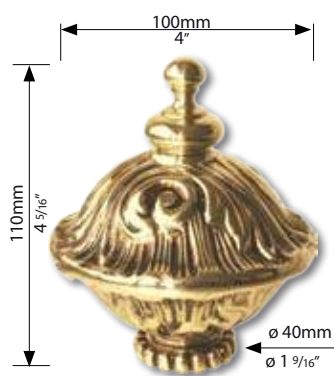

TBL 5*



TBL 9*



TB300L



TB300NI

CACHE-SCELLEMENTS - BASE COLLARS - ABDECKROSETTEN AFDEKROZETTEN ROSETA-EMBELLEDOR - ОСНОВАНИЯ

FRANÇAIS : Cache-scellements en laiton. Produits conçus exclusivement pour l'intérieur.

DEUTSCH : Messing Abdeckrosetten. Wir empfehlen diese Teile nur für den Innenbereich zu verwenden.

ENGLISH : Brass base collars. Items for indoor use only.

NEDERLANDS : Messing afdekrozetten. Gebruik : uitsluitend voor interieurs.

ESPAÑOL : Roseta-embellecedor en latón. Productos exclusivamente para el interior.

RUSSE : Латунные основания.
Для использования только в помещении.

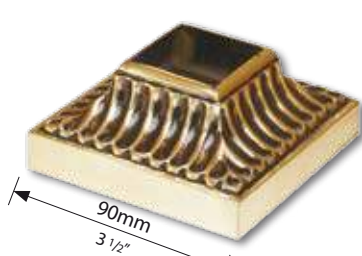

■ 35 mm
1 3/8" **CSL 140***

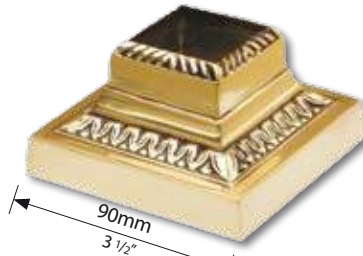

■ 35 mm
1 3/8" **CSL 940***

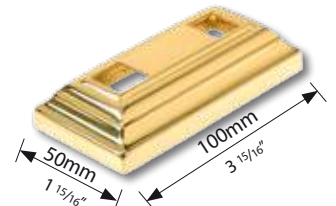

■ 14 x 16 mm
9/16 x 5/8" **CSL 648***

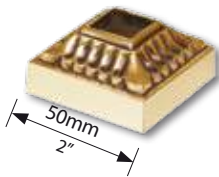

■ 16 mm
5/8" **CSL 147***

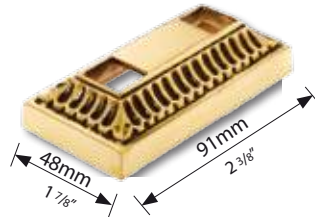

■ 14 x 16 mm
9/16 x 5/8" **CSL 403***

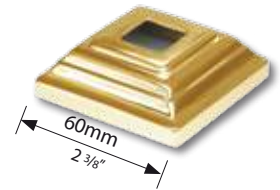

■ 14 mm
9/16" **CSL 614***
■ 16 mm
5/8" **CSL 616***
■ 20 mm
3/4" **CSL 620***

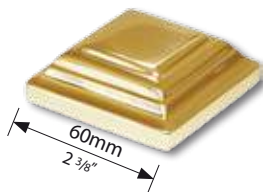

CSL 600*

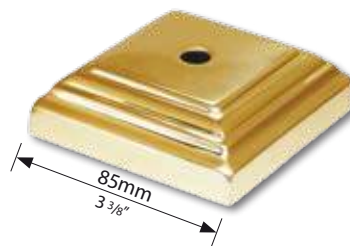

● 10 mm
3/8" **CSL 810***

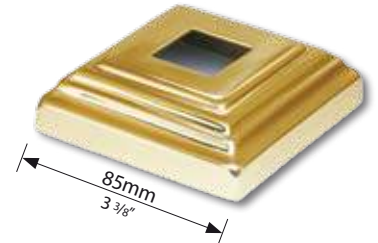

■ 25 mm
1" **CSL 825***
■ 35 mm
1 3/8" **CSL 835***

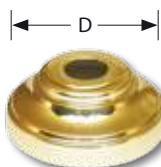

D

| | | |
|-------------------|------------------|----------------|
| ● 10 mm 3/8" | 53 mm 2 1/16" | CSL 50* |
| ● 14 mm 9/16" | 53 mm 2 1/16" | CSL 51* |
| ● 16 mm 5/8" | 63 mm 2 1/2" | CSL 61* |
| ● 18 mm 11/16" | 75 mm 3" | CSL 78* |

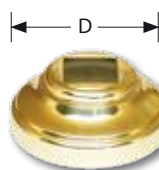

D

| | | |
|------------------|------------------|----------------|
| ■ 14 mm 9/16" | 53 mm 2 1/16" | CSL 52* |
| ■ 16 mm 5/8" | 53 mm 2 1/16" | CSL 54* |
| ■ 20 mm 3/4" | 53 mm 2 1/16" | CSL 53* |
| ■ 20 mm 3/4" | 63 mm 2 1/2" | CSL 63* |



● 30 mm
1 3/16" **CSL 113***
● 40 mm
1 9/16" **CSL 114***

| | | | | | | | | | | | | | | | | | | | | | | | | | | | | | | | | | | | | | | | | | | | |
|---|---|--|---|----------|----------|---------|---|---------|----------|----------|----------|-----------|--|---|---------|----------|---------|----------|--------|--|--------|--|---------|---------|---------|---------|--------|--|--------|--|--|---------|----------|---------|----------|---------|----------|----------|--|-----------|--|-----------|--|
|  67mm 2 5/8" |  67mm 2 5/8" |  60 - 2 3/8" |  105mm - 4 1/8" | | | | | | | | | | | | | | | | | | | | | | | | | | | | | | | | | | | | | | | | |
| P : Patiné - Patinated | | P : Patiné - Patinated | | | | | | | | | | | | | | | | | | | | | | | | | | | | | | | | | | | | | | | | | |
| <table border="0"> <tr><td>● 10 mm</td><td>CSL 80 *</td></tr> <tr><td>● 10 mm</td><td>CSL 80 P</td></tr> <tr><td>● 3/8"</td><td></td></tr> </table> | ● 10 mm | CSL 80 * | ● 10 mm | CSL 80 P | ● 3/8" | | <table border="0"> <tr><td>■ 16 mm</td><td>CSL 86 *</td></tr> <tr><td>■ 16 mm</td><td>CSL 86 P</td></tr> <tr><td>■ 5/8"</td><td></td></tr> </table> | ■ 16 mm | CSL 86 * | ■ 16 mm | CSL 86 P | ■ 5/8" | | <table border="0"> <tr><td>● 10 mm</td><td>CSL 10 P</td></tr> <tr><td>● 16 mm</td><td>CSL 16 P</td></tr> <tr><td>● 3/8"</td><td></td></tr> <tr><td>● 5/8"</td><td></td></tr> <tr><td>● 10 mm</td><td>CSL 10*</td></tr> <tr><td>● 16 mm</td><td>CSL 16*</td></tr> <tr><td>● 3/8"</td><td></td></tr> <tr><td>● 5/8"</td><td></td></tr> </table> | ● 10 mm | CSL 10 P | ● 16 mm | CSL 16 P | ● 3/8" | | ● 5/8" | | ● 10 mm | CSL 10* | ● 16 mm | CSL 16* | ● 3/8" | | ● 5/8" | | <table border="0"> <tr><td>● 18 mm</td><td>CSL 18 *</td></tr> <tr><td>● 30 mm</td><td>CSL 30 *</td></tr> <tr><td>● 40 mm</td><td>CSL 40 *</td></tr> <tr><td>● 11/16"</td><td></td></tr> <tr><td>● 1 3/16"</td><td></td></tr> <tr><td>● 1 9/16"</td><td></td></tr> </table> | ● 18 mm | CSL 18 * | ● 30 mm | CSL 30 * | ● 40 mm | CSL 40 * | ● 11/16" | | ● 1 3/16" | | ● 1 9/16" | |
| ● 10 mm | CSL 80 * | | | | | | | | | | | | | | | | | | | | | | | | | | | | | | | | | | | | | | | | | | |
| ● 10 mm | CSL 80 P | | | | | | | | | | | | | | | | | | | | | | | | | | | | | | | | | | | | | | | | | | |
| ● 3/8" | | | | | | | | | | | | | | | | | | | | | | | | | | | | | | | | | | | | | | | | | | | |
| ■ 16 mm | CSL 86 * | | | | | | | | | | | | | | | | | | | | | | | | | | | | | | | | | | | | | | | | | | |
| ■ 16 mm | CSL 86 P | | | | | | | | | | | | | | | | | | | | | | | | | | | | | | | | | | | | | | | | | | |
| ■ 5/8" | | | | | | | | | | | | | | | | | | | | | | | | | | | | | | | | | | | | | | | | | | | |
| ● 10 mm | CSL 10 P | | | | | | | | | | | | | | | | | | | | | | | | | | | | | | | | | | | | | | | | | | |
| ● 16 mm | CSL 16 P | | | | | | | | | | | | | | | | | | | | | | | | | | | | | | | | | | | | | | | | | | |
| ● 3/8" | | | | | | | | | | | | | | | | | | | | | | | | | | | | | | | | | | | | | | | | | | | |
| ● 5/8" | | | | | | | | | | | | | | | | | | | | | | | | | | | | | | | | | | | | | | | | | | | |
| ● 10 mm | CSL 10* | | | | | | | | | | | | | | | | | | | | | | | | | | | | | | | | | | | | | | | | | | |
| ● 16 mm | CSL 16* | | | | | | | | | | | | | | | | | | | | | | | | | | | | | | | | | | | | | | | | | | |
| ● 3/8" | | | | | | | | | | | | | | | | | | | | | | | | | | | | | | | | | | | | | | | | | | | |
| ● 5/8" | | | | | | | | | | | | | | | | | | | | | | | | | | | | | | | | | | | | | | | | | | | |
| ● 18 mm | CSL 18 * | | | | | | | | | | | | | | | | | | | | | | | | | | | | | | | | | | | | | | | | | | |
| ● 30 mm | CSL 30 * | | | | | | | | | | | | | | | | | | | | | | | | | | | | | | | | | | | | | | | | | | |
| ● 40 mm | CSL 40 * | | | | | | | | | | | | | | | | | | | | | | | | | | | | | | | | | | | | | | | | | | |
| ● 11/16" | | | | | | | | | | | | | | | | | | | | | | | | | | | | | | | | | | | | | | | | | | | |
| ● 1 3/16" | | | | | | | | | | | | | | | | | | | | | | | | | | | | | | | | | | | | | | | | | | | |
| ● 1 9/16" | | | | | | | | | | | | | | | | | | | | | | | | | | | | | | | | | | | | | | | | | | | |
| | | P : Patiniert - Patinado | | | | | | | | | | | | | | | | | | | | | | | | | | | | | | | | | | | | | | | | | |
| | | <table border="0"> <tr><td>● 18 mm</td><td>CSL 18 P</td></tr> <tr><td>● 30 mm</td><td>CSL 30 P</td></tr> <tr><td>● 40 mm</td><td>CSL 40 P</td></tr> <tr><td>● 11/16"</td><td></td></tr> <tr><td>● 1 3/16"</td><td></td></tr> <tr><td>● 1 9/16"</td><td></td></tr> </table> | | ● 18 mm | CSL 18 P | ● 30 mm | CSL 30 P | ● 40 mm | CSL 40 P | ● 11/16" | | ● 1 3/16" | | ● 1 9/16" | | | | | | | | | | | | | | | | | | | | | | | | | | | | | |
| ● 18 mm | CSL 18 P | | | | | | | | | | | | | | | | | | | | | | | | | | | | | | | | | | | | | | | | | | |
| ● 30 mm | CSL 30 P | | | | | | | | | | | | | | | | | | | | | | | | | | | | | | | | | | | | | | | | | | |
| ● 40 mm | CSL 40 P | | | | | | | | | | | | | | | | | | | | | | | | | | | | | | | | | | | | | | | | | | |
| ● 11/16" | | | | | | | | | | | | | | | | | | | | | | | | | | | | | | | | | | | | | | | | | | | |
| ● 1 3/16" | | | | | | | | | | | | | | | | | | | | | | | | | | | | | | | | | | | | | | | | | | | |
| ● 1 9/16" | | | | | | | | | | | | | | | | | | | | | | | | | | | | | | | | | | | | | | | | | | | |

FRANÇAIS : Equerre de raccordement pour poteaux à extrémités carrées. En fer usiné, elle est à souder aux lisses basse et haute. Livrée avec une vis, six pans creux M 10.

DEUTSCH : Verbindungswinkel aus Eisen für Pfosten mit vierkant Endstücken. Zum anschweißen an die Ober- und Untergurte. Geliefert mit einer M 10 Senkkopfschraube mit Innen-sechskant, verdeckt.

ENGLISH : Right angle steel connector for square posts, designed to be welded to upper and lower rails. Supplied with M10 hex socket head screw.

NEDERLANDS : Ijzeren verbindingshoek om hoofdbalusters met leuningprofielen te verbinden d.m.v. lassen/schroeven. Geleverd met M10 schroef met inwendig zeskant.

ESPAÑOL : Escuadra para el empalme de balaustres de arranque con extremos cuadrados. En acero mecanizado, están listas para soldar a las pletinas inferior y superior. Se suministra con un tornillo ALLEN de M 10.

RUSSE : Стальной соединительный элемент для квадратных стоек, можно приваривать как к верху, так и к низу ограждения. В комплект поставки входит винт М10 с шестигранной головкой.

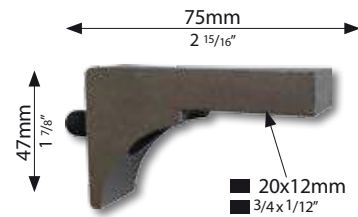

RAC 20

**ACIER INOXYDABLE REVÊTEMENT PVD
STAINLESS STEEL PVD COATED**

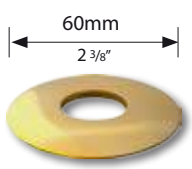
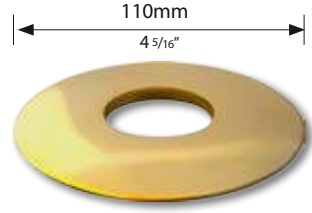
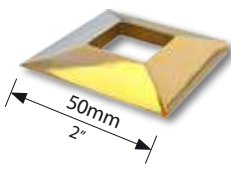
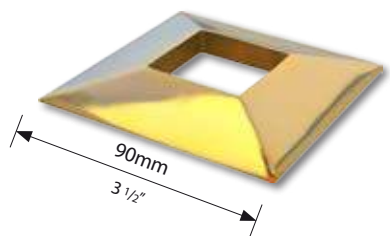

G = BL127G NI = BL127NI L = BL127L RO = BL127RO

| | | | | | | | | | | | | | | | | | | | |
|---|---|--|---|--|--|---------|---------|-----------|--|---|---------|---------|--------|--|---|---------|---------|----------|--|
|  60mm 2 3/8" |  110mm 4 5/16" |  50mm 2" |  90mm 3 1/2" | | | | | | | | | | | | | | | | |
| <table border="0"> <tr><td>● 16 mm</td><td>CSRF16L</td></tr> <tr><td>● 5/8"</td><td></td></tr> </table> | ● 16 mm | CSRF16L | ● 5/8" | | <table border="0"> <tr><td>● 40 mm</td><td>CSRF40L</td></tr> <tr><td>● 1 9/16"</td><td></td></tr> </table> | ● 40 mm | CSRF40L | ● 1 9/16" | | <table border="0"> <tr><td>■ 16 mm</td><td>CSKF16L</td></tr> <tr><td>■ 5/8"</td><td></td></tr> </table> | ■ 16 mm | CSKF16L | ■ 5/8" | | <table border="0"> <tr><td>■ 35 mm</td><td>CSKF35L</td></tr> <tr><td>■ 1 3/8"</td><td></td></tr> </table> | ■ 35 mm | CSKF35L | ■ 1 3/8" | |
| ● 16 mm | CSRF16L | | | | | | | | | | | | | | | | | | |
| ● 5/8" | | | | | | | | | | | | | | | | | | | |
| ● 40 mm | CSRF40L | | | | | | | | | | | | | | | | | | |
| ● 1 9/16" | | | | | | | | | | | | | | | | | | | |
| ■ 16 mm | CSKF16L | | | | | | | | | | | | | | | | | | |
| ■ 5/8" | | | | | | | | | | | | | | | | | | | |
| ■ 35 mm | CSKF35L | | | | | | | | | | | | | | | | | | |
| ■ 1 3/8" | | | | | | | | | | | | | | | | | | | |

NEW-YORK

FRANÇAIS : Un look qui nous vient des USA : ces raccords en laiton vous donnent de nouvelles possibilités architecturales. Ils sont conçus pour du tube de 38 ou 50,8 mm. De façon à réduire les travaux de polissage ultérieurs, ils sont prépolis, mais non vernis. Les assemblages sont à réaliser par soudobrasage ou vissage. Nous vous recommandons de vous assurer à ce que les normes de construction des garde-corps soient bien respectées.

DEUTSCH : Ein Look, der aus den USA kommt! Neue architektonische Möglichkeiten ! Diese Messingverbindungsstücke sind vorgesehen für 38 mm oder 50,8 mm Messingrohr. Sie sind vorgepoliert aber nicht lackiert, können verlötet oder verschraubt werden. Beim Einbau sind die jeweils gültigen Vorschriften zu beachten und einzuhalten.

ENGLISH : A new style wich has come to us from across the Atlantic. These solid brass fittings offer you a new architectural concept in railings. Fittings for 38 or 50,8 mm (1 1/2" or 2") brass tubes. In order to cut down polishing time, they have been prepolished but not lacquered. The connections can be made using a uniquely designed screw expansion system or the traditional method of brazing. It is the responsibility of the installer to ensure compliance with building code requirements.

NEDERLANDS : Een kijk op iets nieuws uit de USA. Deze messing verbindingsstukken bieden nieuwe architectonische mogelijkheden. Zij zijn passend voor ca 38 en 50,8 mm messing buis. Om verdere verwerking te vergemakkelijken zijn deze voorgepolijst, echter niet gelakt. De verbindingen kunnen gesoldeerd en geschroefd worden. Neem de vereiste plaatselijke voorschriften in acht.

ESPAÑOL : Un look que nos llega de EEUU : Estas juntas de latón le ofrecen nuevas alternativas arquitectónicas. Están previamente pulidas, pero no barnizadas, para facilitar el trabajo de pulido final. Las uniones de efectúan mediante soldadura autógena ó atornillando. Están previstas para tubos de 38 mm y 50.8 mm. Es responsabilidad de los instaladores respetar las normas de construcción.

RUSSE : Новый стиль, пришедший к нам из-за Атлантического океана. Эти латунные соединительные детали предлагают Вам новые архитектурные концепции ограждений. Соединительные детали для латунных труб диаметром 38 или 50,8 мм (1 1/2" или 2"). Для того чтобы уменьшить время полировки, они были предварительно полированы, но не лакированы. Соединение может быть осуществлено при помощи специально разработанной расширительной системы отверстий для болтов или традиционного метода высокотемпературной пайки. Ответственность за соответствие со всеми строительными нормами и стандартами ложится на монтажника.



NEW-YORK

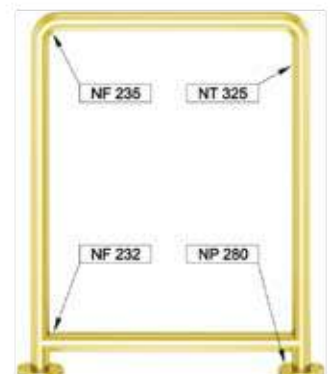
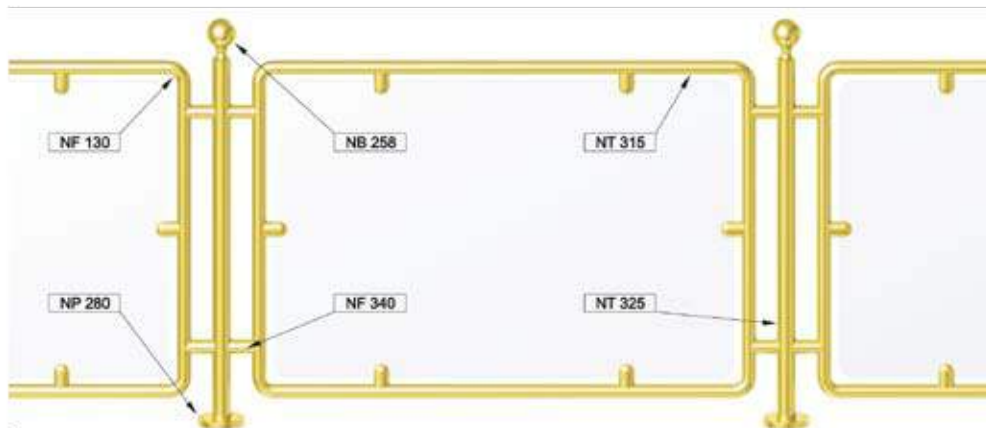
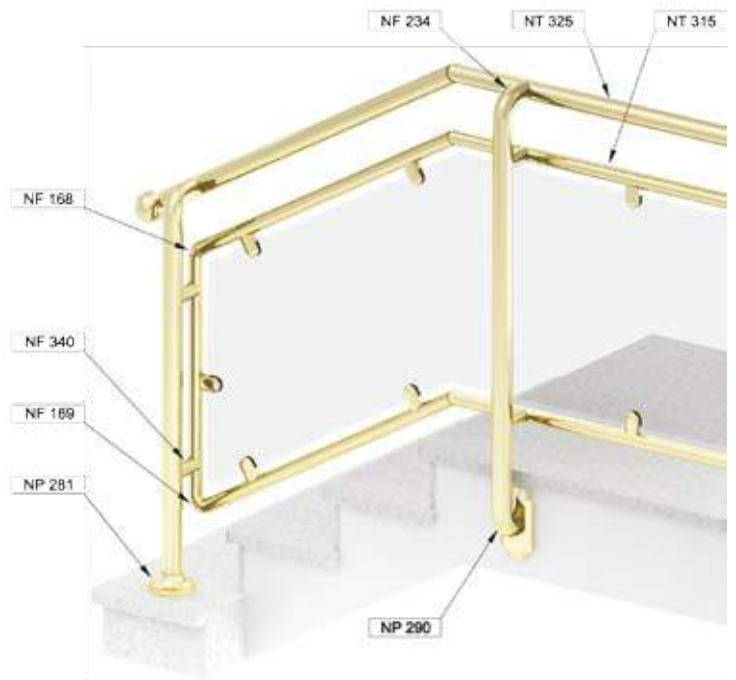
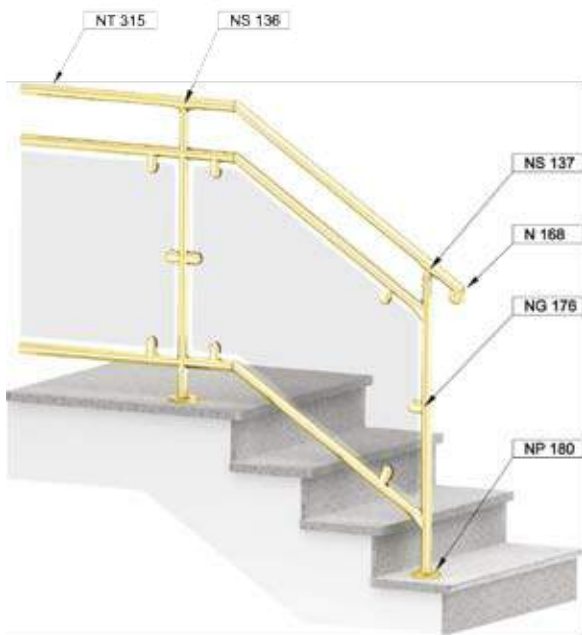
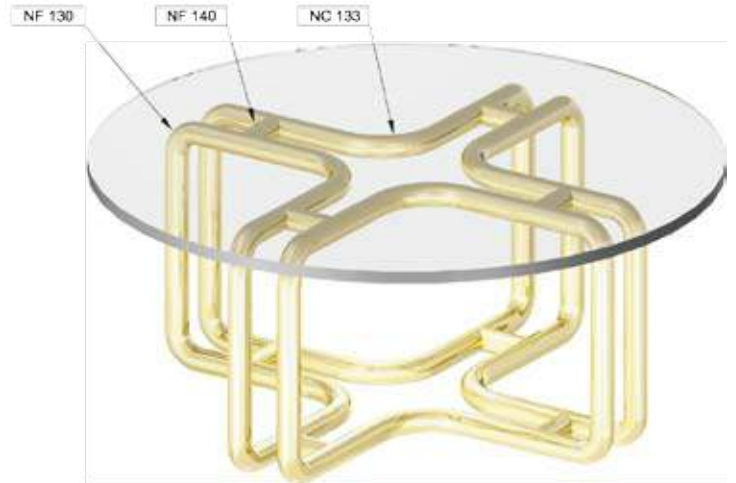
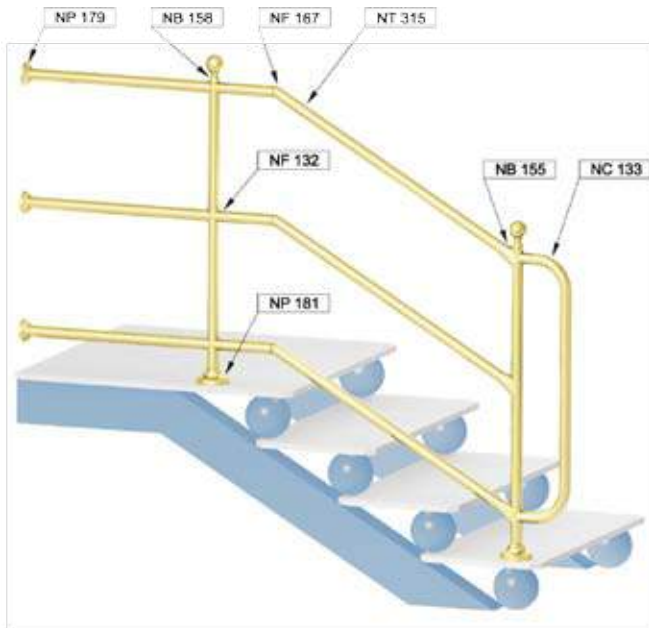

NEW-YORK

FRANÇAIS : Coudes à angle. Fixation du tube par système à expansion.

DEUTSCH : 90° Winkel mit Klemmsystem.

ENGLISH : Angled elbows. Attachment of the tube by expansion system.

NEDERLANDS : Klemverbindingsbochten 90°.

ESPAÑOL : Codos con ángulo recto (90°). Fijación al tubo por expansión.

RUSSE : Угловые локти. Присоединение трубки с помощью системы расширения.



| | | |
|----------|---------------|-------------|
| Ø 38,1 | NF 130 | A = 65mm |
| Ø 1 1/2" | | A = 2 9/16" |
| Ø 50,8 | NF 230 | A = 78mm |
| Ø 2" | | A = 3 1/16" |

| | | |
|----------|---------------|------------|
| Ø 38,1 | NF 131 | B = 47mm |
| Ø 1 1/2" | | B = 1 7/8" |
| Ø 50,8 | NF 231 | B = 60mm |
| Ø 2" | | B = 2 3/8" |

FRANÇAIS : Entretoises pivotantes pour toutes inclinaisons de rampe.

Livrées avec vis de fixation.

DEUTSCH : Distanzstücke- verdrehbar und passend für alle Treppenneigungen. Lieferung mit Befestigungsschraube.

ENGLISH : Pivotal spacer to match varying degrees of pitch. Supplied with fixing screw.

NEDERLANDS : Instelbare afstandsstukken voor elke leuningschuimte, inclusief bevestigingsroeven.

ESPAÑOL : Uniones pivotantes para todas las inclinaciones de la barandilla.

Se suministra con tornillo de fijación.

RUSSE : Центральная распорка для подбора различных углов установки. В комплект входит крепежный винт.

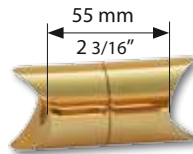

| | |
|----------|---------------|
| Ø 38,1 | NF 140 |
| Ø 1 1/2" | |
| Ø 50,8 | NF 240 |
| Ø 2" | |

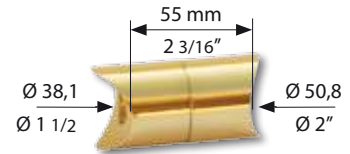

NF 340

FRANÇAIS : Pinces de fixation à base plane ou pour tube. Elles sont équipées d'une goupille de sécurité Ø 6 mm et de cales PUR pour plaques de verre d'épaisseur 7 à 9,52 mm. Livrées avec vis de fixation M 6.

DEUTSCH : Glashalter mit Flansch oder für Rohr-Basis. Ausgerüstet mit einem Ø 6 mm Sicherheitsstift und mit PUR Einlagen für 7 bis 9,52 mm Glasdicke. Geliefert mit M 6 Befestigungsschraube.

ENGLISH : Glassclips with flat or for pipe base. Equipped with a Ø 6 mm security pin and PUR wedge for 7 mm to 9,52 mm glass thickness. Delivered with an M 6 fixing screw.

NEDERLANDS : Glasklemmen voor bevestiging op wand of buis met een doorsnede. Geleverd met veiligheidsstift, Ø 6 mm en bevestigingschroef M 6. Klemmen voor glas met een dikte van 7 tot 9,52 mm, inclusief kunststof bescherming.

ESPAÑOL : Pinzas de fijación a base plana y a tubo. Equipadas con tetón de seguridad de Ø 6 mm. y calces de poliuretano para cristal de 7 a 9,52 mm. de espesor. Se suministran con tornillo de fijación M6.

RUSSE : Держатели стекла для ровной поверхности или для труб. Оснащены защитным болтом размером в Ø 6 мм и полиуретановым клином для стекла толщиной от 7 мм до 9,52 мм. В комплект также входит крепежный винт М 6.

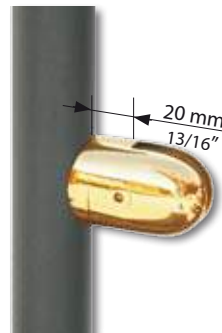

| | |
|----------|---------------|
| Ø 38,1 | NF 176 |
| Ø 1 1/2" | |
| Ø 50,8 | NF 276 |
| Ø 2" | |

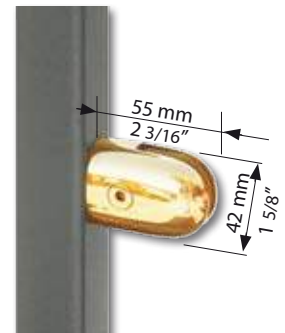

NF 376

FRANÇAIS : Platine murale à visser. Fixation du tube par soudo-brasage. Vis en laiton poli.

DEUTSCH : Wandrosette zum Aufschrauben. Rohrbefestigung durch Hartlöten. Senkkopfschrauben, Messing poliert.

ENGLISH : Wall flange. Suitable for brazing. Polished brass screws.

NEDERLANDS : Wanrozet voor buisbevestiging. De buis in de rozet solderen.

ESPAÑOL : Pletina para atornillar al mural. Fijación al tubo por soldadura autogena. Tornillo en latón pulido.

RUSSE : Пристенные фланцы: подходят для высокотемпературной пайки. Полированные латунные болты.



Vendu par 100 pcs
Send per 100 pcs

| | | |
|----------|---------------|--------------|
| Ø 38,1 | NP 179 | D = 75mm |
| Ø 1 1/2" | | D = 2 15/16" |
| Ø 50,8 | NP 279 | D = 100mm |
| Ø 2" | | D = 3 15/16" |

| | |
|------------|-------------|
| M5 x 15mm | NV 5 |
| M5 x 9/16" | |
| M6 x 25mm | NV 6 |
| M6 x 1" | |

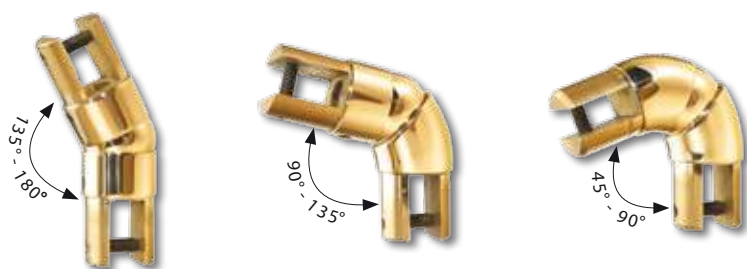

| | | | |
|--------------------|---------------|---------------|---------------|
| ∅ 38,1 ∅ 1 1/2" | NF 167 | NF 168 | NF 169 |
| ∅ 50,8 ∅ 2" | NF 267 | NF 268 | NF 269 |

FRANÇAIS : Coudes réglables à verrouillage extérieur. Fixation du tube par système à expansion.

DEUTSCH : Verstellbare Winkel mit Außenblockierung. Rohrbefestigung durch Klemmsystem.

ENGLISH : Adjustable elbows with external locking. Pipe is secured by expansion sleeves.

NEDERLANDS : Verstelbaar hoekverbindingsstuk met uitwendige blokkering.

ESPAÑOL : Codos regulables con apriete exterior. Fijación al tubo por expansión.

RUSSE : Регулируемые угловые соединители с внешним креплением. Труба оснащена раздвигающей втулкой.



| | | | |
|--------------------|---------------|---------------|---------------|
| ∅ 38,1 ∅ 1 1/2" | NF 132 | NF 133 | NF 332 |
| ∅ 50,8 ∅ 2" | NF 232 | NF 233 | |

FRANÇAIS : Raccord latéral avec système de blocage par expansion. Avec vis de fixation.

DEUTSCH : Querverbinder mit Klemmsystem. Lieferung mit Befestigungsschraube.

ENGLISH : Universal lateral fittings. Joints made by use of the screw expansion system. Supplied with fixing screw.

NEDERLANDS : Hoekverbindingsstukken met klemstysteem, inclusief bevestigingsschroeven.

ESPAÑOL : Pieza de unión lateral con sistema de bloqueo por expansión. Equipado con tornillo de fijación.

RUSSE : Универсальные регулируемые соединители с внешним креплением. Стыковка может быть осуществлена при помощи расширительной системы отверстий для болтов. В комплект входит крепежный винт.



| | | | |
|--------------------|--------------|--------------|---------------|
| ∅ 38,1 ∅ 1 1/2" | N 168 | N 170 | NF 166 |
| ∅ 50,8 ∅ 2" | N 268 | N 270 | NF 266 |

FRANÇAIS : Embouts de fermeture et pièce de jonction pour 2 tubes.

DEUTSCH : Rohrendkappen. Rohrverbinder mit Klemmsystem.

ENGLISH : Endcaps and tube connector using expansion system.

NEDERLANDS : Eindkappen voor buisafwerking. Verbindingsstuk voor 2 buizen.

ESPAÑOL : Extremos de cierre y pieza de unión para dos tubos.

RUSSE : Заглушки и соединители труб, использующие расширительную систему.

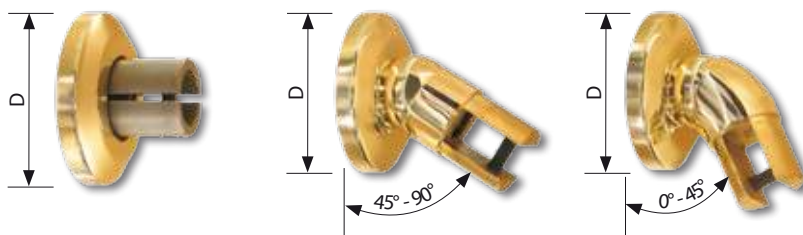

∅ 38,1 ∅ D: 80mm - 3 1/8"
∅ 50,8 ∅ D: 110mm - 4 5/16"

| | | | |
|--------------------|---------------|---------------|---------------|
| ∅ 38,1 ∅ 1 1/2" | NP 182 | NP 178 | NP 177 |
| ∅ 50,8 ∅ 2" | NP 282 | NP 278 | NP 277 |

FRANÇAIS : Supports muraux, fixe et réglable. Platinas en fer et vis de fixation recouverts par cache-scellements en laiton.

DEUTSCH : Wandflansche - fest und verstellbar mit Klemmverbindung. Die Stahlmontageplatten mit Befestigungsschrauben werden durch die Messingrosette verdeckt.

ENGLISH : Wall flanges: fixed and adjustable. Tube connected to flange using especially designed expansion system. Wall fixing plates and screws covered by brass collars.

NEDERLANDS : Wand- en vloerbevestiging : vaste en verstellbare uitvoering met klemverbindingen. De metalen montageplaat met bevestigingsschroeven wordt afgedekt met een messing rozet.

ESPAÑOL : Soportes para mural, fijo y regulable. Pletina de hierro y tornillos de fijación cubiertos con embellecedor.

RUSSE : Пристенные фланцы: установлены и регулируются. Труба соединена с фланцем при помощи специально разработанной расширительной системы. Пристенные крепящие пластины и болты, покрытые латунными фланцами.

FRANÇAIS : Support de main courante et support de tube à fixation apparente ou non. Vis de fixation fournies.

DEUTSCH : Handlauf - und Rohrträger mit sichtbarer oder unsichtbarer Befestigung. Geliefert mit Befestigungsschrauben.

ENGLISH : Handrail bracket and tube holder with visible fixing or not. Supplied with fixing screws.

NEDERLANDS : Muurleuning - en buisdragers met zichtbare of blinde bevestiging. Inclusief bevestigingsschroeven.

ESPAÑOL : Soporte para pasamanos y soporte de tubo con fijación vista o no. Se suministra con tornillos de fijación.

RUSSE : Держатели поручней и труб с видимым или с невидимым креплением. Оснащены крепежными болтами.



| | | | |
|--------------------|---------------|---------------|---------------|
| Ø 38,1 Ø 1 1/2" | NS 172 | NS 173 | NS 192 |
| Ø 50,8 Ø 2" | NS 272 | | |

FRANÇAIS : Sphères pour poteaux.

Coudes supérieurs pour poteaux. Le raccord haut est pivotant s'accordant à toute inclinaison de rampe. Au bas un filetage intérieur M 18. Tige filetée non fournie.

DEUTSCH : Pfostenabschlusskugel mit Innengewinde M18. Winkелеlemente. Das obere Anschlußteil ist verdrehbar und passend für alle Treppeneigungen. Das untere Teil hat ein M 18 Innengewinde. Lieferung ohne Gewindestange.

ENGLISH : Ball Fittings for post. The NB158 & NB258 are equipped with a M18 threaded hole. Flush top-elbows for posts. The upper part is adjustable to match the off-set angle. The lower part is equipped with a M 18 threaded hole, without the threaded rod.

NEDERLANDS : Eindafwerkingsstukken voor hoofdbalusters. NB158 & NB258 met M18 inwendige schroefdraad. Hoek-, bovenstuk voor balusters. Het boven-aansluitdeel is draaibaar voor elke leuningschuimte. Het onderstuk heeft M 18 inwendige schroefdraad. Levering zonder draadstang.

ESPAÑOL : Esferas para balaustres. Las piezas NB158 & NB258 tienen un taladro inferior roscado a M18. Codos superiores para balaustres. La unión superior es pivotante pudiéndose adaptar a cualquier inclinación de la barandilla. La parte inferior tiene un rosca interior de M 18. Se suministra sin la varilla roscada.

RUSSE : Шаровой шарнир для опоры. NB158 и NB258 оснащён резьбовым отверстием M18. Скрытый угловой соединитель для опоры. Верхняя часть регулируется для угла смещения. Нижняя часть оснащена резьбовым отверстием M 18. Резьбовой стержень отсутствует



| | | | |
|--------------------|---------------|---------------|---------------|
| Ø 38,1 Ø 1 1/2" | NB 158 | NF 134 | NF 135 |
| Ø 50,8 Ø 2" | NB 258 | NF 234 | NF 235 |

FRANÇAIS : Connexion articulée (48°/68°). Mise en œuvre aisée grâce au verrouillage extérieur. Livré avec vis de fixation. Pièce de jonction. Pièces supérieures de poteaux, fixes et réglables (60°).

DEUTSCH : Gelenkverbindung (48°/68°). Einfache Benützung durch Außenblockierung. Geliefert mit Befestigungsschraube. Rohrstützen für Pfosten mit M18 Innengewinde fest und verstellbar. Lieferung ohne Gewindestange.

ENGLISH : Adjustable fitting (48°/68°). Easy to use due to the external locking. Secured by expansion sleeves.

Straight and adjustable (60°) saddles. Without the threaded rod.

NEDERLANDS : Verstelbaar hoekverbindingsstuk (48°/68°), eenvoudig bij montage door uitwendige blokkering.

Verstelbare buissteun (60°) voor balusters met inwendige schroefdraad.

ESPAÑOL : Conexión articulada (48°/68°). Facilidad de montaje gracias al atornillado exterior. Se suministran con tornillo de fijación.

Piezas superiores para balaustres, fijos y regulables (60°). Se suministra sin la varilla roscada.

RUSSE : Регулируемые соединительные детали (48°/68°). Легки в применении благодаря внешнему креплению. Оснащены раздвигающей втулкой. Прямые и регулируемые (60°) седловины. Резьбовой стержень отсутствует.

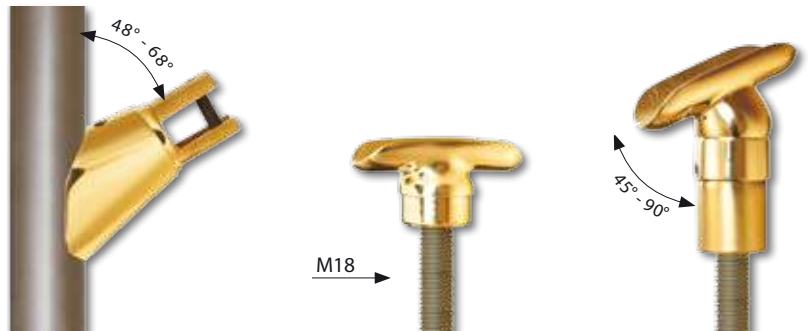

| | | | |
|--------------------|---------------|---------------|---------------|
| Ø 38,1 Ø 1 1/2" | NB 155 | NS 136 | NS 137 |
| Ø 50,8 Ø 2" | NB 255 | NS 236 | NS 237 |

FRANÇAIS : Platine de base pour poteau, avec filetage M 18. Livrée avec 4 vis à bois 8/so mm, en laiton poli.

DEUTSCH : Bodenplatte für Pfosten mit Innengewinde M 18. Lieferung mit Messingholzschrauben (4 Stück 8 x 80 poliert).

ENGLISH : Post flange with a M 18 threaded hole. Delivered with four 8/so polished brass screws.

NEDERLANDS : Messing vloerrozet voor hoofdbaluster, met M 18 inwendige schroefdraad en M8/so mm messing gepolijste houtschroeven.

ESPAÑOL : Pletina-base para balaustra, con rosca de M 18.

Recibida con 4 tornillos para madera de 8/so mm, en latón pulido.

RUSSE : Опорный фланец с резьбовым отверстием M 18. В комплект входят 4 полированных латунных болта.



| | | |
|--------------------|---------------|-------------------------|
| Ø 38,1 Ø 1 1/2" | NP 180 | D = 110mm |
| Ø 50,8 Ø 2" | NP 280 | D = 120mm D = 4 3/4" |

FRANÇAIS : Éléments de base pour poteaux : ils sont équipés d'un filetage intérieur M 18. Les platines de fixation en fer sont recouvertes par le cache-scèlement en laiton. Tige filetée non fournie.

DEUTSCH : Wand- und Bodenanker mit Innengewinde M 18 und Messing - Abdeckrosette. Lieferung ohne Gewindestange.

ENGLISH : Post bases: They are equipped with a M 18 threaded hole. The fixing plates are covered by the brass caps. Delivered without the threaded rod.

NEDERLANDS : Baluster-, vloer- en zijkantbevestiging : uitgevoerd met M 18 inwendige schroefdraad. De metalen montageplaten zijn afgedekt met een messing rozet. Levering zonder draadstang.

ESPAÑOL : Componentes de base para balaustres: Las pletinas de fijación de hierro tienen una rosca interior de M 18 y se recubren con la tapa-embellecedor de latón. Se suministra sin la varilla roscada.

RUSSE : Опорные основы: Оснащены резьбовым отверстием M 18. Крепящие пластины покрыты латунными колпаками. Резьбовой стержень в комплект не входит.

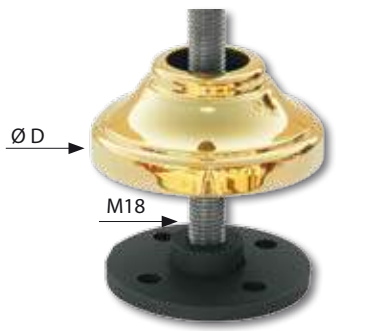

| | | |
|--------------------|---------------|-------------------------|
| Ø 38,1 Ø 1 1/2" | NP 181 | D = 110mm |
| Ø 50,8 Ø 2" | NP 281 | D = 120mm D = 4 3/4" |

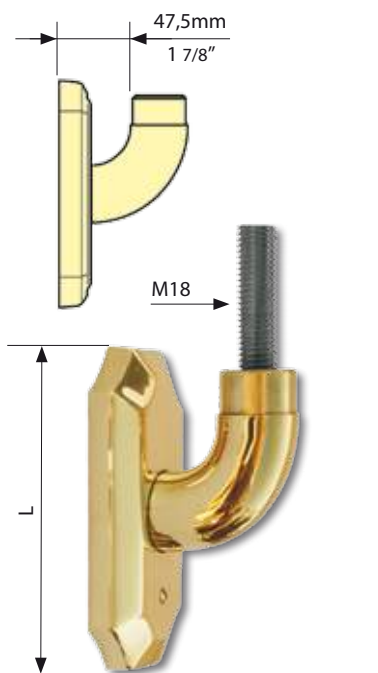

| | | |
|--------------------|---------------|------------------------------------|
| Ø 38,1 Ø 1 1/2" | NP 190 | L = 152mm |
| Ø 50,8 Ø 2" | NP 290 | L = 6" L = 182mm L = 7 3/16" |

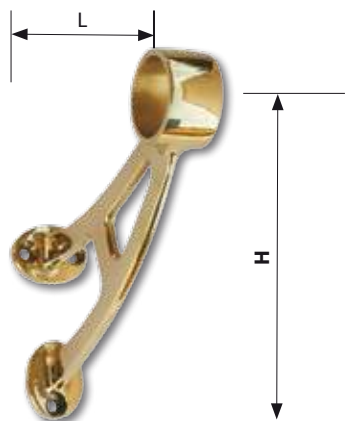

| | | | |
|----------|---------------|-------------|------------|
| ∅ 38,1 | NS 186 | L = 154mm | H = 130mm |
| ∅ 1 1/2" | | L = 6 1/16" | H = 5 1/8" |
| ∅ 50,8 | NS 286 | L = 172mm | H = 120mm |
| ∅ 2" | | L = 6 3/4" | H = 5 1/2" |

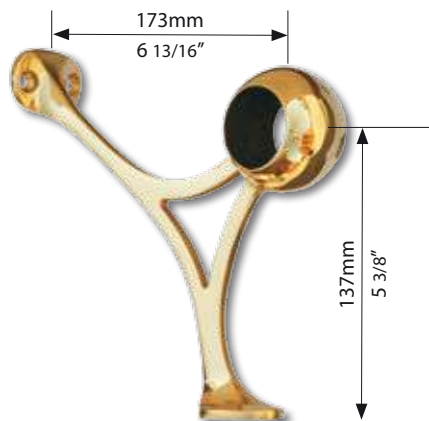

| | |
|----------|---------------|
| ∅ 38,1 | NS 187 |
| ∅ 1 1/2" | |



| | |
|--------|---------------|
| ∅ 50,8 | NS 287 |
| ∅ 2" | |

Support fermé
End post
Handlauf Halter
Geschlossen
Soporte ciego
Концевая стойка

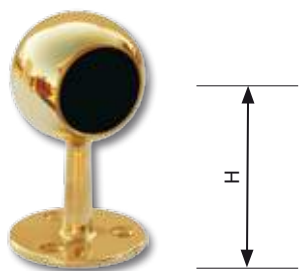

| | | |
|----------|---------------|--------------|
| ∅ 38,1 | NS 169 | H = 75mm |
| ∅ 1 1/2" | | H = 2 15/16" |
| ∅ 50,8 | NS 269 | H = 80mm |
| ∅ 2" | | H = 3 1/8" |

Support traversant
Center post
Handlauf Halter
Durchgehend
Soporte transversal
Средняя стойка



| |
|---------------|
| NS 171 |
| NS 271 |

Support de verres à vin - Weinglashalter - Wine glass rack
Wijnloasrek - Soporte para vasos de vino - Стойка «винный бокал»

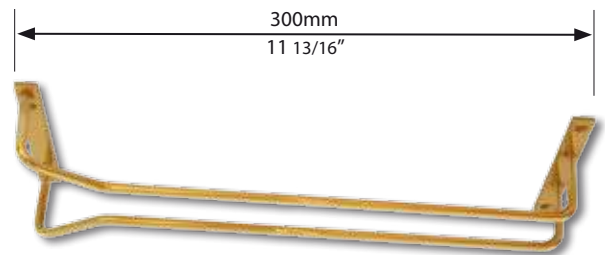

| |
|---------------|
| NG 185 |
|---------------|

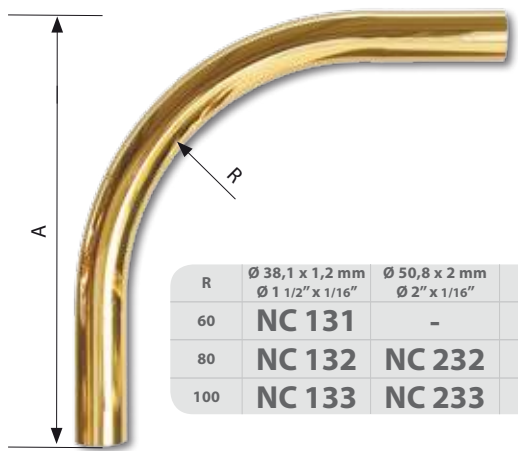

| R | ∅ 38,1 x 1,2 mm ∅ 1 1/2" x 1/16" | ∅ 50,8 x 2 mm ∅ 2" x 1/16" | A |
|-----|-------------------------------------|-------------------------------|-----|
| 60 | NC 131 | - | 130 |
| 80 | NC 132 | NC 232 | 175 |
| 100 | NC 133 | NC 233 | 200 |

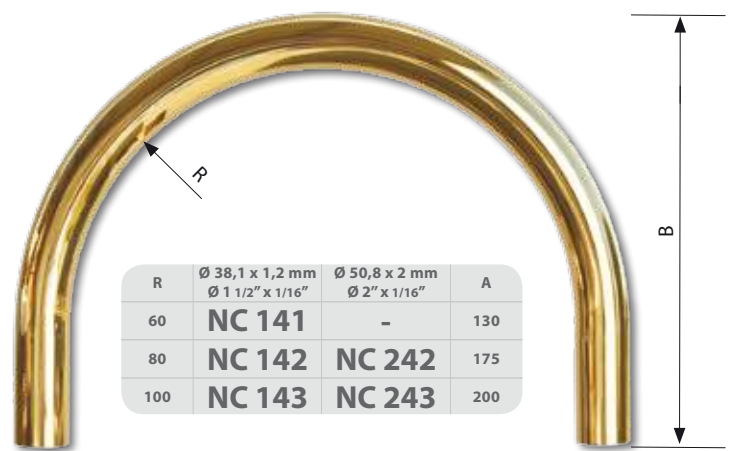

| R | ∅ 38,1 x 1,2 mm ∅ 1 1/2" x 1/16" | ∅ 50,8 x 2 mm ∅ 2" x 1/16" | A |
|-----|-------------------------------------|-------------------------------|-----|
| 60 | NC 141 | - | 130 |
| 80 | NC 142 | NC 242 | 175 |
| 100 | NC 143 | NC 243 | 200 |



| | | |
|----------|-------------|---------------|
| ∅ 38,1 | L = 3000 mm | NT 315 |
| ∅ 1 1/2" | L = 118" | |
| ∅ 50,8 | L = 3000 mm | NT 325 |
| ∅ 2" | L = 118" | |

**BOULES MASSIVES
VOLLKUGELN
SOLID BALLS
MASSIEVE BOLLEN
BOLAS MACIZAS
ЦЕЛЬНЫЕ ШАРЫ**

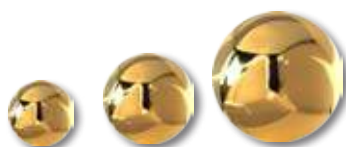

Verni - Lacquered - Lackiert - Barnizado - Покрыты лаком

| | | |
|---------------------|------|--------------|
| D: 15 mm 9/16" | M 6 | KL 15 |
| D: 20 mm 3/4" | M 6 | KL 20 |
| D: 25 mm 1" | M 6 | KL 25 |
| D: 30 mm 1 3/16" | M 8 | KL 30 |
| D: 40 mm 1 9/16" | M 10 | KL 40 |

**BOULES CREUSES
HOHLKUGELN
HOLLOW BALLS
HOLLE BOLEN
BOLAS HUECAS
ПОЛЫЕ ШАРЫ**



Verni - Lacquered - Lackiert - Barnizado - Покрыты лаком

| | | |
|-----------------------|------|---------------|
| D: 50 mm 2" | M 10 | KL 50 |
| D: 75 mm 3" | M 10 | KL 75 |
| D: 100 mm 3 15/16" | M 12 | KL 100 |
| D: 130 mm 5 1/8" | M 12 | KL 130 |

FRANÇAIS : Vernis acrylique en aérosol. Contenu : 0,40 L. Convient particulièrement pour la protection des pièces en laiton et bronze. Conseillé pour retouches ou petits travaux uniquement. Pour une protection supérieure nous recommandons le vernis XV2.

DEUTSCH : Klarlack Spray - Acryl Basis. Inhalt: 0,40 L. Besonders geeignet für Messing- und Bronzeteile. Nur geeignet für Nachbearbeitungen oder kleinere Teile. Für einen höheren Schutz empfehlen wir den XV2 Lack.

ENGLISH : Transparent lacquer spray, acrylic based. Size: 0,40 liter. Especially suited for brass and bronze items. Use for touchups or small projects only. For greater protection out of doors we recommend XV2 lacquer.

NEDERLANDS : Blanke lak spray - acryl basis. Inhoud: 0,40 ltr. Speciaal bruikbaar voor messing en bronzen componenten. Alleen geschikt voor nabewerking of kleine onderdelen. Voor een betere bescherming wordt de XV2 lak aanbevolen.

ESPAÑOL : Barniz acrílico en aerosol. Contenido : 0,40 L. Adecuado particularmente para la protección de piezas de latón o bronce. Aconsejado únicamente para retoques o pequeños trabajos. Para una protección superior, recomendamos el barniz XV2.

RUSSE : Прозрачный акриловый лак-аэрозоль. Объем: 0,40 литра. Особенно подходит для изделий из меди и бронзы. Используется только



XV 1

FRANÇAIS : Vernis à base de polyuréthane à 2 composants. Livré en carton contenant 1 litre de vernis avec durcisseur et 1 litre de diluant. Excellent pour la protection des pièces en laiton. Les éléments vernis ne doivent pas être exposés à une température supérieure à 110°C.

DEUTSCH : Zweikomponentenlack auf Polyurethan-Basis. Lieferbar im geschlossenen Karton. Inhalt: 1 Liter Lack mit Härter und 1 Liter Verdünnung. Besonders zum Schutz von Messingteilen geeignet. Die lackierten Teile dürfen nicht einer Temperatur höher als 110°C ausgesetzt werden.

ENGLISH : Polyurethane based lacquer. Supplied complete with 1 litre of lacquer, hardener and thinner. Excellent for the protection of brass items. Lacquered items should not be exposed to temperatures greater than 110°C.

FRANÇAIS : Gabarit de perçage. Ce coffret comprend les éléments indispensables pour réaliser les perçages nécessaires au montage, en garantissant leur alignement et position de façon rigoureuse.

DEUTSCH : Bohrschablone. In dieser Box finden Sie das Zubehör, um problemlos die notwendigen Bohrungen vorzunehmen.

ENGLISH : Drilling template. This presentation box comprises the components indispensable to make the necessary drillings for the assembly, by guaranteeing rigorously their alignment and position.

NEDERLANDS : Boorsjabloon. Deze kit bevat onmisbare hulpmiddelen om de nodige boringen te maken voor een juiste positionering en assemblage.

ESPAÑOL : Útil para taladrar. Esta caja comprende los elementos indispensables para realizar los taladros necesarios en el montaje, garantizando su alineamiento y posición de forma rigurosa.

RUSSE : Набор образцов для сверления. Этот презентационный набор сочетает в себе компоненты, необходимые для того, чтобы просверлить необходимые для монтажа отверстия, гарантируя точную регулировку и расположение.

ЗАМЕТКИ - УКАЗАТЕЛИ

NEDERLANDS : Twee componenten, Polyurethaan blanke basislak, uitsluitend . Leverbaar in gesloten verpakking. Inhoud : 1 ltr. lak met verharder, 1 ltr. verdunner. Speciaal bruikbaar voor messing componenten. De gelakte delen niet blootstellen aan een temperatuur hoger dan 110°C.

ESPAÑOL : Barniz Poliuretano dos componentes. Suministrado en caja de cartón conteniendo 1L. de Barniz con endurecedor y 1L. de disolvente. Excelente para la protección de piezas de latón. Los elementos barnizados no deben ser expuestos a temperaturas superiores a 110°C.

RUSSE : Полиуретановый лак. Поставляется в комплекте: 1 литр лака, отвердитель и растворитель. Идеально подходит для защиты изделий из меди. Лакированные изделия не должны подвергаться воздействию температур выше 110оС.



XV 2

FRANÇAIS : Présentoir « New-York ». Cet ensemble, offert à un prix très attractif, vous permettra de faire apprécier à vos clients la qualité des composants «New-York».

DEUTSCH : "New-York"-Anwendungsbeispiel. Dieser zu einem besonders günstigen Preis angebotene Musterständer erlaubt Ihnen die "New-York"-Einzelteile Ihrem Kunden näher zu erläutern.

ENGLISH : "New-York" display. This set, offered to a very attractive price, will allow your customers to really appreciate the quality of the "New-York" components.

NEDERLANDS : Presentatiedisplay "New-York". Deze samenstelling van verschillende componenten, leverbaar tegen een aantrekkelijke prijs, geeft een duidelijk beeld over de kwaliteit van het "New-York" programma.

ESPAÑOL : Muestrario "New-York". Este ensamblaje, con un precio muy atractivo, le permitirá hacer apreciar a sus clientes la calidad de los componentes "New-York".

RUSSE : Набор образцов "New-York". Этот набор, предложенный по очень привлекательной цене, позволяет Вашим клиентам по-настоящему оценить компоненты серии "New-York".



Ø 38,1
Ø 1 1/2"
Ø 50,8
Ø 2"

NJ 15
NJ 20



Ø 38,1
Ø 1 1/2"

NY 38





INOX

SKYPORT

FRANÇAIS : Le choix des matières est très important dans le style de décoration intérieure zen, car ce sont elles qui vont rendre votre intérieur douillet et chaleureux, sans pour autant le surcharger. La collection SKYPORT est composée de barreaux aux lignes épurées, très sobres en acier inoxydable. Les colliers de jonction sont en deux finitions différentes, finement émerisés ou polis brillant, puis revêtus au nitrure de titane (TIN) pour un aspect doré pratiquement inaltérable.

ENGLISH : The choice of materials is very important in the style of Zen decoration, because they are the ones that will make your interior or exterior cozy and warm, without overloading it. The SKYPORT collection consists of balusters with pure lines, very sober in stainless steel. The junction collars are in two different finishes, finely polished, then coated with titanium nitride (tin) for a nearly unalterable gilded aspect.

DEUTSCH : Die Wahl der Materialien ist sehr wichtig für den Zen-Einrichtungsstil, da sie Ihr Interieur gemütlich und warm machen, ohne es zu überlasten. Die SKYPORT-Kollektion besteht aus Stangen mit klaren Linien und sehr nüchternem Edelstahl. Die Verbindungsmanschetten sind in zwei verschiedenen Ausführungen erhältlich, fein geschliffen oder glänzend poliert und anschließend mit Titanitrid (TIN) beschichtet, um ein nahezu unveränderliches goldenes Erscheinungsbild zu erzielen.

NEDERLAND : De materiaalkeuze is erg belangrijk in de Zen-interieurstijl, omdat zij uw interieur gezellig en warm maken, zonder het te overbelasten. De SKYPORT-collectie bestaat uit staven met strakke lijnen, zeer sober roestvrij staal. De verbindingskragen zijn in twee verschillende afwerkingen, fijn opgemaakt of glanzend gepolijst, vervolgens bekleed met titaniumnitride (TIN) voor een vrijwel onveranderlijk gouden uiterlijk.

ESPAÑOL : La elección de los materiales es muy importante en el estilo de decoración de interiores Zen, ya que son los que harán que su interior sea acogedor y cálido, sin sobrecargarlo. La colección SKYPORT está compuesta por barras con líneas limpias, acero inoxidable muy sobrio. Los collares de unión están en dos acabados diferentes, finamente emergidos o pulidos con brillo, luego recubiertos con nitruro de titanio (TIN) para una apariencia dorada prácticamente inalterable.

RUSSE : Выбор материалов очень важен в стиле внутренней отделки Zen, потому что именно они сделают ваш интерьер уютным и теплым, не перегружая его. Коллекция SKYPORT состоит из стержней с чистыми линиями, очень трезвая из нержавеющей стали. Соединительные хомуты имеют две различные отделки: тонко обработанные или полированные, а затем покрытые нитридом титана (TIN) для практически неизменного золотистого цвета.



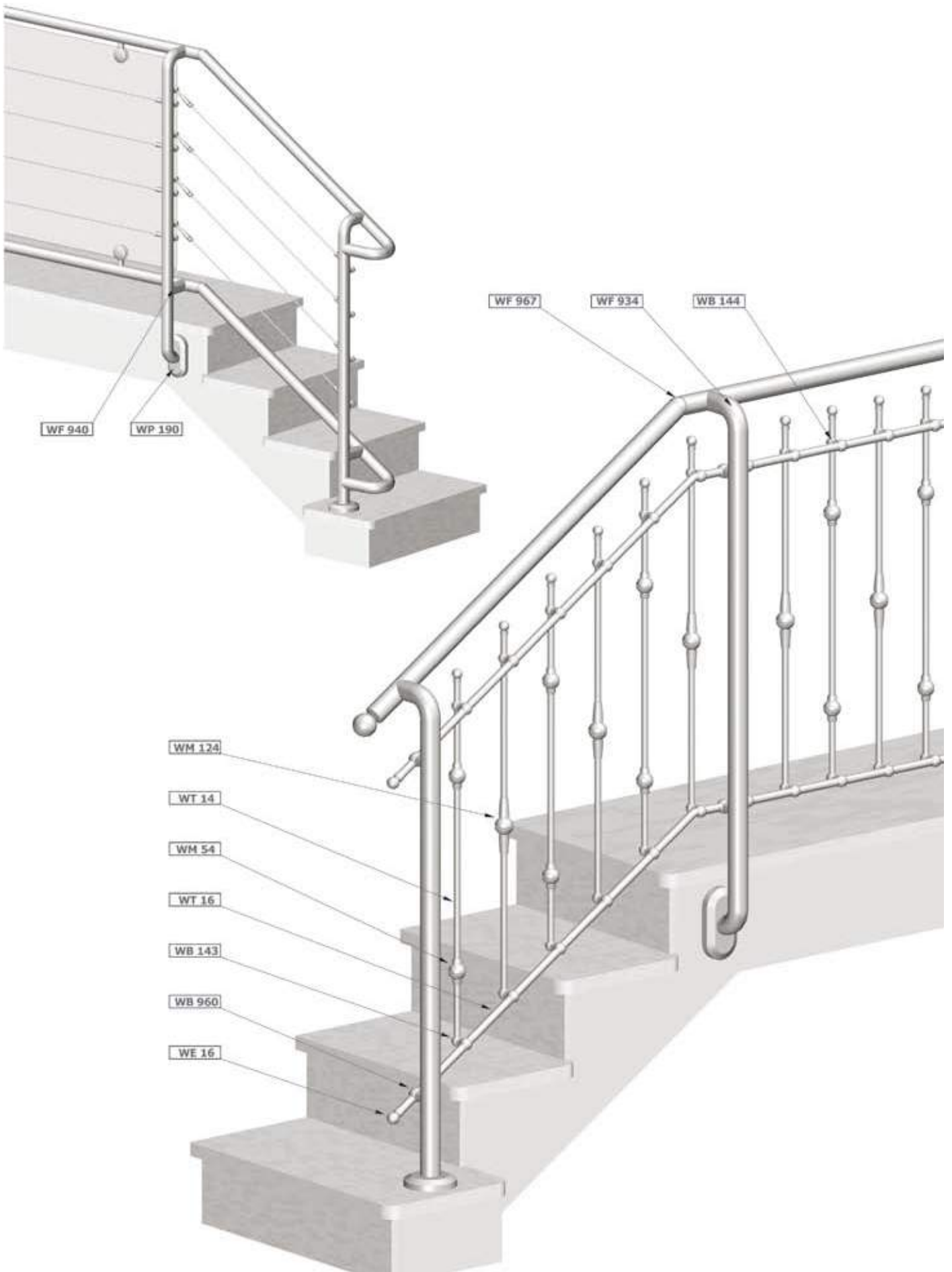

Inox 304 (V2A)

FRANÇAIS : l'inox 304 est à utiliser à l'intérieur exclusivement.

DEUTSCH : Die Produkte in der Qualität 304 (V2A) empfehlen wir für den Innenbereich.

ENGLISH : We recommend products in quality 304 (V2A) for indoor use.

NEDERLANDS : de producten in de kwaliteit 304 zijn bedoeld voor interieur toepassingen.

ESPAÑOL : Los productos en la calidad 304 (V2A) se recomiendan para el uso en interiores.

RUSSE : Мы рекомендуем товар нижеследующего качества: качество 304 (V2A) для внутреннего использования.

Inox 316 (V4A)

FRANÇAIS : L'inox 316 convient tout particulièrement à l'extérieur. Nous préconisons une passivation immédiatement après assemblage sur chantier avec notre CLEANER. Si le produit est installé en milieu agressif (bord de mer, zone industrielle, piscine...) la surface peut se ternir. Dans ce cas, nous conseillons également d'utiliser notre CLEANER pour raviver les surfaces.

DEUTSCH : Produkte in der Qualität V4A sind besonders für den Außeneinsatz geeignet. Nach der Montage vor Ort empfiehlt sich die Verwendung mit CLEANER. Speziell bei extremen Witterungs- und Umwelteinflüssen, wie sie beispielsweise an der Küste, in Industrienähe oder in Schwimmbädern vorherrschen, kann sich Flugrost ansetzen. Auch dann empfiehlt sich eine auffrischende Grundreinigung mit CLEANER.

ENGLISH : Some SKYPORT railing systems are not recommended for outdoor use in coastal environments nor in chlorinated or industrial locations due to possible corrosion. Sea spray is highly corrosive. Railing components of type 316 are especially resistant to corrosion. After all installations, it is recommended that the railing be treated with the cleaner CLEANER to increase its passivity to corrosion. The above cleaner may be obtained from Grand Forge. Use cleaner with care and follow instructions as stated on the container.

NEDERLANDS : Producten vervaardigd uit RVS type 316 (V4A) zijn uitermate geschikt voor buitentoepassing. Na montage en installatie wordt behandeling met CLEANER aanbevolen. Met name bij extreme weers- en omgevingsinvloeden, zoals aan de kust, in industriegebieden of zwembaden, kan vliegroest ontstaan. Voor een grondige reiniging van bestaande situaties is gebruik van CLEANER aanbevolen.

ESPAÑOL : El inoxidable 316 es particularmente conveniente en el exterior. Recomendamos la aplicación, inmediatamente después del montaje en obra, de nuestro CLEANER. Si el producto está instalado en medio agresivo (borde del mar, zonas industriales, piscinas...) la superficie puede resultar manchada. En este caso, aconsejamos igualmente utilizar nuestro CLEANER para reavivar las superficies.

RUSSE : Некоторые системы ограждения серии SKYPORT не рекомендуются для наружного использования в прибрежной среде, а также в хлоросодержащей среде и в местах размещения промышленных объектов, по причине возможности коррозии металла. Морские капли высококоррозионны. Компоненты ограждений типа 316 – особо коррозионностойкие. После окончания монтажа рекомендуется обработать ограждения детергентом CLEANER, чтобы повысить степень устойчивости к коррозии. Вышеупомянутый детергент может быть приобретен в компании Grand Forge. Используйте детергент осторожно и следуйте инструкциям на упаковке.



FRANÇAIS : Eléments de base pour poteaux. Exécution lourde. Fixation du tube par système à expansion. Résistance à la flexion supérieure à celle du tube, sous réserve d'un support solide et adéquat. (Couple max. admissible: 520mN).

DEUTSCH : Pfostenbefestigung. Schwere Ausführung. Rohrbefestigung durch Klemmsystem. Die Befestigungsteile haben eine höhere Festigkeit als die Durchbiegung des Rohres. Eine entscheidende Voraussetzung zur Befestigung ist die Kenntnis über den vorhandenen Untergrund und die Auswahl des richtigen Dübel-systems (Drehmoment 520mN maxi.)

ENGLISH : Post bases. Rigid, heavy duty. Tubing is rigidly secured by means of expansion sleeves. Resistance to bending higher than that of the tube provided the base is solid and adequate (Maximum torque: 520mN).

NEDERLANDS : Balusterbevestiging. Zware uitvoering. Buisbevestiging door klem-systeem. De bevestigingsdelen hebben een betere stevigheid als het doorbuigen van de buis. Een bepalende voorwaarde voor bevestiging is de kennis van de constructieve ondergrond, het toetsen aan het Bouwbesluit en de keuze van het juiste bevestigingssysteem (Maximumkoppel: 520mN).

ESPAÑOL : Elementos de base para arranques. Construcciones pesadas. Fijación del tubo por sistema de expansión. Resistencia a la flexión superior a la del tubo, siempre que el soporte sea sólido y adecuado (Par máximo: 520mN).

RUSSE : Опоры для стоек. Устойчивы, выносят большие нагрузки. Благодаря закладной втулке, труба устойчиво закреплена. Степень сопротивления сгибанию выше, чем у трубы с аналогичной, однако цельной основой. (максимальный момент: 520мН).

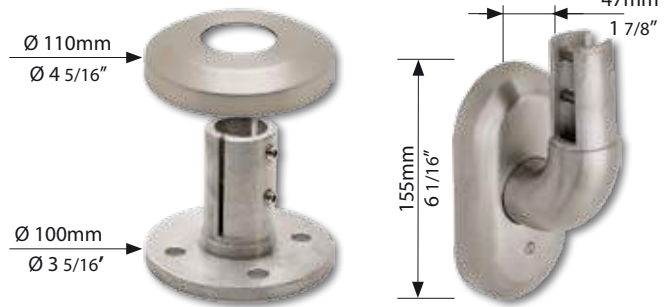

| | | | |
|----------------|-------------------------------|--------|--------|
| AISI 304 (V2A) | Tube Ø 42,4mm Tube Ø 1,66" | WP 181 | WP 190 |
| AISI 316 (V4A) | Tube Ø 42,4mm Tube Ø 1,66" | WP 981 | WP 990 |

FRANÇAIS : Eléments de base pour poteaux. Exécution lourde. Fixation du tube par système à expansion. Résistance à la flexion supérieure à celle du tube, sous réserve d'un support solide et adéquat. (Couple max. admissible: 2000mN).

DEUTSCH : Pfostenbefestigung. Schwere Ausführung. Rohrbefestigung durch Klemmsystem. Die Befestigungsteile haben eine höhere Festigkeit als die Durchbiegung des Rohres. Eine entscheidende Voraussetzung zur Befestigung ist die Kenntnis über den vorhandenen Untergrund und die Auswahl des richtigen Dübel-systems (Drehmoment 2000mN maxi.)

ENGLISH : Post bases. Rigid, heavy duty. Tubing is rigidly secured by means of expansion sleeves. Resistance to bending higher than that of the tube provided the base is solid and adequate (Maximum torque: 2000mN).

NEDERLANDS : Balusterbevestiging. Zware uitvoering. Buisbevestiging door klem-systeem. De bevestigingsdelen hebben een betere stevigheid als het doorbuigen van de buis. Een bepalende voorwaarde voor bevestiging is de kennis van de constructieve ondergrond, het toetsen aan het Bouwbesluit en de keuze van het juiste bevestigingssysteem (Maximumkoppel: 2000mN).

ESPAÑOL : Elementos de base para arranques. Construcciones pesadas. Fijación del tubo por sistema de expansión. Resistencia a la flexión superior a la del tubo, siempre que el soporte sea sólido y adecuado (Par máximo: 2000mN).

RUSSE : Опоры для стоек. Устойчивы, выносят большие нагрузки. Благодаря закладной втулке, труба устойчиво закреплена. Степень сопротивления сгибанию выше, чем у трубы с аналогичной, однако цельной основой. (максимальный момент: 2000мН).



| | | | | | |
|----------------|--------------------------------|--------|----------------|--------------------------------|--------|
| AISI 316 (V4A) | Tube Ø 60,3mm Tube Ø 2 3/8" | WP 281 | AISI 316 (V4A) | Tube Ø 60,3mm Tube Ø 2 3/8" | WP 290 |
|----------------|--------------------------------|--------|----------------|--------------------------------|--------|

FRANÇAIS : Platines de fixation lourdes.

DEUTSCH : Plattenhalter Schwere Ausführung.

ENGLISH : Heavy duty anchor bases.

NEDERLANDS : Vloer montageplaat (zware uitvoering).

ESPAÑOL : Pletinas de fijación macizas.

RUSSE : Крепежные наконечники, выносящие большие нагрузки.



FRANÇAIS : Caches-scellements.

DEUTSCH : Abdeckrosetten.

ENGLISH : Base collars.

NEDERLANDS : Bijpassende afdekrozet.

ESPAÑOL : Tapas embellecedoras.

RUSSE : Крепление опоры.

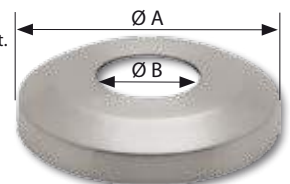

| Ø | AISI 304 (V2A) | AISI 316 (V4A) |
|--------------------------------|----------------|----------------|
| Ø 48x6mm / Ø 1 7/8" x 1/4" | W 50 | W 950 |
| Ø 75x6mm / Ø 2 15/16" x 1/4" | W 75 | W 975 |
| Ø 100x8mm / Ø 3 15/16" x 5/16" | W 100 | W 9100 |
| Ø 140x12mm / Ø 5 1/2" x 1/2" | - | W 9140 |

| Ø A | Ø B | AISI 304 (V2A) | AISI 316 (V4A) |
|----------------------|------------------------|----------------|----------------|
| Ø 58mm Ø 2 1/4" | Ø 16,5mm Ø 1/4" | W 60 | W 960 |
| Ø 80mm Ø 3 1/8" | Ø 42,7mm Ø 1 11/16" | W 80 | W 980 |
| Ø 110mm Ø 4 5/16" | Ø 42,7mm Ø 1 11/16" | W 110 | W 9110 |
| Ø 110mm Ø 4 5/16" | Ø 61mm Ø 2 3/8" | - | W 9115 |
| Ø 146mm Ø 5 1/2" | Ø 61mm Ø 2 3/8" | - | W 9145 |

SKYPORT

FRANÇAIS : Coudes à 90°. Fixation du tube par système à expansion.

DEUTSCH : 90° Winkeln. Rohrbefestigung durch Klemmsystem.

ENGLISH : 90° elbows. Pipe is secured by expansion sleeves.

NEDERLANDS : Klemverbindingsbochten 90° hoekverbindingsstuk.

ESPAÑOL : Codos con ángulo recto (90°). Fijación al tubo por expansión.

RUSSE : Панельный держатель для труб. Заглушки. Прессовая посадка.



| | | | |
|----------------|--------------------------------|---------------|-------------------------|
| AISI 316 (V4A) | Tube Ø 42,4mm Tube Ø 1,66" | WP 930 | A = 70 mm A = 2 3/4" |
| AISI 316 (V4A) | Tube Ø 60,3mm Tube Ø 2 3/8" | WP 230 | A = 90 mm A = 3 1/2" |

| | | |
|----------------|--------------------------------|---------------|
| AISI 316 (V4A) | Tube Ø 42,4mm Tube Ø 1,66" | WP 931 |
| AISI 316 (V4A) | Tube Ø 60,3mm Tube Ø 2 3/8" | WP 231 |

FRANÇAIS : Coude supérieur pour poteau à raccord pivotant. S'accorde à toute inclinaison de rampe. Livré avec vis de fixation M 8.

DEUTSCH : Obere Pfostenwinkel mit verdrehbarem Anschlußteil. Passend für alle Treppenneigungen. Geliefert mit M 8 Befestigungsschraube.

ENGLISH : Top elbow for post with swivel connection. Matches all offset angles. Delivered with an M 8 expansion screw.

NEDERLANDS : Hoekverbindingsstuk en instelbaar afstandstuk. Het verbindingss-
tuk aan de bovenzijde is passend voor elke hoek.

ESPAÑOL : Codo superior para balaustres: La unión superior es pivotante pudié-
ndose adaptar a cualquier inclinación de la barandilla. Se suministra con tornillo
de fijación M8.

RUSSE : Угловой соединитель для труб шарнирного соединения.
Подходит для всех углов. В комплект входит юстировочный винт M 8.



| | | |
|----------------|--------------------------------|---------------|
| AISI 304 (V2A) | Tube Ø 42,4mm Tube Ø 1,66" | WF 134 |
| AISI 316 (V4A) | Tube Ø 42,4mm Tube Ø 1,66" | WF 934 |
| AISI 316 (V4A) | Tube Ø 60,3mm Tube Ø 2 3/8" | WF 234 |

FRANÇAIS : Entretoise pivotante. Fixation des tubes par système à expansion.
Livrée avec vis de fixation M 8.

DEUTSCH : Distanzstück. Verdrehbar und passend für alle Neigungen. Befestigung
durch Klemmsystem. Geliefert mit M 8 Befestigungsschraube.

ENGLISH : Swivel spacer. Secured by expansion sleeves. Delivered with M 8 fixing
screws.

NEDERLANDS : Instelbaar afstandstuk voor elke hoek. Inclusief bevestigingss-
chroeven M8.

ESPAÑOL : Pieza de unión pivotante para dos tubos. Fijación al tubo por expansión. Se
suministran con tornillo de fijación M8.

RUSSE : Винтовая распорка. Оснащена раздвигающей втулкой. В комплект
входит крепежный винт M 8.



| | Ø A | Ø B | |
|----------------|----------------------|----------------------|---------------|
| AISI 304 (V2A) | Ø 42,4mm Ø 1,66" | Ø 42,4mm Ø 1,66" | WF 140 |
| AISI 316 (V4A) | Ø 42,4mm Ø 1,66" | Ø 42,4mm Ø 1,66" | WF 940 |
| AISI 316 (V4A) | Ø 60,3mm Ø 2 3/8" | Ø 60,3mm Ø 2 3/8" | WF 240 |
| AISI 316 (V4A) | Ø 60,3mm Ø 2 3/8" | Ø 42,4mm Ø 1,66" | WF 340 |

FRANÇAIS : Connexion articulée (48°/68°). Mise en œuvre aisée grâce au verrouillage
extérieur. Fixation des tubes par système à expansion. Livré avec vis de fixation M 8.

DEUTSCH : Gelenkverbindung (48°/68°). Einfache Benützung durch Außenblockier-
ung. Befestigung durch Klemmsystem. Geliefert mit M 8 Befestigungsschraube.

ENGLISH : Adjustable fitting (48°/68°). Easy to use due to the external locking.
Secured by expansion sleeves. Delivered with M 8 fixing screws.

NEDERLANDS : Verstelbaar hoekverbindingsstuk (48°/68°), eenvoudig bij mon-
tage door uitwendige blokkering. Inclusief bevestigingsschroeven M8.

ESPAÑOL : Conexión articulada (48°/68°). Facilidad de montaje gracias al atornillado
exterior. Fijación al tubo por expansión. Se suministran con tornillo de fijación M8.

RUSSE : Регулируемый штуцер (48°/68°). Легко используется при внешнем
креплении. Оснащен раздвигающей втулкой. В комплект входит крепежный винт
M 8

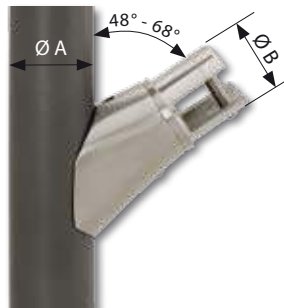

| | Ø A | Ø B | |
|----------------|----------------------|----------------------|---------------|
| AISI 304 (V2A) | Ø 42,4mm Ø 1,66" | Ø 42,4mm Ø 1,66" | WB 155 |
| AISI 316 (V4A) | Ø 42,4mm Ø 1,66" | Ø 42,4mm Ø 1,66" | WB 955 |
| AISI 316 (V4A) | Ø 60,3mm Ø 2 3/8" | Ø 60,3mm Ø 2 3/8" | WB 255 |
| AISI 316 (V4A) | Ø 60,3mm Ø 2 3/8" | Ø 42,4mm Ø 1,66" | WB 355 |

FRANÇAIS : Coudes réglables à verrouillage extérieur. Fixation du tube par système à expansion.

DEUTSCH : Verstellbare Winkel mit Außenblockierung. Rohrbefestigung durch Klemmsystem.

ENGLISH : Adjustable elbows with external locking. Pipe is secured by expansion sleeves.

NEDERLANDS : Verstelbaare hoekverbindingstuk met uitwendige blokkering.

ESPAÑOL : Codos regulables con apriete exterior. Fijación al tubo por expansión.

RUSSE : Регулируемые угловые соединители с внешним креплением. Труба оснащена раздвигающей втулкой



| | | |
|----------------|--------------------------------|---------------|
| AISI 316 (V4A) | Tube Ø 42,4mm Tube Ø 1,66" | WF 967 |
| AISI 316 (V4A) | Tube Ø 60,3mm Tube Ø 2 3/8" | WF 267 |

| | | |
|----------------|--------------------------------|---------------|
| AISI 316 (V4A) | Tube Ø 42,4mm Tube Ø 1,66" | WF 968 |
| AISI 316 (V4A) | Tube Ø 60,3mm Tube Ø 2 3/8" | WF 268 |

| | | |
|----------------|--------------------------------|---------------|
| AISI 316 (V4A) | Tube Ø 42,4mm Tube Ø 1,66" | WF 969 |
| AISI 316 (V4A) | Tube Ø 60,3mm Tube Ø 2 3/8" | WF 269 |

FRANÇAIS : Raccords latéraux. Fixation du tube par système à expansion. Livrés avec vis de fixation M 8.

DEUTSCH : Querverbinder. Rohrbefestigung durch Klemmsystem. Geliefert mit M 8 Befestigungsschraube.

ENGLISH : Lateral fittings. Tube is secured by means of integral expansion sleeve. Delivered with M 8 fixing screw.

NEDERLANDS : Hoekverbindingstukken, inclusief bevestigingsschroeven M8.

ESPAÑOL : Piezas de unión lateral. Fijación con sistema de expansión. Equipado con tornillo de fijación M8.

RUSSE : Боковые соединительные детали. Труба защищена внутренней раздвигающей втулкой. В комплект входит крепежный болт M 8.



| | Ø A | Ø B | |
|----------------|----------------------|----------------------|---------------|
| AISI 304 (V2A) | Ø 42,4mm Ø 1,66" | Ø 42,4mm Ø 1,66" | WF 133 |
| AISI 316 (V4A) | Ø 42,4mm Ø 1,66" | Ø 42,4mm Ø 1,66" | WF 933 |
| AISI 316 (V4A) | Ø 60,3mm Ø 2 3/8" | Ø 60,3mm Ø 2 3/8" | WF 233 |

| | Ø A | Ø B | |
|----------------|----------------------|----------------------|---------------|
| AISI 304 (V2A) | Ø 42,4mm Ø 1,66" | Ø 42,4mm Ø 1,66" | WF 132 |
| AISI 316 (V4A) | Ø 42,4mm Ø 1,66" | Ø 42,4mm Ø 1,66" | WF 932 |
| AISI 316 (V4A) | Ø 60,3mm Ø 2 3/8" | Ø 60,3mm Ø 2 3/8" | WF 232 |
| AISI 316 (V4A) | Ø 60,3mm Ø 2 3/8" | Ø 42,4mm Ø 1,66" | WF 332 |

FRANÇAIS : Supports muraux, fixe et réglables à verrouillage extérieur. Fixation du tube par système à expansion.

DEUTSCH : Wandflansche, fest und verstellbar mit Außenblockierung. Rohrbefestigung durch Klemmsystem.

ENGLISH : Wall flanges: fixed and adjustable with external locking.

NEDERLANDS : Vaste en verstelbare wandbevestiging.

ESPAÑOL : Soportes para muro, fijo y regulable con atornillado exterior. Fijación al tubo por expansión.

RUSSE : Пристенные фланцы: хорошо подходят для внешнего крепления.

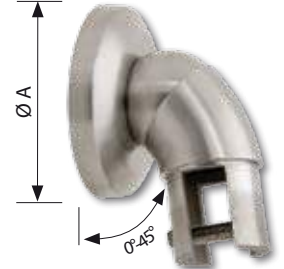
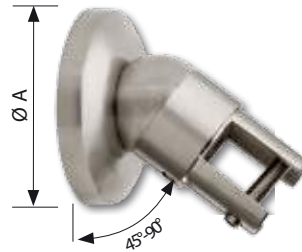
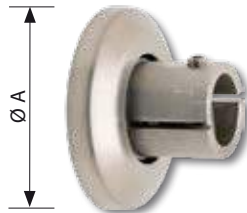

| | | |
|----------------|--------------------------------|---------------|
| AISI 304 (V2A) | Tube Ø 42,4mm Tube Ø 1,66" | WP 182 |
| AISI 316 (V4A) | Tube Ø 42,4mm Tube Ø 1,66" | WP 982 |
| AISI 316 (V4A) | Tube Ø 60,3mm Tube Ø 2 3/8" | WP 282 |

| | | |
|----------------|--------------------------------|---------------|
| AISI 304 (V2A) | Tube Ø 42,4mm Tube Ø 1,66" | WP 178 |
| AISI 316 (V4A) | Tube Ø 42,4mm Tube Ø 1,66" | WP 978 |
| AISI 316 (V4A) | Tube Ø 60,3mm Tube Ø 2 3/8" | WP 278 |

| | | |
|----------------|--------------------------------|---------------|
| AISI 304 (V2A) | Tube Ø 42,4mm Tube Ø 1,66" | WP 179 |
| AISI 316 (V4A) | Tube Ø 42,4mm Tube Ø 1,66" | WP 979 |
| AISI 316 (V4A) | Tube Ø 60,3mm Tube Ø 2 3/8" | WP 279 |

FRANÇAIS : Boules équipées d'un trou taraudé. Finition émerisée au grade 320.

DEUTSCH : Kugeln mit Innengewinde. Korn 320 geschliffen.

ENGLISH : Balls equipped with a threaded hole. Grade 320 grit finish.

NEDERLANDS : Bollen met draadbus.

ESPAÑOL : Bolas equipadas con taladro roscado. Acabado esmerilado con grano 320.

RUSSE : Шаровой шарнир оснащен отверстием с резьбой. Обработка поверхности - степень 320.

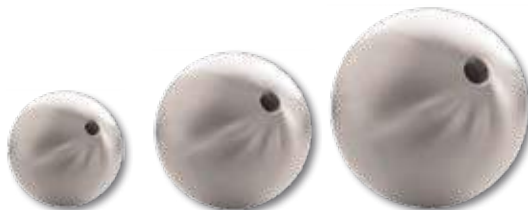

| | Ø | AISI 304 (V2A) | AISI 316 (V4A) | M |
|---|---------------------|----------------|----------------|----|
| Boules massives Vollkugeln Solid balls Massieve bollen Bolas macizas Цельные шарниры | Ø 20mm Ø 2 3/8" | WK 20 | WK 920 | M6 |
| | Ø 25mm Ø 1" | WK 25 | WK 925 | M6 |
| | Ø 30mm Ø 1 3/16" | WK 30 | WK 930 | M6 |

| | Ø | AISI 304 (V2A) | AISI 316 (V4A) | M |
|--|-----------------------|----------------|----------------|-----|
| Boules creuses Hohlkugeln Hollow balls Holle bolen Bolas huecas Полые шарниры | Ø 40mm Ø 1 9/16" | WK 40 | WK 940 | M8 |
| | Ø 50mm Ø 2" | WK 50 | WK 950 | M8 |
| | Ø 60mm Ø 2 3/8" | WK 60 | WK 960 | M8 |
| | Ø 80mm Ø 3 1/8" | WK 80 | WK 980 | M10 |
| | Ø 100mm Ø 3 15/16" | WK 100 | WK 9100 | M10 |
| | Ø 120mm Ø 4 3/4" | WK 120 | WK 9120 | M10 |

SKYPORT

FRANÇAIS : Supports de traverse borgnes ou débouchants. Blocage par vis de pression. Livré avec vis de fixation M 6.

DEUTSCH : Verstellbare Traversenhalter. Mit Sack oder durchgehender Bohrung. Blockierung durch Druckschrauben. Geliefert mit M 6 Befestigungsschraube.

ENGLISH : Adjustable cross bar brackets with recessed or crossing hole. Locking by blocking screws. Delivered with M 6 fixing screw.

NEDERLANDS : Verstelbare kruis-verbindingstukken als einden doorvoerstuk. Inclusief bevestigingsschroeven M6.

ESPAÑOL : Soportes ciegos o pasantes para traviesas centrales de barandilla. Bloqueo con tornillo de presión.

RUSSE : Регулируемая крестообразная подпорка с глухим или поперечным отверстием. Завершается блокирующим болтом. В комплект входит крепежный болт М 6.

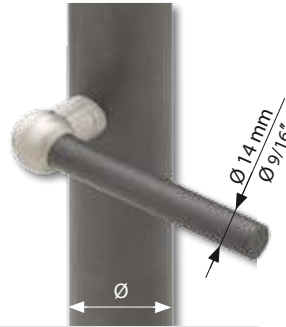

| | | |
|----------------|--------------------------------|---------------|
| AISI 304 (V2A) | Tube Ø 42,4mm Tube Ø 1,66" | WB 145 |
| AISI 316 (V4A) | Tube Ø 42,4mm Tube Ø 1,66" | WB 945 |
| AISI 316 (V4A) | Tube Ø 60,3mm Tube Ø 2 3/8" | WB 245 |

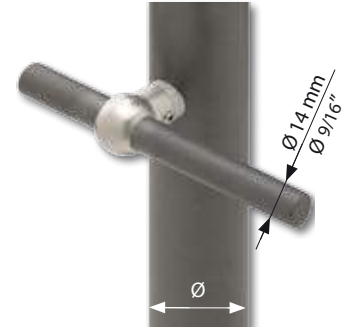

| | | |
|----------------|--------------------------------|---------------|
| AISI 304 (V2A) | Tube Ø 42,4mm Tube Ø 1,66" | WB 146 |
| AISI 316 (V4A) | Tube Ø 42,4mm Tube Ø 1,66" | WB 946 |
| AISI 316 (V4A) | Tube Ø 60,3mm Tube Ø 2 3/8" | WB 246 |



| | | |
|----------------|--------------------------------|---------------|
| AISI 304 (V2A) | Tube Ø 42,4mm Tube Ø 1,66" | WB 165 |
| AISI 316 (V4A) | Tube Ø 42,4mm Tube Ø 1,66" | WB 965 |
| AISI 316 (V4A) | Tube Ø 60,3mm Tube Ø 2 3/8" | WB 265 |



| | | |
|----------------|--------------------------------|---------------|
| AISI 304 (V2A) | Tube Ø 42,4mm Tube Ø 1,66" | WB 160 |
| AISI 316 (V4A) | Tube Ø 42,4mm Tube Ø 1,66" | WB 960 |
| AISI 316 (V4A) | Tube Ø 60,3mm Tube Ø 2 3/8" | WB 260 |



| | | |
|----------------|--------------------------------|---------------|
| AISI 304 (V2A) | Tube Ø 42,4mm Tube Ø 1,66" | WB 180 |
| AISI 316 (V4A) | Tube Ø 42,4mm Tube Ø 1,66" | WB 980 |
| AISI 316 (V4A) | Tube Ø 60,3mm Tube Ø 2 3/8" | WB 280 |

FRANÇAIS : Supports de balustres borgnes ou débouchants. Blocage par vis de pression M 6.

DEUTSCH : Verstellbare Stabhalter. Mit Sack oder durchgehender Bohrung. Blockierung durch M6 Druckschrauben.

ENGLISH : Adjustable baluster holders with recessed or crossing hole. Locking by blocking M6 screws.

NEDERLANDS : Verstelbare spijlhouders voor spijlen Ø 16 mm als einden M6 doorvoerstuk.

ESPAÑOL : Soportes ciegos o pasantes para balaustres. Bloqueo con tornillo M6 de presión.

RUSSE : Регулируемые держатели стойки с глухим или поперечным отверстием. Фиксируется при помощи крепежных болтов М6.

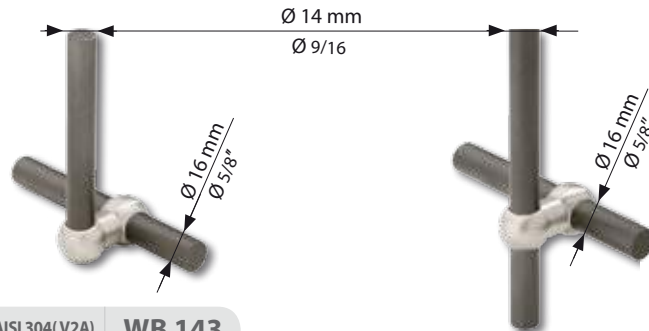

| | |
|----------------|---------------|
| AISI 304 (V2A) | WB 143 |
| AISI 316 (V4A) | WB 943 |

| | |
|----------------|---------------|
| AISI 304 (V2A) | WB 144 |
| AISI 316 (V4A) | WB 944 |

FRANÇAIS : Embouts décoratifs de terminaison de barres, équipés d'un trou taraudé M 6.

DEUTSCH : Endstücke für Stangen mit M 6 Innengewinde.

ENGLISH : Decorative bar endpieces with an M 6 threaded hole.

NEDERLANDS : Decoratief eindstuk met draadbus M6.

ESPAÑOL : Extremos decorativos para final de barras, equipados con taladro roscado M6.

RUSSE : Декоративные заглушки на стержни с резьбовым отверстием М 6.

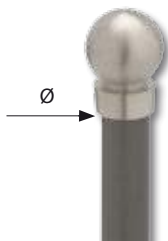

| Ø | AISI 304 (V2A) | AISI 316 (V4A) |
|--------------------|----------------|----------------|
| Ø 14mm Ø 9/16" | WE 14 | WE 914 |
| Ø 16mm Ø 5/8" | WE 16 | WE 916 |
| Ø 18mm Ø 11/16" | WE 18 | WE 918 |

FRANÇAIS : Ecrus à river aveugles en acier inoxydable (sachets de 50 pièces).

DEUTSCH : V 2 A Blindnietmuttern (50 Stück pro Pack)

ENGLISH : SS blind rivet nut (50 pees per bag)

NEDERLANDS : RVS blindnietmoer (eenheidsverpakking 50 st)

ESPAÑOL : Tuerca para remache ciego en acero inoxidable. Disponible en bolsas de 50 unidades.

RUSSE : Односторонняя заклепочная гайка из нержавеющей стали (50 шт в упаковке)



| M | AISI 304 (V2A) |
|-----|----------------|
| M5 | WR 5 |
| M6 | WR 6 |
| M8 | WR 8 |
| M10 | WR 10 |

FRANÇAIS : Accessoires de montage pour câble Ø 5 mm (WB 905).

DEUTSCH : Montagezubehör für Drahtseil Ø 5 mm (WB 905).

ENGLISH : Accessories for assembling cable Ø 5 mm (WB 905).

NEDERLANDS : Accessoires voor assemblage van de kabel Ø 5 mm (WB 905).

ESPAÑOL : Accesorios para el montaje del cable Ø 5 mm (WB 905).

RUSSE : Вспомогательное оборудование для монтажа витого орнамента Ø 5 мм (WB 905).

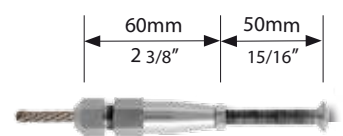
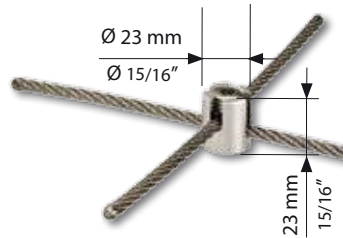
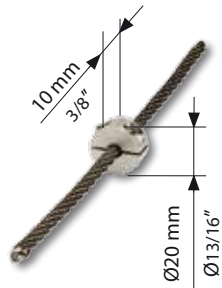

| | |
|----------------|--------------|
| AISI 304 (V2A) | WO 5 |
| AISI 316 (V4A) | WO 95 |

| | |
|----------------|--------------|
| AISI 304 (V2A) | WX 5 |
| AISI 316 (V4A) | WX 95 |

| | |
|----------------|---------------|
| AISI 316 (V4A) | WB 915 |
|----------------|---------------|

FRANÇAIS : Supports orientables de câble d'extrémités et intermédiaires. Le support d'extrémité assure la fixation du câble par pincement ainsi que la fonction de tendeur. Blocage par vis de pression. Livré avec vis de fixation M 6.

DEUTSCH : Verstellbarer End und Zwischendrahtseilhalter. Der Endhalter stellt die Seilklemmung sicher und nimmt auch die Spannung auf. Blockierung durch Druckschrauben. Geliefert mit M 6 Befestigungsschraube.

ENGLISH : Adjustable terminal or intermediate cable holder. The terminal fastener ensures a positive stop and also can be utilized to tighten the assembly. Locking by blocking screw. Delivered with M 6 fixing screws.

NEDERLANDS : Verstelbaar eind- en doorvoerstuk voor Stainless Steel kabel. De eindstuk zorgt voor de kabel blokkering en werkt als zekerheid door blokkeringschroef.

ESPAÑOL : Soportes orientables, de extremo e intermedio, para cable. Los soportes de extremo, aseguran la fijación del cable por pinzamiento a la vez que realizan la función de tensor. Bloqueo con tornillo de presión. Se suministra con tornillo de fijación M6.

RUSSE : Регулируемый конечный или промежуточный держатель витого орнамента. Промежуточная крепежная деталь гарантирует жесткий упор, а также может быть использована для закрепления конструкции. Завершается крепежным болтом. В комплект входит крепежный болт M 6.

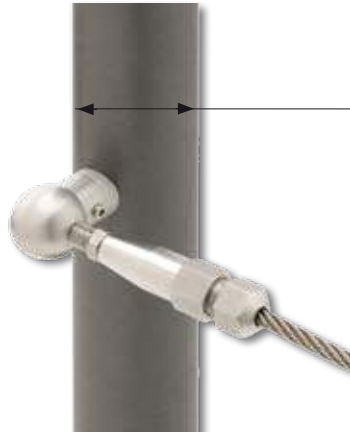

| | | |
|----------------|--------------------------------|----------------|
| AISI 316 (V4A) | Tube Ø 42,4mm Tube Ø 1,66" | WB 900 |
| AISI 316 (V4A) | Tube Ø 60,3mm Tube Ø 2 3/8" | WB 2900 |

| | | |
|----------------|--------------------------------|----------------|
| AISI 304 (V2A) | Tube Ø 42,4mm Tube Ø 1,66" | WB 810 |
| AISI 316 (V4A) | Tube Ø 42,4mm Tube Ø 1,66" | WB 910 |
| AISI 316 (V4A) | Tube Ø 60,3mm Tube Ø 2 3/8" | WB 2910 |

Support fermé
End post
Handlauf Halter
Geschlossen
Soporte ciego
Концевая стойка



| | | |
|----------------|-------------------------------|---------------|
| AISI 304 (V2A) | Tube Ø 42,4mm Tube Ø 1,66" | WS 169 |
| AISI 316 (V4A) | Tube Ø 42,4mm Tube Ø 1,66" | WS 969 |

Support traversant
Center post
Handlauf Halter
Durchgehend
Soporte transversal
Средняя стойка



| | | |
|----------------|-------------------------------|---------------|
| AISI 304 (V2A) | Tube Ø 42,4mm Tube Ø 1,66" | WS 171 |
| AISI 316 (V4A) | Tube Ø 42,4mm Tube Ø 1,66" | WS 971 |

FRANÇAIS : Câble INOX Ø 5 vendu en rouleaux de 25 ml.

DEUTSCH : Drahtseil V4 A Ø 5 mm in 25 lfm-Rollen erhältlich.

ENGLISH : SS cable Ø 5 sold in 25 ml rolls.

NEDERLANDS : Kabel is Stainless Steel met een doorsnede van 5 mm en leverbaar in rollen van 25 m.

ESPAÑOL : El cable de INOX de Ø 5, se suministra en rollos de 25 ml.

RUSSE : Витой орнамент из нержавеющей стали Ø 5, продающийся в комплектах по 25 мл.



| | |
|----------------|---------------|
| AISI 316 (V4A) | WB 905 |
|----------------|---------------|



| | | |
|----------------|-------------------------------|---------------|
| AISI 316 (V4A) | Tube Ø 42,4mm Tube Ø 1,66" | WS 987 |
|----------------|-------------------------------|---------------|

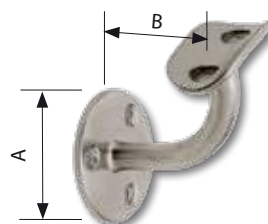

| | Ø | A | B | |
|----------------|----------------------|----------------|----------------|---------------|
| AISI 304 (V2A) | Ø 42,4mm Ø 1,66" | 60mm 2 3/8" | 70mm 2 3/4" | WS 172 |
| AISI 316 (V4A) | Ø 42,4mm Ø 1,66" | 60mm 2 3/8" | 70mm 2 3/4" | WS 972 |
| AISI 316 (V4A) | Ø 60,3mm Ø 2 3/8" | 80mm 3 1/8" | 90mm 3 1/2" | WS 272 |

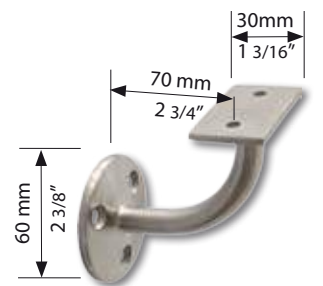

| | |
|----------------|--------------------|
| AISI 304 (V2A) | WS 172 FLAT |
|----------------|--------------------|

SKYPORT

Poncé au grain 320 - Korn 320 geschliffen - Grade 320 grit finish - Esmerilado con grano 320
Обработка поверхности - степень 320

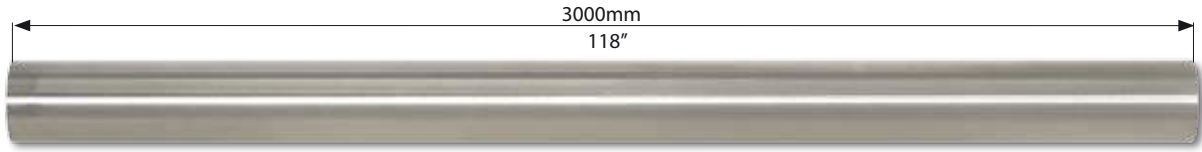

| | | |
|----------------|--------------------------------|---------------|
| AISI 304 (V2A) | Tube Ø 42,4mm Tube Ø 1,66" | WT 422 |
| AISI 316 (V4A) | Tube Ø 42,4mm Tube Ø 1,66" | WT 922 |
| AISI 316 (V4A) | Tube Ø 60,3mm Tube Ø 2 3/8" | WT 222 |

Barres pleines - Vollmaterial - Solid bars - Massiefmateriaal - Barras macizas
Цельные стержни



| | | |
|----------------|--------------------|--------------|
| AISI 304 (V2A) | Ø 14mm Ø 9/16" | WT 14 |
| AISI 304 (V2A) | Ø 16mm Ø 5/8" | WT 16 |
| AISI 304 (V2A) | Ø 18mm Ø 11/16" | WT 18 |

| | | |
|----------------|--------------------|---------------|
| AISI 316 (V4A) | Ø 14mm Ø 9/16" | WT 914 |
| AISI 316 (V4A) | Ø 16mm Ø 5/8" | WT 916 |
| AISI 316 (V4A) | Ø 18mm Ø 11/16" | WT 918 |

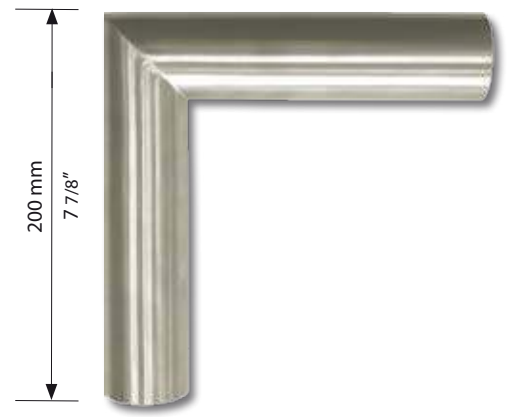
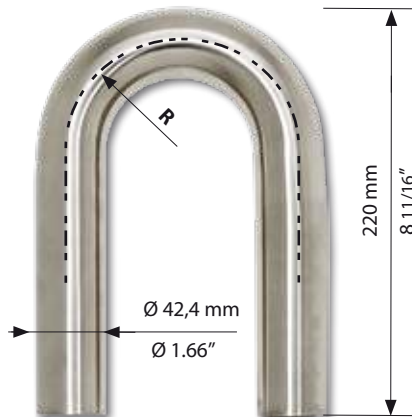
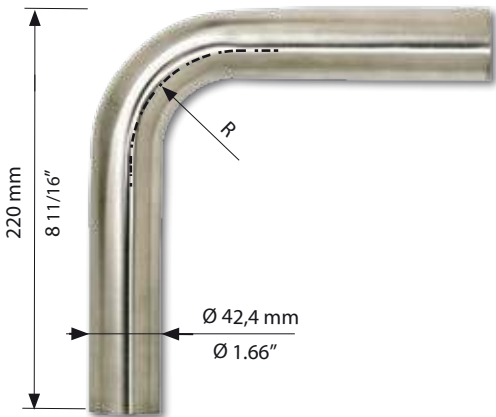

| R | AISI 304 (V2A) | AISI 316 (V4A) |
|-------------------------|----------------|----------------|
| R=64mm R = 2 1/2" | WC 64 | WC 964 |
| R=85mm R = 3 3/8" | WC 85 | WC 985 |
| R=100mm R = 3 15/16" | WC 100 | WC 9100 |

| R | AISI 304 (V2A) | AISI 316 (V4A) |
|-------------------------|----------------|----------------|
| R=64mm R = 2 1/2" | WU 64 | WU 964 |
| R=85mm R = 3 3/8" | WU 85 | WU 985 |
| R=100mm R = 3 15/16" | WU 100 | WU 9100 |

| | | |
|----------------|--------------------------------|---------------|
| AISI 316 (V4A) | Tube Ø 60,3mm Tube Ø 2 3/8" | WC 200 |
|----------------|--------------------------------|---------------|

Jonction pour tube
Pipe connector
Rohrverbinder
Pieza de union



| | | |
|----------------|--------------------------------|---------------|
| AISI 304 (V2A) | Tube Ø 42,4mm Tube Ø 1,66" | WF 166 |
| AISI 316 (V4A) | Tube Ø 42,4mm Tube Ø 1,66" | WF 966 |
| AISI 316 (V4A) | Tube Ø 60,3mm Tube Ø 2 3/8" | WF 266 |

FRANÇAIS : Gabarit de perçage. Ce coffret comprend les éléments indispensables pour réaliser les perçages nécessaires au montage, en garantissant leur alignement et position de façon rigoureuse.

DEUTSCH : Bohrschablone. In dieser Box finden Sie das Zubehör, um problemlos die notwendigen Bohrungen vorzunehmen.

ENGLISH : Drilling template. This presentation box comprises the components indispensable to make the necessary drillings for the assembly, by guaranteeing rigorously their alignment and position.

NEDERLANDS : Boorsjabloon. Deze kit bevat onmisbare hulpmiddelen om de nodige boringen te maken voor een juiste positionering en assemblage.

ESPAÑOL : Útil para taladrar. Esta caja comprende los elementos indispensables para realizar los taladros necesarios en el montaje, garantizando su alineamiento y posición de forma rigurosa.

RUSSE : Набор образцов для сверления. Этот презентационный набор сочетает в себе компоненты, которые используются для того чтобы просверлить необходимые для монтажа отверстия, гарантируя точную регулировку и расположение.



| | |
|--------------------------------|--------------|
| Tube Ø 42,4mm Tube Ø 1,66" | WJ 10 |
| Tube Ø 60,3mm Tube Ø 2 3/8" | WJ 20 |

| | | | |
|----------------|--------------------------------|--------------|--------------|
| AISI 304 (V2A) | Tube Ø 42,4mm Tube Ø 1,66" | W 170 | W 168 |
| AISI 316 (V4A) | Tube Ø 42,4mm Tube Ø 1,66" | W 970 | W 968 |
| AISI 316 (V4A) | Tube Ø 60,3mm Tube Ø 2 3/8" | W 270 | W 268 |



FRANÇAIS : Manchons décoratifs. Ils sont équipés d'une vis de blocage M 3 permettant un montage facile et rapide.

DEUTSCH : Zierhülsen, ausgerüstet mit einer M 3 Blockierschraube für einfache und rasche Montage.

ENGLISH : Decorative sleeves equipped with an M 3 locking screw to allow a fast and easy mounting.

NEDERLANDS : Sierhulzen voorzien van een M 3 blokkeringschroefje voor eenvoudige en snelle montage.

ESPAÑOL : Macolla decorativa equipada con tornillo de bloqueo M 3 para un montaje impecable y rápido.

RUSSE : Отделочная втулка с крепежным болтом М 3, позволяет быстрый и легкий монтаж.



| | |
|----------------|---------------|
| AISI 304 (V2A) | WM 34 |
| AISI 316 (V4A) | WM 934 |

| | |
|----------------|----------------|
| AISI 304 (V2A) | WM 124 |
| AISI 316 (V4A) | WM 9124 |

| | |
|----------------|---------------|
| AISI 304 (V2A) | WM 54 |
| AISI 316 (V4A) | WM 954 |

FRANÇAIS : Pinces de fixation à base plane ou pour tube. Elles sont équipées d'une goupille de sécurité Ø 6 mm et de cales PUR pour plaques de verre d'épaisseur 7 à 13,52 mm. Livrées avec vis de fixation M 6.

DEUTSCH : Glashalter mit Flansch oder für Basis. Ausgerüstet mit einem Ø 6 mm Sicherheitsstift und mit PUR Einlagen für 7 bis 13,52 mm Glasdicke. Geliefert mit M 6 Befestigungsschraube.

ENGLISH : Glassclips with flat or for pipe base. Equipped with a Ø 6 mm security pin and PUR wedge for 7 mm to 13,52 mm glass thickness. Delivered with an M 6 fixing screw.

NEDERLANDS : Glasklemmen voor bevestiging op wand of buis met een doorsnede. Geleverd met veiligheidsstift, Ø 6 mm en bevestigingschroef M 6. Klemmen voor glas met een dikte van 7 tot 13,52 mm, inclusief kunststof bescherming.

ESPAÑOL : Pinzas de fijación a base plana y a tubo. Equipadas con tetón de seguridad de Ø 6 mm. y calces de poliuretano para cristal de 7 a 13,52 mm. de espesor. Se suministran con tornillo de fijación M6.

RUSSE : Держатели стекла для ровной поверхности или круглой трубы. Оснащены защитным болтом размером в Ø 6 мм и полиуретановым клином для стекла толщиной от 7 мм до 13,52 мм. В комплект также входит крепежный винт М 6.



| | AISI 316 (V4A) | AISI 316 (V4A) | AISI 316 (V4A) | AISI 316 (V4A) | AISI 316 (V4A) | AISI 316 (V4A) | AISI 316 (V4A) | AISI 316 (V4A) |
|---------------------------------|----------------------------|----------------------------|----------------------------|----------------------------|-----------------------------|-----------------------------|-----------------------------|-----------------------------|
| | WG 974 | WG 994 | WG 975 | WG 995 | WG 274 | WG 294 | WG 275 | WG 295 |
| Modèle Shape | ③ | ③ | ④ | ④ | ③ | ③ | ④ | ④ |
| Type de tube Tube type | Tube Ø 42,4mm Tube Ø 1,66" | Tube Ø 42,4mm Tube Ø 1,66" | Tube Ø 42,4mm Tube Ø 1,66" | Tube Ø 42,4mm Tube Ø 1,66" | Tube Ø 60,3mm Tube Ø 2 3/8" | Tube Ø 60,3mm Tube Ø 2 3/8" | Tube Ø 60,3mm Tube Ø 2 3/8" | Tube Ø 60,3mm Tube Ø 2 3/8" |
| Épaisseur verre Glass thickness | 7 - 10 mm | 10.7 - 13.5 mm | 7 - 10 mm | 10.7 - 13.5 mm | 7 - 10 mm | 10.7 - 13.5 mm | 7 - 10 mm | 10.7 - 13.5 mm |

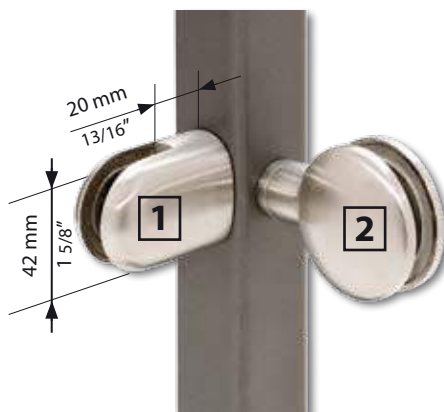

FRANÇAIS : Supports de panneau pour tube.

DEUTSCH : Platte Halter für Rohren.

ENGLISH : Panel holder for pipes.

NEDERLANDS : Paneelhouder voor montage op buis.

ESPAÑOL : Soporte de panel para tubos.



| | AISI 316 (V4A) | AISI 316 (V4A) | AISI 316 (V4A) | AISI 316 (V4A) |
|---------------------------------|----------------|----------------|----------------|----------------|
| | WG 973 | WG 993 | WG 977 | WG 997 |
| Modèle Shape | ① | ① | ② | ② |
| Type de tube Tube type | ☑ | ☑ | ☑ | ☑ |
| Épaisseur verre Glass thickness | 7 - 10 mm | 10.7 - 13.5 mm | 7 - 10 mm | 10.7 - 13.5 mm |

| | | |
|----------------|-----------------------------|----------------|
| AISI 316 (V4A) | Tube Ø 42,4mm Tube Ø 1,66" | WB 900 |
| AISI 316 (V4A) | Tube Ø 60,3mm Tube Ø 2 3/8" | WB 2900 |

SKYPORT

FRANÇAIS : Poignées de porte en acier inoxydable AISI304 (DIN 4301) simples ou doubles. Livrées avec les éléments nécessaires au montage sur portes en verre ou autre d'une épaisseur comprise entre 10 et 70 mm. Les supports sont réalisés en deux finitions différentes : finement émerisés au grain de 400 (page 9) ou poli brillant puis revêtu TIN (nitru de titane) pour un aspect doré, pratiquement inaltérable.

DEUTSCH : Stoßgriffe aus V2A Edelstahl (Werkstoff 4301), geliefert mit den zur Montage nötigen Bestandteilen für Materialstärken von 10 mm-70 mm. Die Träger sind in zweierschiedenen Oberflächen lieferbar : geschliffen Korn 400 oder TIN (Titan Nitrad) glanzvergoldet-hochglanzpoliert dauerhafter Goldglanz.

ENGLISH : Single or double Stainless Steel TYPE 304 (DIN4301) door handles. Supplied with all the components necessary for assembly on glass doors or else between 0.4" and 2.75" (10 to 70 mm) thick. The brackets are available in two different finishes : either finely-grained with a 400 grain emery-cloth or polished shiny and TIN (titanium nitride) covered for a virtually unalterable gilded look.

NEEDERLANDS : Deurgrepen RVS/Inox V2A, AISI 304 (DIN4301), per stuk of per paar. Leverbaar met bevestigingsmateriaal voor glazen of andere deuren met dikte variërend tussen 10 en 70mm. De verbindingstukken zijn leverbaar in twee uitvoeringen: geslepen met korrel 400 of hoogglans gepolijst voorzien van TIN (titanium nitride) voor een duurzame goudglans.

ESPAÑOL : Empuñaduras de puerta en acero inoxidable AISI304 (DIN 4301) simples o dobles. Suministrados con los elementos necesarios para el montaje en puertas de cristal u otros de un grosor comprendido entre los 10 y 70 mm. Los soportes están realizados con dos acabados distintos: finamente esmerilados con grano 400 (Página 9) o pulidos brillantes, revestidos después con TIN (Nitruro de Titanio) para un aspecto dorado prácticamente inalterable.

RUSSE : Ручки для однополюных и двухполюных дверей из нержавеющей стали 304 (DIN4301).
Поставляются со всеми необходимыми компонентами для монтажа стеклянных дверей или других конструкций толщиной между 0.4" и 2.75" (с 10 до 70 мм).
Держатели доступны в 2 разных видах обработки, а именно: мелкозернистые с 400-зернистым наждачным покрытием или полированные и покрытые нитридом титана для практически неизменного позолоченного вида.

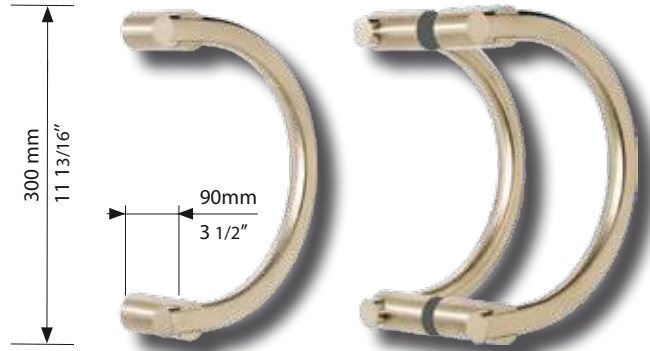

WH411

WH 412

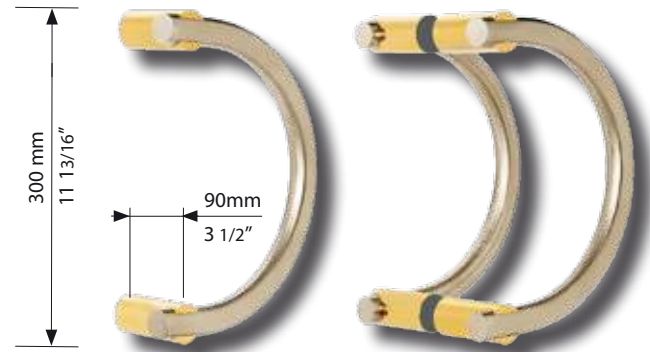

WH 421

WH 422

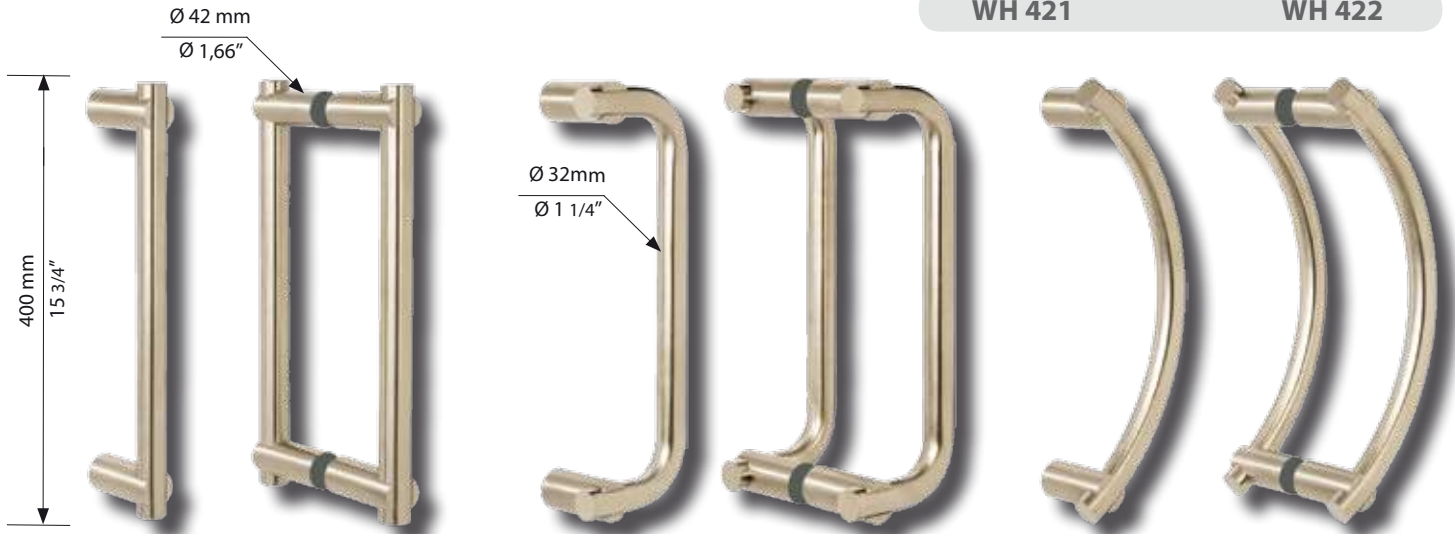

WH 111

WH112

WH311

WH 312

WH 211

WH 212

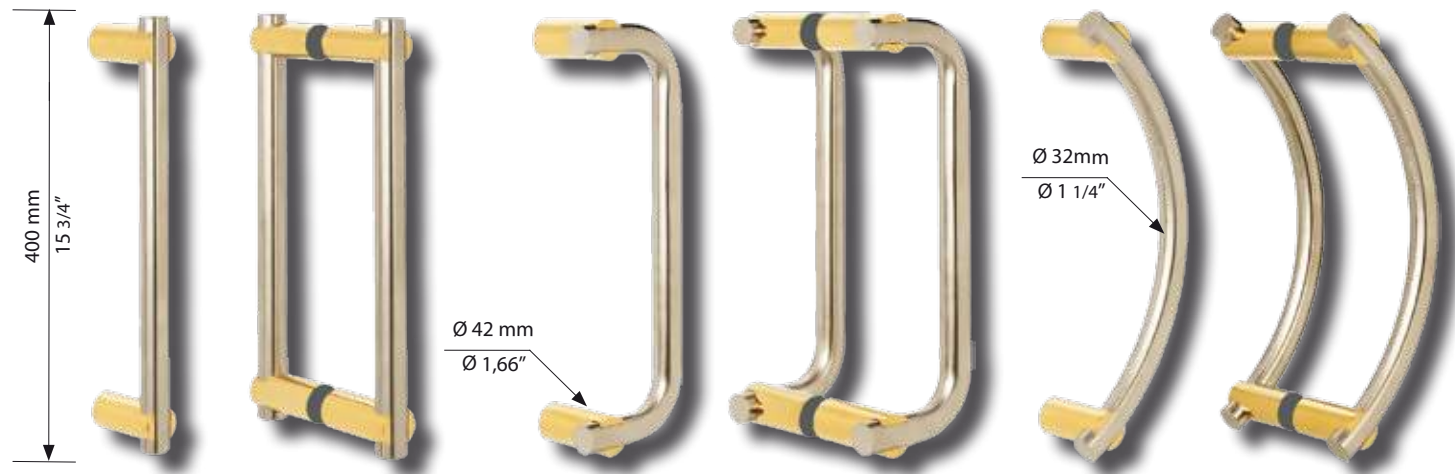

WH 121

WH 122

WH 321

WH 322

WH 221

WH 222

MAINS COURANTES PRÊTES A POSER
READY TO INSTALL HANDRAIL
EINBAUFERTIGER HANDLAUF
LEUNINGEN KLAAR OM OP TE HANGEN
BARANDILLA LISTA PARA INSTALAR
ГОТОВЫЕ К УСТАНОВКЕ ПОРУЧНИ

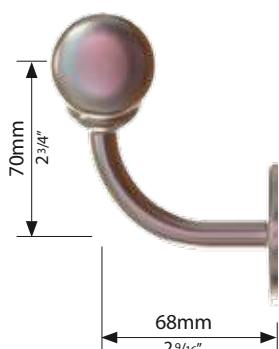
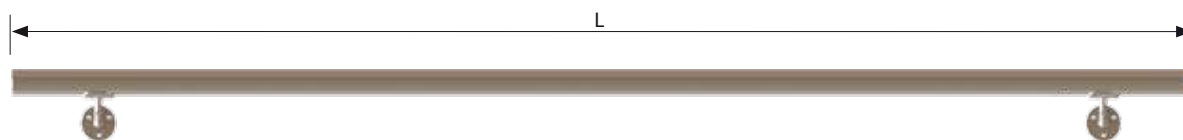

INOX 304

INOX



Longueur 1000 mm
Lengths 39 3/8"

MC-W1-1000



Longueur 1500 mm
Lengths 58 5/8"

MC-W1-1500



Longueur 2000 mm
Lengths 78"

MC-W1-2000



Longueur 3000 mm
Lengths 10 ft.

MC-W1-3000



INOX 316



500 ml CLEANER



Longueur 1000 mm
Lengths 39 3/8"

MC-W91-1000



Longueur 1500 mm
Lengths 58 5/8"

MC-W91-1500



Longueur 2000 mm
Lengths 78"

MC-W91-2000



Longueur 3000 mm
Lengths 10 ft.

MC-W91-3000



CARBONE

CARBONE

FRANÇAIS : La forte tendance à l'individualisation que l'on observe en aménagement intérieur, nous a incité à développer cette collection. Les barreaux sont réalisés manuellement en FIBRE DE CARBONE. Ils sont montés au choix avec des embouts en acier, carrés (K), ronds (R) ou rond inox (W). L'accent est mis sur les couleurs ce qui ajoute de la flexibilité au concept. Usage exclusive en intérieur.

ENGLISH : The strong trend towards individualization that we observe in interior design, prompted us to develop this collection. Balusters are hand made in CARBON FIBER. They are assembled with endpieces in steel, square (K) round (R) or round stainless steel endpieces (W). The focus is on the colors, which adds flexibility to the concept. These items are for interior use only.

DEUTSCH : Der starke Trend zur Individualisierung, den wir bei der Inneneinrichtung beobachten, veranlasste uns, diese Kollektion zu entwickeln. Die Baluster sind handgefertigt aus KARBONFASER. Sie werden mit Endstücken aus Stahl, Viereck (K) oder Rund (R) oder runden Edstahlestücken (W) montiert. Der Fokus liegt auf den Farben, die dem Konzept Flexibilität verleihen. Diese Artikel sind nur für den Innenbereich bestimmt.

NEDERLANDS : De sterke trend naar individualisering die we waarnemen bij het interieurontwerp, heeft ons ertoe aangezet deze collectie te ontwikkelen. Balusters worden met de hand gemaakt in CARBON FIBER. Ze worden geassembleerd met eindplaten in staal, vierkant (K) of rond (R) of rond roestvrijstalen eindstukken (W). De focus ligt op de kleuren, wat flexibiliteit aan het concept toevoegt. Deze artikelen zijn alleen voor gebruik binnenshuis.

ESPAÑOL : La fuerte tendencia hacia la individualización que observamos en el diseño de interiores, nos llevó a desarrollar esta colección. Los balaustres están hechos a mano en FIBRA DE CARBONO. Se ensamblan con terminales en acero, cuadrado (K) o redondo (R) o redondo terminales de acero inoxidable (W). La atención se centra en los colores, lo que agrega flexibilidad al concepto. Estos artículos son solo para uso interior.

RUSSE : Сильная тенденция к индивидуализации, которую мы наблюдаем в дизайне интерьера, побудила нас развивать эту коллекцию. Балясины сделаны вручную из УГЛЕРОДНОГО ВОЛОКНА. Они собираются из концевых наконечников из стали, квадратного (K) или круглого (R) и изогнутых наконечников из нержавеющей стали (W). Основное внимание уделяется цветам, что добавляет концепции гибкости. Эти предметы предназначены только для внутреннего использования.



CARBONE RED

ø 90mm
H: 140mm

ø 3 1/2"
H: 5 1/2"



TCARB-RED



TBL90-RED

ø 100mm
H: 140mm

ø 4"
H: 5 1/2"



TBL70-RED

ø 54mm
ø 2 1/8"



| | | |
|-----------------------|-------------------------|-----------|
| ● 16 mm 5/8" | Ø = 63mm Ø = 2 1/2" | CSR16-RED |
| ● 40 mm 1 5/8" | Ø = 120mm Ø = 4 3/4" | CSR40-RED |
| ● 42.4 mm 1 11/16" | Ø = 80mm Ø = 1 1/8" | CSR42-RED |

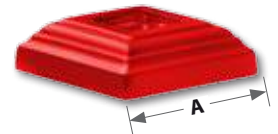

| | | |
|-------------------|------------------------|-----------|
| ■ 16 mm 5/8" | A = 60mm A = 2 3/8" | CSK16-RED |
| ■ 35 mm 1 3/8" | A = 92mm A = 3 5/8" | CSK35-RED |



| | | |
|-----------------------|-------------------------|-----------|
| ● 16 mm 5/8" | Ø = 63mm Ø = 2 1/2" | CSR16CARB |
| ● 40 mm 1 5/8" | Ø = 120mm Ø = 4 3/4" | CSR40CARB |
| ● 42.4 mm 1 11/16" | Ø = 80mm Ø = 3 1/8" | CSR42CARB |

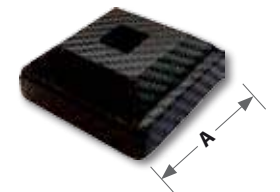

| | | |
|-------------------|------------------------|-----------|
| ■ 16 mm 5/8" | A = 60mm A = 2 3/8" | CSK16CARB |
| ■ 35 mm 1 3/8" | A = 92mm A = 3 5/8" | CSK35CARB |

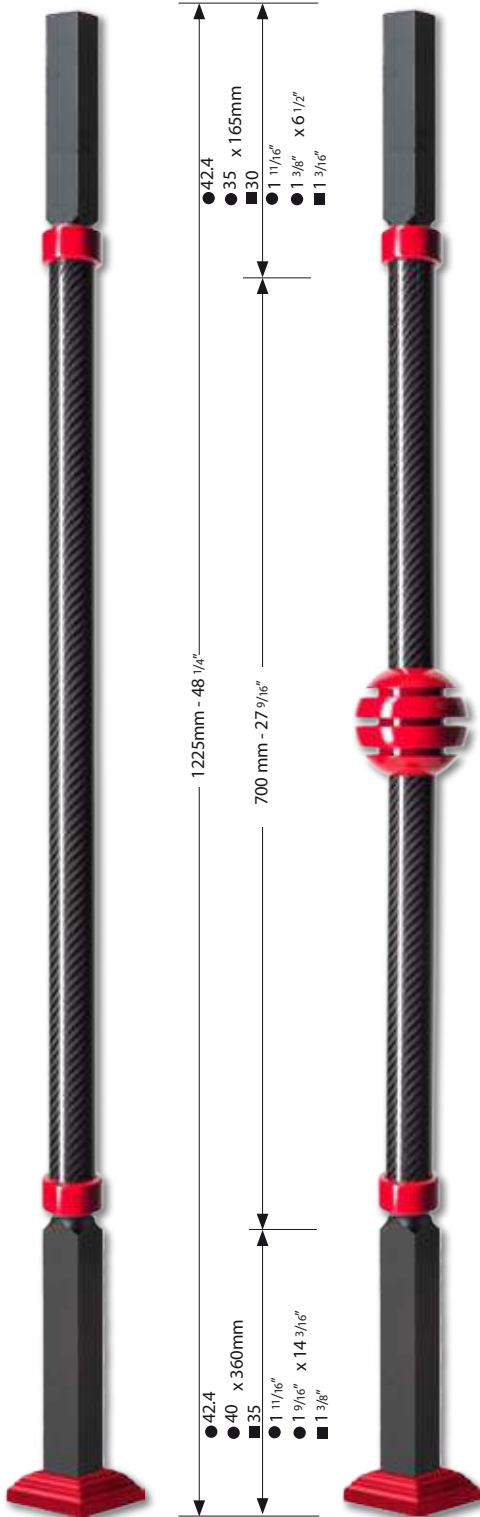

1225mm - 48 1/4"
700 mm - 27 9/16"

42.4
● 40 x 360mm
● 35
■ 1 11/16" x 14 3/16"
■ 1 3/8"

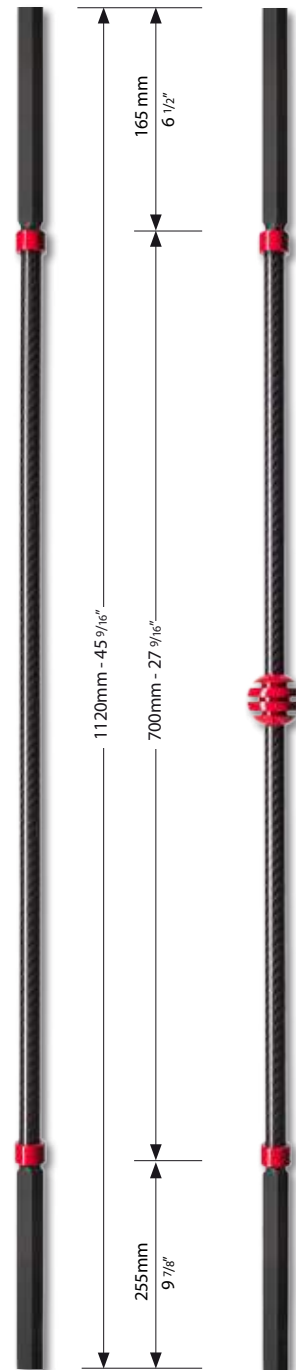

165 mm
6 1/2"
1120mm - 45 9/16"
700mm - 27 9/16"

255mm
9 7/8"

| | | |
|----------------------------|--------------|--------------|
| ● 40 mm 1 5/8" | PCAR10-R-RED | PCAR11-R-RED |
| ● 42.4 mm INOX 1 11/16" | PCAR10-W-RED | PCAR11-W-RED |
| ■ 35 mm 1 3/8" | PCAR10-K-RED | PCAR11-K-RED |

| | | | |
|--------------|--------------|--------------------|---|
| BCAR10-R-RED | BCAR11-R-RED | 16 mm 5/8" | ● |
| BCAR10-W-RED | BCAR11-W-RED | 16 mm INOX 5/8" | ● |
| BCAR10-K-RED | BCAR11-K-RED | 16 mm 5/8" | ■ |



CARBONE BLUE

ø 90mm
H: 140mm

ø 3 1/2"
H: 5 1/2"

ø 100mm
H: 140mm

ø 4"
H: 5 1/2"



TCARB-BLU



TBL90-BLU



TBL70-BLU

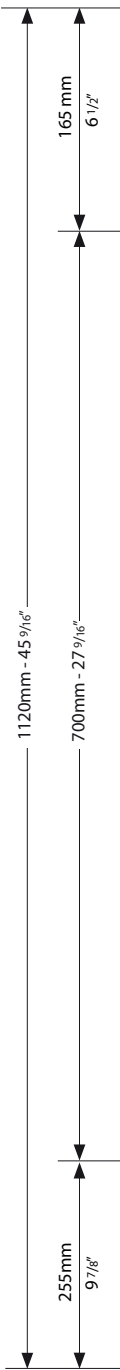
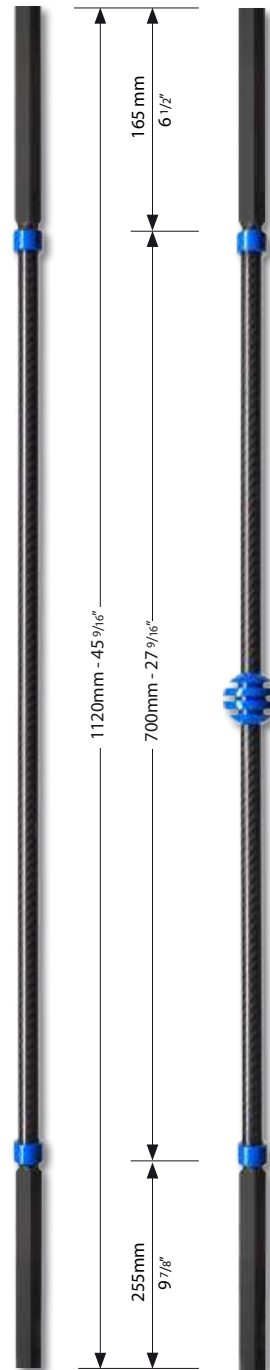
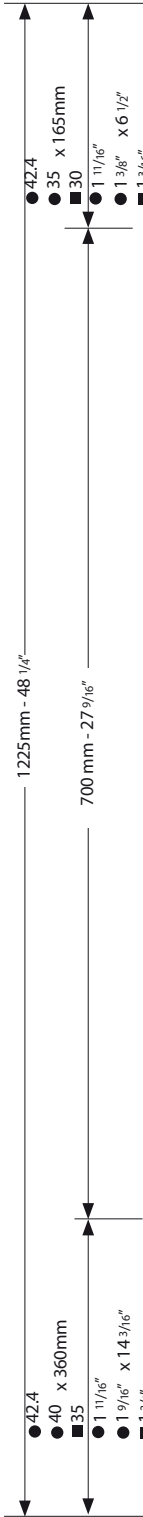
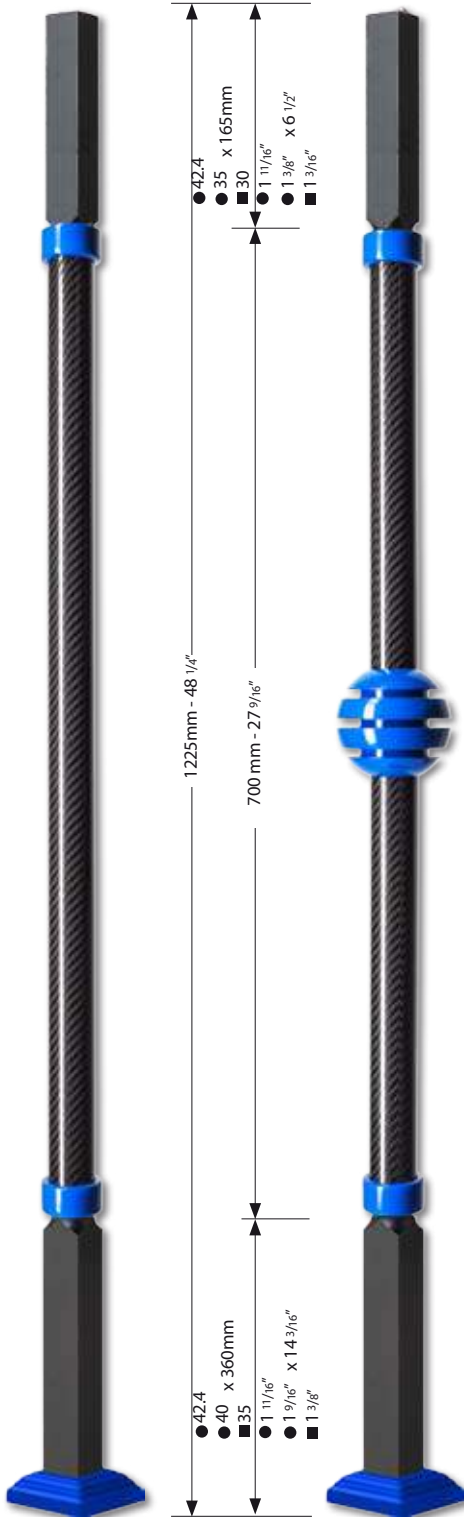

| | | |
|-----------------------|-------------------------|-----------|
| ● 16 mm 5/8" | Ø = 63mm Ø = 2 1/2" | CSR16-BLU |
| ● 40 mm 1 5/8" | Ø = 120mm Ø = 4 3/4" | CSR40-BLU |
| ● 42.4 mm 1 11/16" | Ø = 80mm Ø = 3 1/8" | CSR42-BLU |

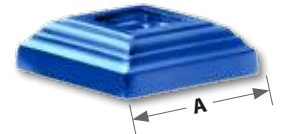

| | | |
|-------------------|------------------------|-----------|
| ■ 16 mm 5/8" | A = 60mm A = 2 3/8" | CSK16-BLU |
| ■ 35 mm 1 3/8" | A = 92mm A = 3 5/8" | CSK35-BLU |



| | | |
|-----------------------|-------------------------|-----------|
| ● 16 mm 5/8" | Ø = 63mm Ø = 2 1/2" | CSR16CARB |
| ● 40 mm 1 5/8" | Ø = 120mm Ø = 4 3/4" | CSR40CARB |
| ● 42.4 mm 1 11/16" | Ø = 80mm Ø = 3 1/8" | CSR42CARB |

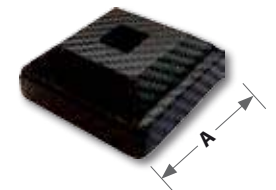

| | | |
|-------------------|------------------------|-----------|
| ■ 16 mm 5/8" | A = 60mm A = 2 3/8" | CSK16CARB |
| ■ 35 mm 1 3/8" | A = 92mm A = 3 5/8" | CSK35CARB |

| | | |
|----------------------------|--------------|--------------|
| ● 40 mm 1 5/8" | PCAR10-R-BLU | PCAR11-R-BLU |
| ● 42.4 mm INOX 1 11/16" | PCAR10-W-BLU | PCAR11-W-BLU |
| ■ 35 mm 1 3/8" | PCAR10-K-BLU | PCAR11-K-BLU |

| | | | |
|--------------|--------------|--------------------|---|
| BCAR10-R-BLU | BCAR11-R-BLU | 16 mm 5/8" | ● |
| BCAR10-W-BLU | BCAR11-W-BLU | 16 mm INOX 5/8" | ● |
| BCAR10-K-BLU | BCAR11-K-BLU | 16 mm 5/8" | ■ |



CARBONE WHITE

ø 90mm
H: 140mm

ø 3 1/2"
H: 5 1/2"



TCARB-WHI



TBL90-WHI

ø 100mm
H: 140mm



TBL70-WHI

ø 54mm
ø 2 1/8"

FRANCE
gf
1948

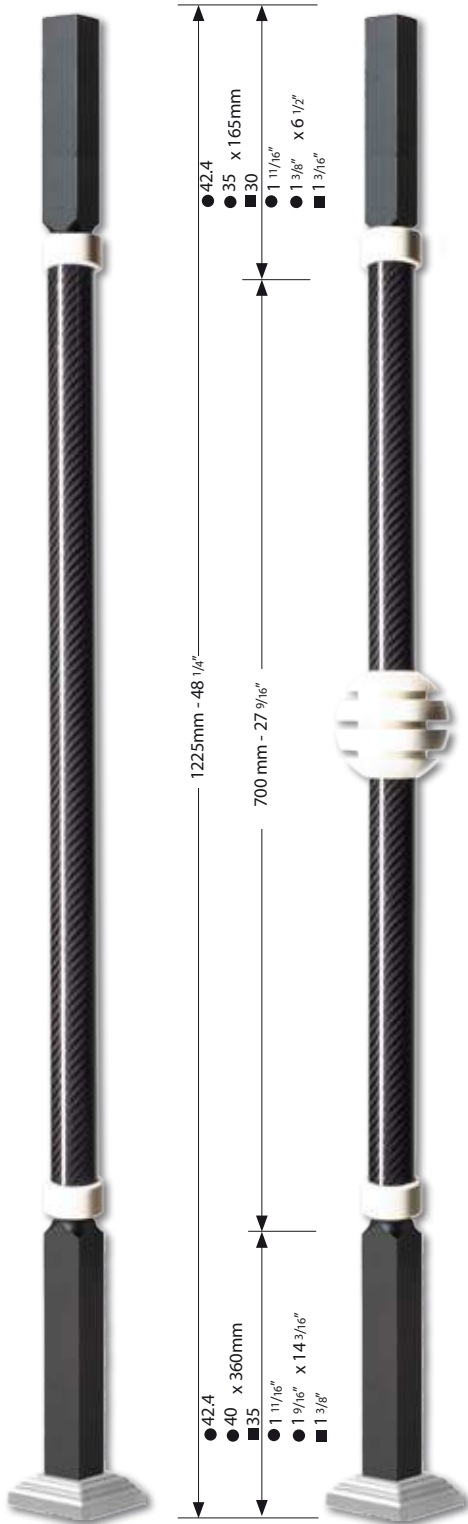

1225mm - 48 1/4"
700mm - 27 9/16"

● 42.4
● 35 x 165mm
■ 30
● 1 11/16"
● 1 3/8" x 6 1/2"
■ 1 3/16"

● 42.4
● 40 x 360mm
■ 35
● 1 11/16"
● 1 9/16" x 14 3/16"
■ 1 3/8"

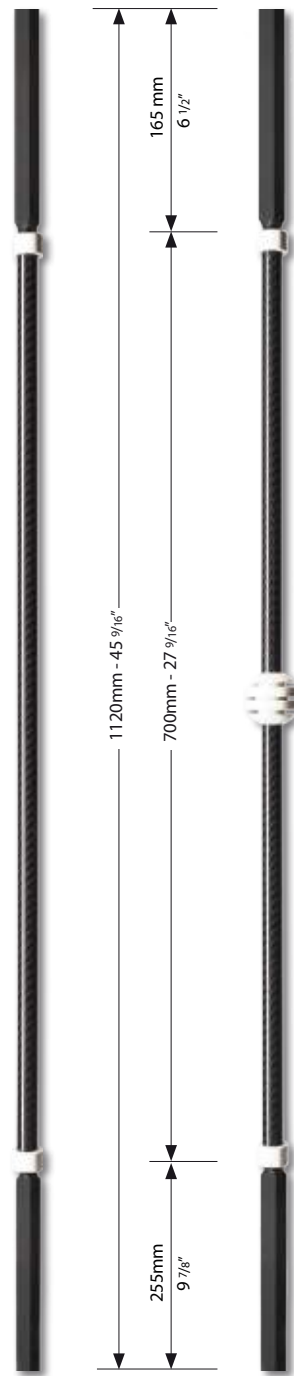

165mm
6 1/2"

1120mm - 45 9/16"
700mm - 27 9/16"

255mm
9 7/8"



| | | |
|-----------------------|-------------------------|-----------|
| ● 16 mm 5/8" | Ø = 63mm Ø = 2 1/2" | CSR16-WHI |
| ● 40 mm 1 5/8" | Ø = 120mm Ø = 4 3/4" | CSR40-WHI |
| ● 42.4 mm 1 11/16" | Ø = 80mm Ø = 3 1/8" | CSR42-WHI |

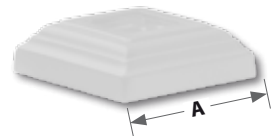

| | | |
|-------------------|------------------------|-----------|
| ■ 16 mm 5/8" | A = 60mm A = 2 3/8" | CSK16-WHI |
| ■ 35 mm 1 3/8" | A = 92mm A = 3 5/8" | CSK35-WHI |



| | | |
|-----------------------|-------------------------|-----------|
| ● 16 mm 5/8" | Ø = 63mm Ø = 2 1/2" | CSR16CARB |
| ● 40 mm 1 5/8" | Ø = 120mm Ø = 4 3/4" | CSR40CARB |
| ● 42.4 mm 1 11/16" | Ø = 80mm Ø = 3 1/8" | CSR42CARB |

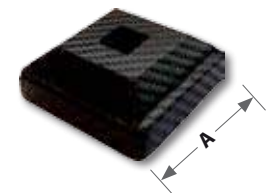

| | | |
|-------------------|------------------------|-----------|
| ■ 16 mm 5/8" | A = 60mm A = 2 3/8" | CSK16CARB |
| ■ 35 mm 1 3/8" | A = 92mm A = 3 5/8" | CSK35CARB |

CARBONE

| | | |
|----------------------------|--------------|--------------|
| ● 40 mm 1 5/8" | PCAR10-R-WHI | PCAR11-R-WHI |
| ● 42.4 mm INOX 1 11/16" | PCAR10-W-WHI | PCAR11-W-WHI |
| ■ 35 mm 1 3/8" | PCAR10-K-WHI | PCAR11-K-WHI |

| | | |
|--------------|--------------|--------------|
| BCAR10-R-WHI | BCAR11-R-WHI | 16 mm ● |
| BCAR10-W-WHI | BCAR11-W-WHI | 16 mm INOX ● |
| BCAR10-K-WHI | BCAR11-K-WHI | 16 mm ■ |



CARBONE

Black Chrome

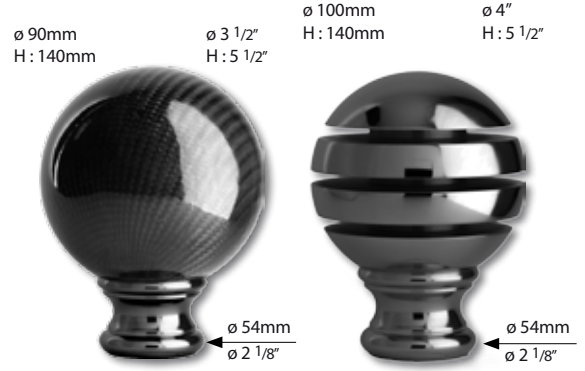

TCARB-CN

TBL70CN

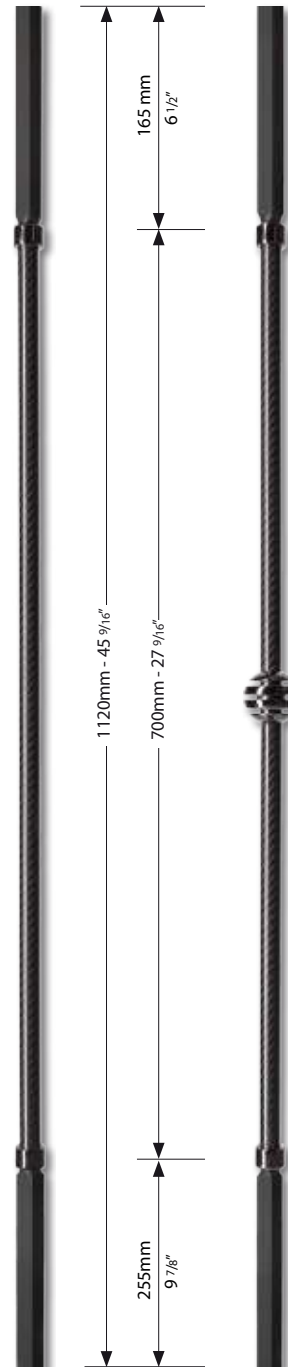
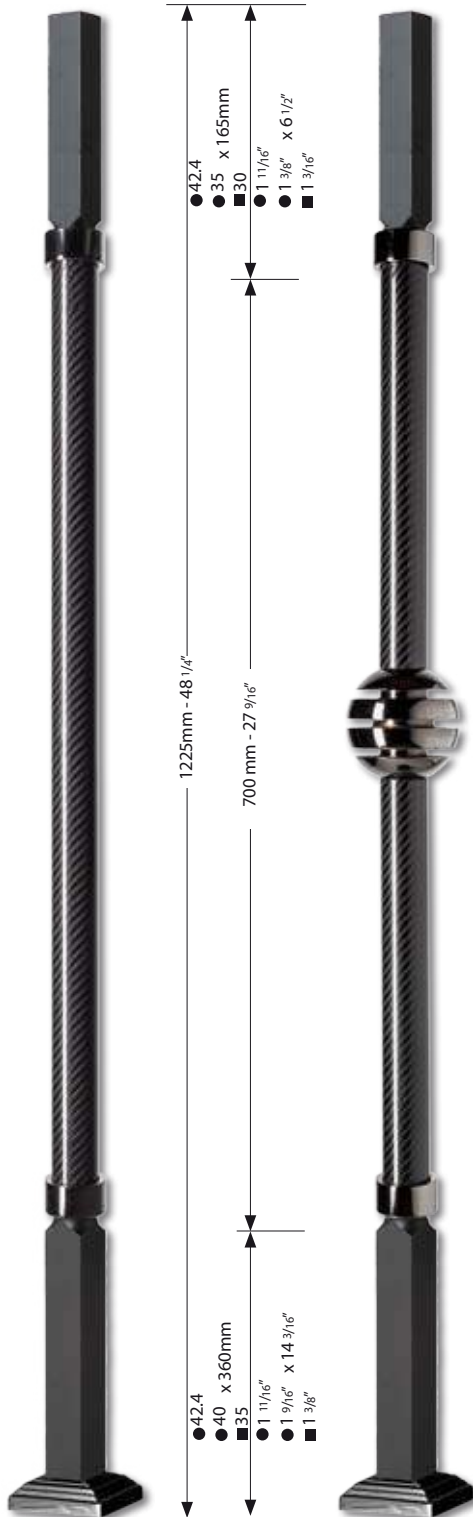

| | | |
|-----------------------|-------------------------|----------|
| ● 16 mm 5/8" | Ø = 63mm Ø = 2 1/2" | CSL61CN |
| ● 40 mm 1 5/8" | Ø = 120mm Ø = 4 3/4" | CSL114CN |
| ● 42.4 mm 1 11/16" | Ø = 80mm Ø = 3 1/8" | CSR42CN |

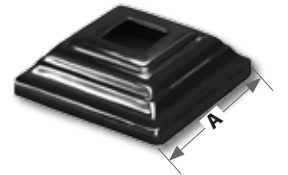

| | | |
|-------------------|------------------------|----------|
| ■ 16 mm 5/8" | A = 60mm A = 2 3/8" | CSL616CN |
| ■ 35 mm 1 3/8" | A = 85mm A = 3 3/8" | CSL835CN |



| | | |
|-----------------------|-------------------------|-----------|
| ● 16 mm 5/8" | Ø = 63mm Ø = 2 1/2" | CSR16CARB |
| ● 40 mm 1 5/8" | Ø = 120mm Ø = 4 3/4" | CSR40CARB |
| ● 42.4 mm 1 11/16" | Ø = 80mm Ø = 3 1/8" | CSR42CARB |

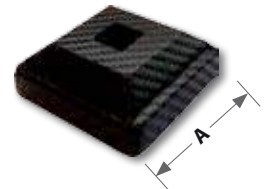

| | | |
|-------------------|------------------------|-----------|
| ■ 16 mm 5/8" | A = 60mm A = 2 3/8" | CSK16CARB |
| ■ 35 mm 1 3/8" | A = 92mm A = 3 5/8" | CSK35CARB |

| | | |
|----------------------------|-------------|-------------|
| ● 40 mm 1 5/8" | PCAR10-R-CN | PCAR11-R-CN |
| ● 42.4 mm INOX 1 11/16" | PCAR10-W-CN | PCAR11-W-CN |
| ■ 35 mm 1 3/8" | PCAR10-K-CN | PCAR11-K-CN |

| | | | |
|----------------------|-------------|-------------|---|
| ● 16 mm 5/8" | BCAR10-R-CN | BCAR11-R-CN | ● |
| ● 16 mm INOX 5/8" | BCAR10-W-CN | BCAR11-W-CN | ● |
| ■ 16 mm 5/8" | BCAR10-K-CN | BCAR11-K-CN | ■ |



FRANÇAIS : Départs de rampe "LATERAL", en acier moulé recouvert d'un film carbone.
Livrés avec une sous-lisse en fer plat de 20/12 mm.

ENGLISH : "LATERAL" rail ends, made of cast steel with carbon cover.
Supplied with a 20/12 mm (3/4" x 1/2") steel scroll.

FRANÇAIS : Support - cavalier de main courante en fer brut à souder à la sous-lisse. Produits conçus exclusivement pour l'intérieur.

ENGLISH : Handrail brackets made of steel, to weld on. Items for indoor use only.

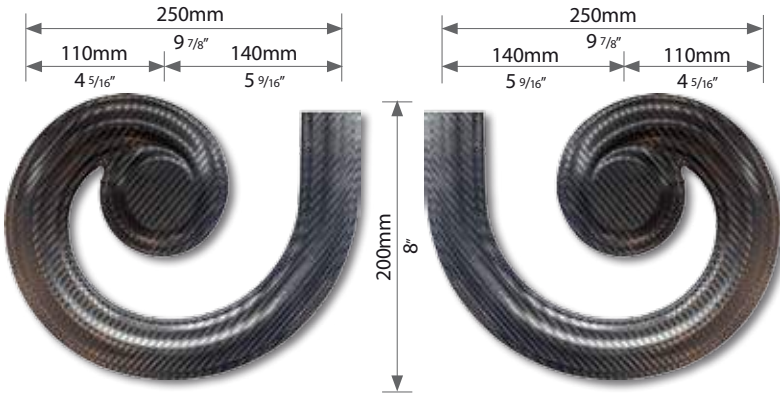

DR 245 LCARB

DR 245 RCARB

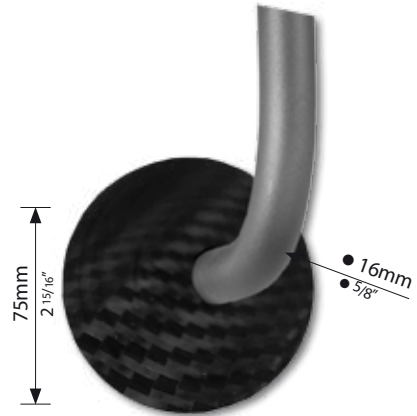

SML 31 CARB

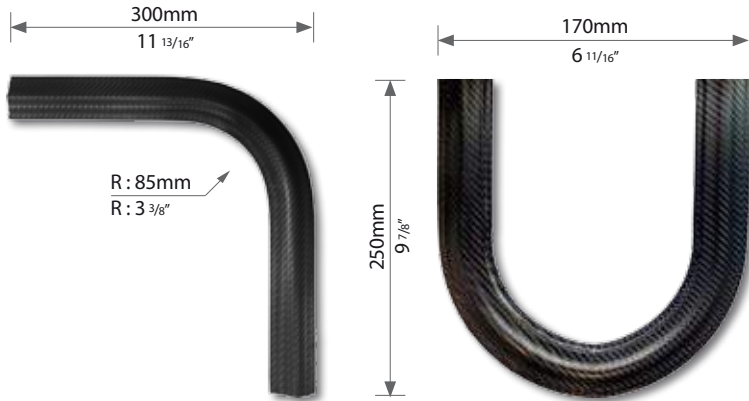

CO-CARB

CU-CARB

FRANÇAIS : Film adhésif à effet texturé 3D Carbone pour recouvrir les mains courantes. Largeur 120 mm

ENGLISH : Carbon 3D textured adhesive film for covering handrails. Width 120 mm



FILM-CARBONE

Vendu au mètre. A spécifier lors de la commande.
Sold by the meter. To be specified when ordering.
Продается по метру. Указать при заказе

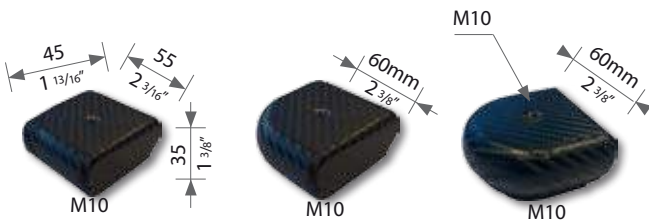

TS6CARB

TS5CARB

TS4CARB

Embase passante
Passing base

Embase d'angle
Base for angle

Embase d'extrémité
Extremity base

FRANÇAIS : Bague couvre-joint en acier moulé recouvert d'un film carbone.

ENGLISH : Steel castings coverjoint collar with carbon cover.



RA 40 CARB

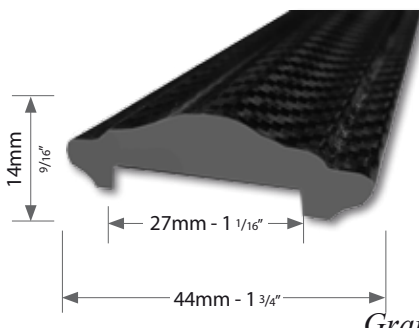

FRANÇAIS : Main courante en fer mouluré recouvert d'un film carbone. Livrée en longueur de 3 mètres.

ENGLISH : Formed steel handrail with carbon cover. Supplied in 3 meter (ca. 10 ft.) lengths.

MC-CARB

FRANÇAIS : Départ en acier recouvert d'un film carbone, prévu pour sous-lisse en plat de 20 x 12 mm.

ENGLISH : Rail ends, made of cast steel with carbon cover. Supplied with a 20/12 mm (3/4" x 1/2") steel scroll.



DRC 305 CARB

G=Gold NI=Nickel SA=Satin

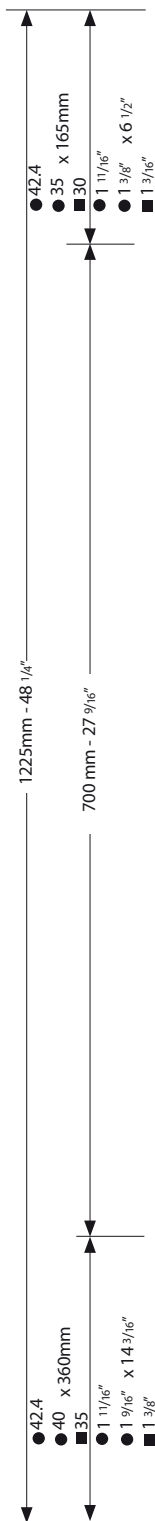

| | | | | | | |
|----------------------------|------------|------------|-------------|-------------|-------------|-------------|
| ● 40 mm 1 5/8" | PCAR10-R-G | PCAR11-R-G | PCAR10-R-NI | PCAR11-R-NI | PCAR10-R-SA | PCAR11-R-SA |
| ● 42.4 mm INOX 1 11/16" | PCAR10-W-G | PCAR11-W-G | PCAR10-W-NI | PCAR11-W-NI | PCAR10-W-SA | PCAR11-W-SA |
| ■ 35 mm 1 3/8" | PCAR10-K-G | PCAR11-K-G | PCAR10-K-NI | PCAR11-K-NI | PCAR10-K-SA | PCAR11-K-SA |



ø 90mm
H: 140mm

ø 3 1/2"
H: 5 1/2"

ø 100mm
H: 140mm

ø 4"
H: 5 1/2"



ø 54mm
ø 2 1/8"

ø 54mm
ø 2 1/8"

TCARB-G

TCARB-NI

TCARB-SA

TBL70G

TBL70NI

TBL70SA



| | | |
|-----------------------|--------------------------|----------------|
| ● 16 mm 5/8" | Ø = 63mm Ø = 2 1/2" | CSL61G |
| ● 40 mm 1 5/8" | Ø = 110mm Ø = 4 5/16" | CSL114G |
| ● 42.4 mm 1 11/16" | Ø = 80mm Ø = 3 1/8" | CSR42-G |



| | | |
|-----------------------|--------------------------|-----------------|
| ● 16 mm 5/8" | Ø = 63mm Ø = 2 1/2" | CSL61NI |
| ● 40 mm 1 5/8" | Ø = 110mm Ø = 4 5/16" | CSL114NI |
| ● 42.4 mm 1 11/16" | Ø = 80mm Ø = 3 1/8" | CSR42-NI |

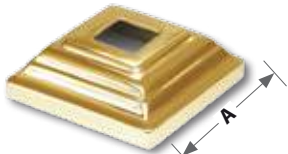

| | | |
|-------------------|------------------------|----------------|
| ■ 16 mm 5/8" | A = 60mm A = 2 3/8" | CSL616G |
| ■ 35 mm 1 3/8" | A = 85mm A = 3 3/8" | CSL835G |

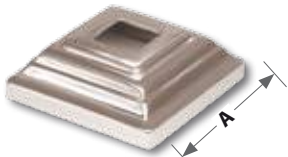

| | | |
|-------------------|------------------------|-----------------|
| ■ 16 mm 5/8" | A = 60mm A = 2 3/8" | CSL616NI |
| ■ 35 mm 1 3/8" | A = 85mm A = 3 3/8" | CSL835NI |

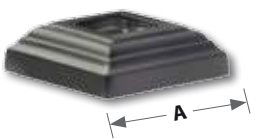

| | | |
|-------------------|------------------------|-----------------|
| ■ 16 mm 5/8" | A = 60mm A = 2 3/8" | CSL616SA |
| ■ 35 mm 1 3/8" | A = 85mm A = 3 3/8" | CSL835SA |



CARBONE

| | | | | | | |
|----------------------|-------------------|-------------------|--------------------|--------------------|--------------------|--------------------|
| ● 16 mm 5/8" | BCAR10-R-G | BCAR11-R-G | BCAR10-R-NI | BCAR11-R-NI | BCAR10-R-SA | BCAR11-R-SA |
| ● 16 mm INOX 5/8" | BCAR10-W-G | BCAR11-W-G | BCAR10-W-NI | BCAR11-W-NI | BCAR10-W-SA | BCAR11-W-SA |
| ■ 16 mm 5/8" | BCAR10-K-G | BCAR11-K-G | BCAR10-K-NI | BCAR11-K-NI | BCAR10-K-SA | BCAR11-K-SA |

CARBONE

Custom Color

FRANÇAIS : Les éléments de couleur jaune peuvent être peints selon la couleur de votre choix. Couleur RAL à spécifier lors de la commande.

ENGLISH: The yellow elements can be painted according to the color of your choice. RAL color to specify when ordering.

RUSSE : Желтые элементы могут быть окрашены в соответствии с цветом по вашему выбору. Цвет RAL указывать при оформлении заказа.

ø 100mm
H: 140mm

ø 4"
H: 5 1/2"



TCARB-SPE



TBL90-SPE



TBL70-SPE

ø 54mm
ø 2 1/8"

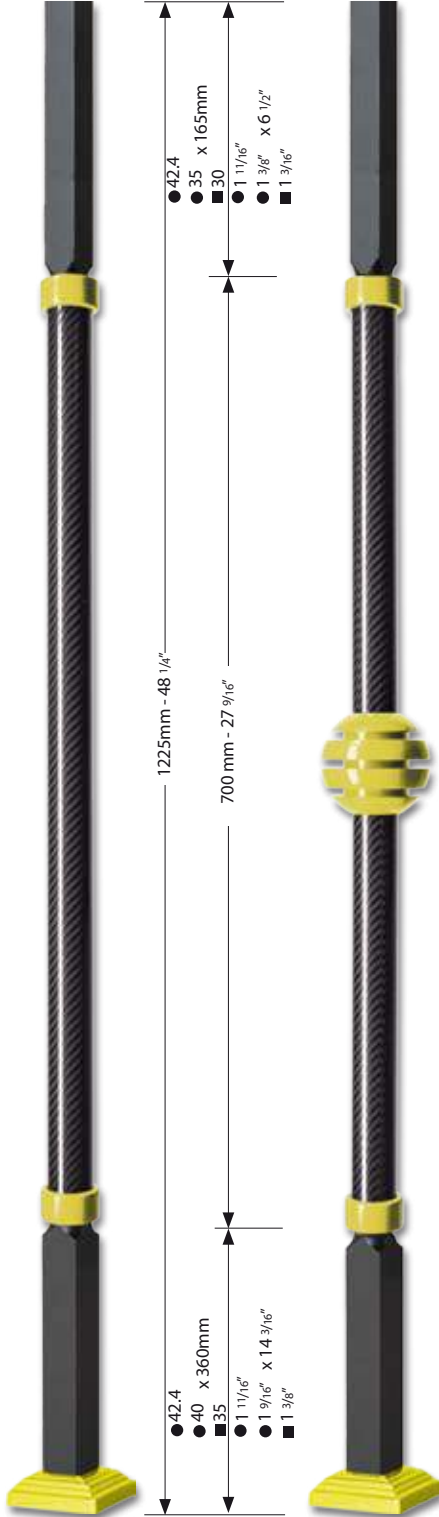

● 42.4
■ 35 x 165mm
■ 30
● 1 1/16"
● 1 3/8" x 6 1/2"
■ 1 3/16"

1225mm - 48 1/4"
700mm - 27 9/16"

● 42.4
■ 40 x 360mm
■ 35
● 1 1/16"
● 1 9/16" x 14 3/16"
■ 1 3/8"

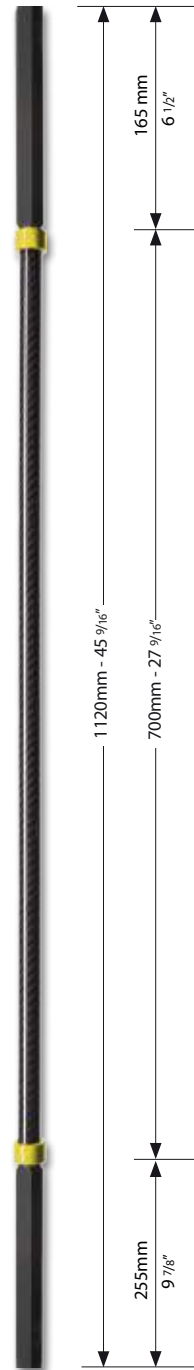

165mm
6 1/2"

1120mm - 45 9/16"
700mm - 27 9/16"

255mm
9 7/8"



| | | |
|-----------------------|-------------------------|------------------|
| ● 16 mm 5/8" | Ø = 63mm Ø = 2 1/2" | CSR16-SPE |
| ● 40 mm 1 5/8" | Ø = 120mm Ø = 4 3/4" | CSR40-SPE |
| ● 42.4 mm 1 11/16" | Ø = 80mm Ø = 3 1/8" | CSR42-SPE |

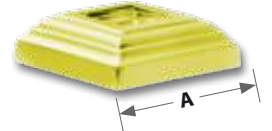

| | | |
|-------------------|------------------------|------------------|
| ■ 16 mm 5/8" | A = 60mm A = 2 3/8" | CSK16-SPE |
| ■ 35 mm 1 3/8" | A = 85mm A = 3 3/8" | CSK35-SPE |



| | | |
|-----------------------|-------------------------|------------------|
| ● 16 mm 5/8" | Ø = 63mm Ø = 2 1/2" | CSR16CARB |
| ● 40 mm 1 5/8" | Ø = 120mm Ø = 4 3/4" | CSR40CARB |
| ● 42.4 mm 1 11/16" | Ø = 80mm Ø = 3 1/8" | CSR42CARB |

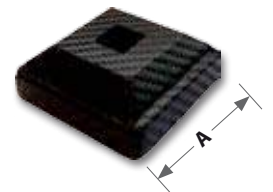

| | | |
|-------------------|------------------------|------------------|
| ■ 16 mm 5/8" | A = 60mm A = 2 3/8" | CSK16CARB |
| ■ 35 mm 1 3/8" | A = 92mm A = 3 5/8" | CSK35CARB |

| | | |
|---------------------------|---------------------|---------------------|
| ● 40 mm 1 5/8" | PCAR10-R-SPE | PCAR11-R-SPE |
| ● 42.4mm INOX 1 11/16" | PCAR10-W-SPE | PCAR11-W-SPE |
| ■ 35 mm 1 3/8" | PCAR10-K-SPE | PCAR11-K-SPE |

| | | |
|---------------------|---------------------|--------------|
| BCAR10-R-SPE | BCAR11-R-SPE | 16 mm ● |
| BCAR10-W-SPE | BCAR11-W-SPE | 16 mm INOX ● |
| BCAR10-K-SPE | BCAR11-K-SPE | 16 mm ■ |



MAINS COURANTES PRÊTES A POSER
READY TO INSTALL HANDRAIL
EINBAUFERTIGER HANDLAUF
LEUNINGEN KLAAR OM OP TE HANGEN
BARANDILLA LISTA PARA INSTALAR
ГОТОВЫЕ К УСТАНОВКЕ ПОРУЧНИ

CARBONE

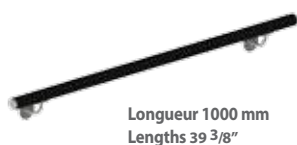
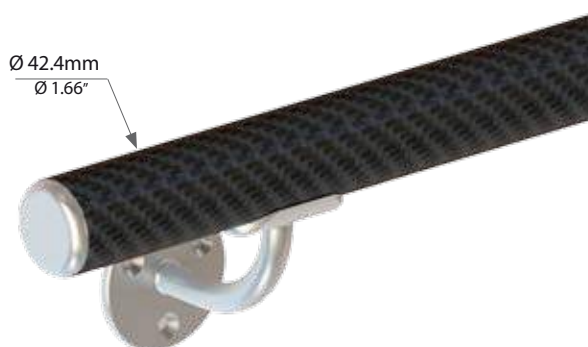
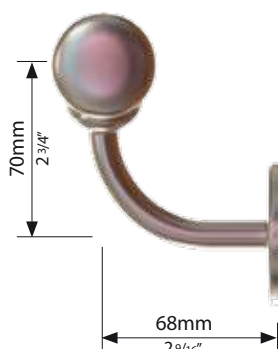
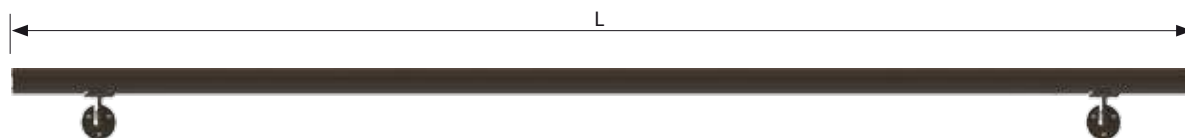

Longueur 1000 mm
Lengths 39 3/8"

MC-C91-1000

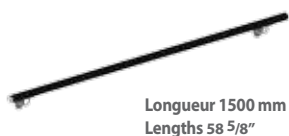

Longueur 1500 mm
Lengths 58 5/8"

MC-C91-1500



Longueur 2000 mm
Lengths 78"

MC-C91-2000

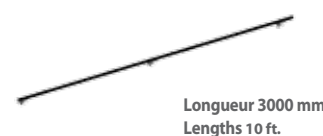

Longueur 3000 mm
Lengths 10 ft.

MC-C91-3000

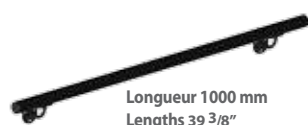
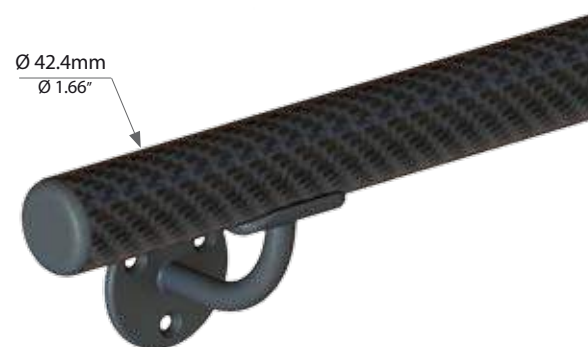
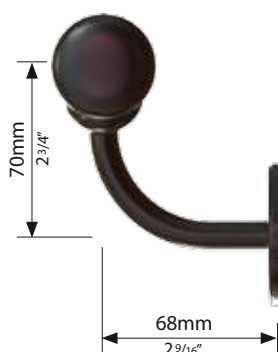

Longueur 1000 mm
Lengths 39 3/8"

MC-CB1-1000

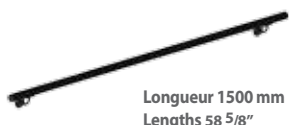

Longueur 1500 mm
Lengths 58 5/8"

MC-CB1-1500



Longueur 2000 mm
Lengths 78"

MC-CB1-2000

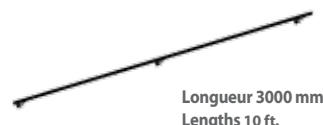

Longueur 3000 mm
Lengths 10 ft.

MC-CB1-3000

CARBONE





CARBONE



POT10-W

9,6 KG

POT11-W

11,45 KG

POT70-W

12,55 KG

POT71-W

14,4 KG



CORDE150-RED L : 1.5 mètres

CORDE200-RED L : 2 mètres

CORDE250-RED L : 2.5 mètres



CORDE150-BLK L : 1.5 mètres

CORDE200-BLK L : 2 mètres

CORDE250-BLK L : 2.5 mètres



FONTE

FRONTE D'ART

FRANÇAIS : Véritable travail d'artiste. Les modèles originaux ont été sculptés par M. René DEIBER, "meilleur ouvrier de France". Poteaux de départ de rampe et balustres dont la partie centrale est en fonte à graphite sphéroïdal (GS). Les extrémités sont en acier, permettant ainsi un montage de la rampe par soudure.

DEUTSCH : Echtes Kunsthandwerk. Die Original-Modelle wurden von Herrn René DEIBER geschnitzt, ausgezeichnet als "bester Handwerker Frankreichs". Hauptstäbe und Zierstäbe mit einem Mittelteil aus Sphäroguß. Die Endstücke sind aus Stahl, so daß beim Zusammenbau des Geländergeschweißst werden kann.

ENGLISH : Genuine work of art. The original models have been carved by Mr. René DEIBER named "best worker of France". Starting posts and balusters of which the body is cast iron (GS). The ends are made of mild steel, allowing for an assembly of the railing by welding.

NEDERLANDS : Echt kunsthandwerk . De originele modellen zijn van de hand van de heer René DEIBER, bekend als de "Beste handwerkvakman van Frankrijk". Hoofdbalusters en sierspijlen uit smeedbaar gietijzer. De eindstukken zijn van staal om het lassen bij samenstelling van de leuning te vergemakkelijken.

ESPAÑOL : Verdadero trabajo de artista . los modelos originales han sido tallados por el Sr. René DEIBER, "mejor artesano de Francia ". Balaustre de arranque con la parte central en fundición de hierro (GS). Los extremos están realizados en hierro, permitiendo el montaje por soldadura.

RUSSE : Творение настоящего художника. Оригинальные модели были созданы «Лучшим мастером Франции», г-ном Рене ДЕБЕРОМ. Центральные части заходных столбов и стоек отлитые из высококачественного и прочного серого чугуна марки GS(graphite sphéroïdal). Стальные окончания позволяют использовать сварку при сборке и монтаже.



FINITIONS STANDARDS

NOUS SOMMES EN MESURE DE PEINDRE LES BARREAUX DANS LA COULEUR DE VOTRE CHOIX.

STANDARD FINISHINGS

WE ARE ABLE TO PAINT THE BALUSTERS AND POSTS IN THE COLOR OF YOUR CHOICE

STANDARD FERTIGUNGEN

WIR SIND IN DER LAGE, DIE STÄBE IN DER FARBE IHRER WAHL ZU STREICHEN

СТАНДАРТНЫЕ ОТДЕЛКИ

МЫ МОЖЕМ ПОКРАСИТЬ БАРЫ В ЦВЕТ ПО ВАШЕМУ ВЫБОРУ



FONTE

ID

Ivoire Doré - Elfenbein Goldfarbig
Ivory Gold Colored - Ivoorkleurig Gold
Marfil Dorado - Позолоченная слоновая кость

BA

Bronze Antique - Antik Bronze
Antic Bronze - Antic Brons
Bronce viejo - Античная бронза

FN

Fer Naturel - Eisen natur
Natural steel - Naturel-Metaalkleur
Hierro natural - Натуральное железо

OR

Or - Goldfarbig
Gold - Of
Oro - Золото

VB

Vieux Bronze - Alt Bronze
Old bronze - Oud brons
Bronce viejo - Состаренная бронза

FONTE D'ART - SPHÄROGUSS - CAST IRON GIETIJZER SIERORNAMENTEN - FUNDICION ИСКУССТВО ЗАМОК

INAPTE À LA GALVANISATION - UNGEEIGNET FÜR FEUERVERZINKUNG - NOT SUITABLE FOR HOT DIP GALVANIZING - NIET VERZINKBAAR
NO ARTAS PARA LA GALVANIZACIÓN - НЕЛЬЗЯ ЦИНКОВАТЬ ГОРЯЧИМ СПОСОБОМ.

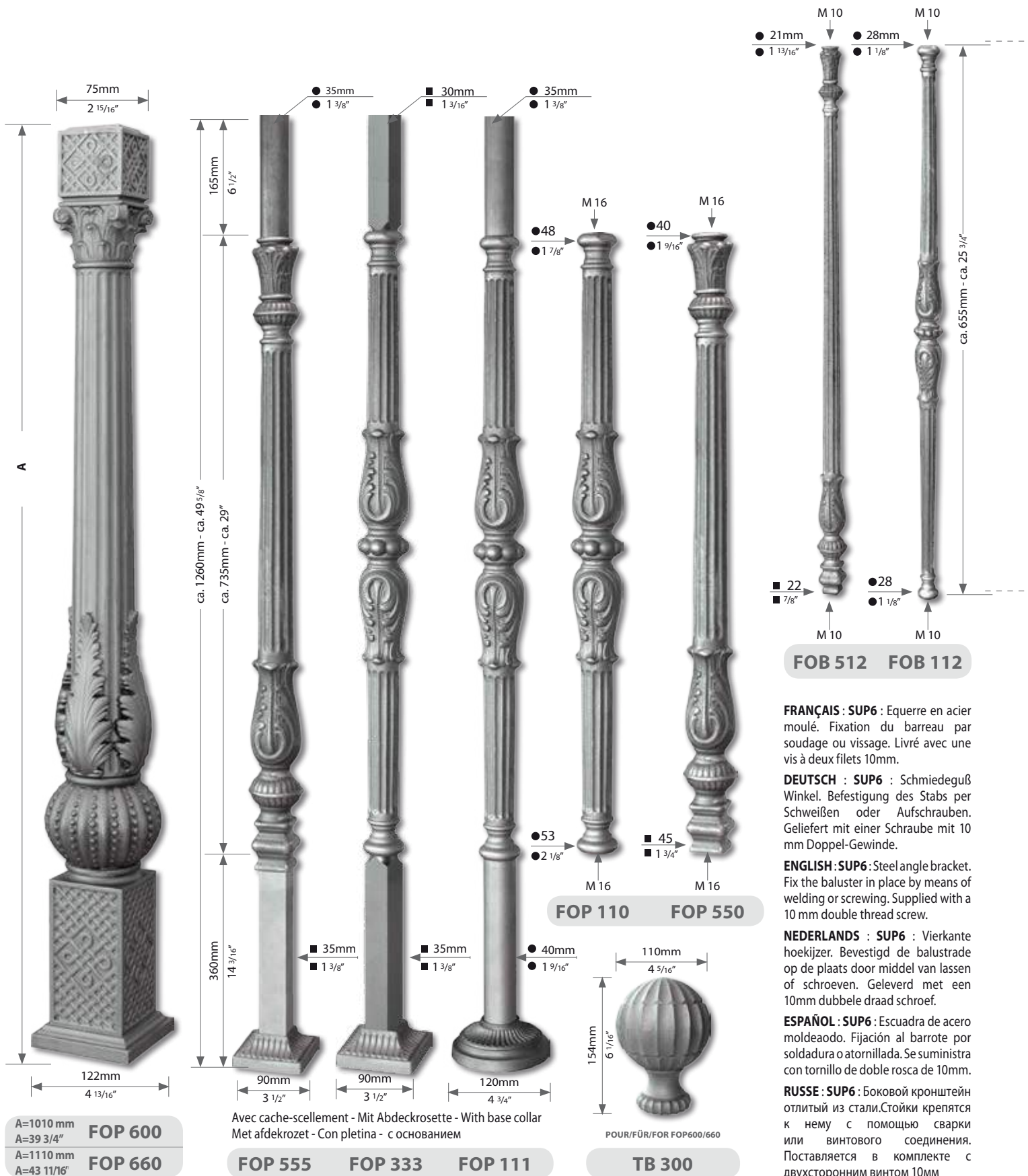

INAPTE À LA GALVANISATION - UNGEEIGNET FÜR FEUERVERZINKUNG - NOT SUITABLE FOR HOT DIP GALVANIZING - NIET VERZINKBAAR
NO APTAS PARA LA GALVANIZACIÓN - НЕЛЬЗЯ ЦИНКОВАТЬ ГОРЯЧИМ СПОСОБОМ.

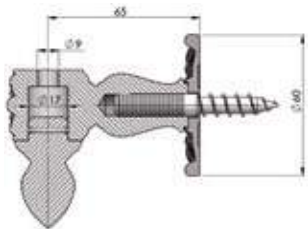
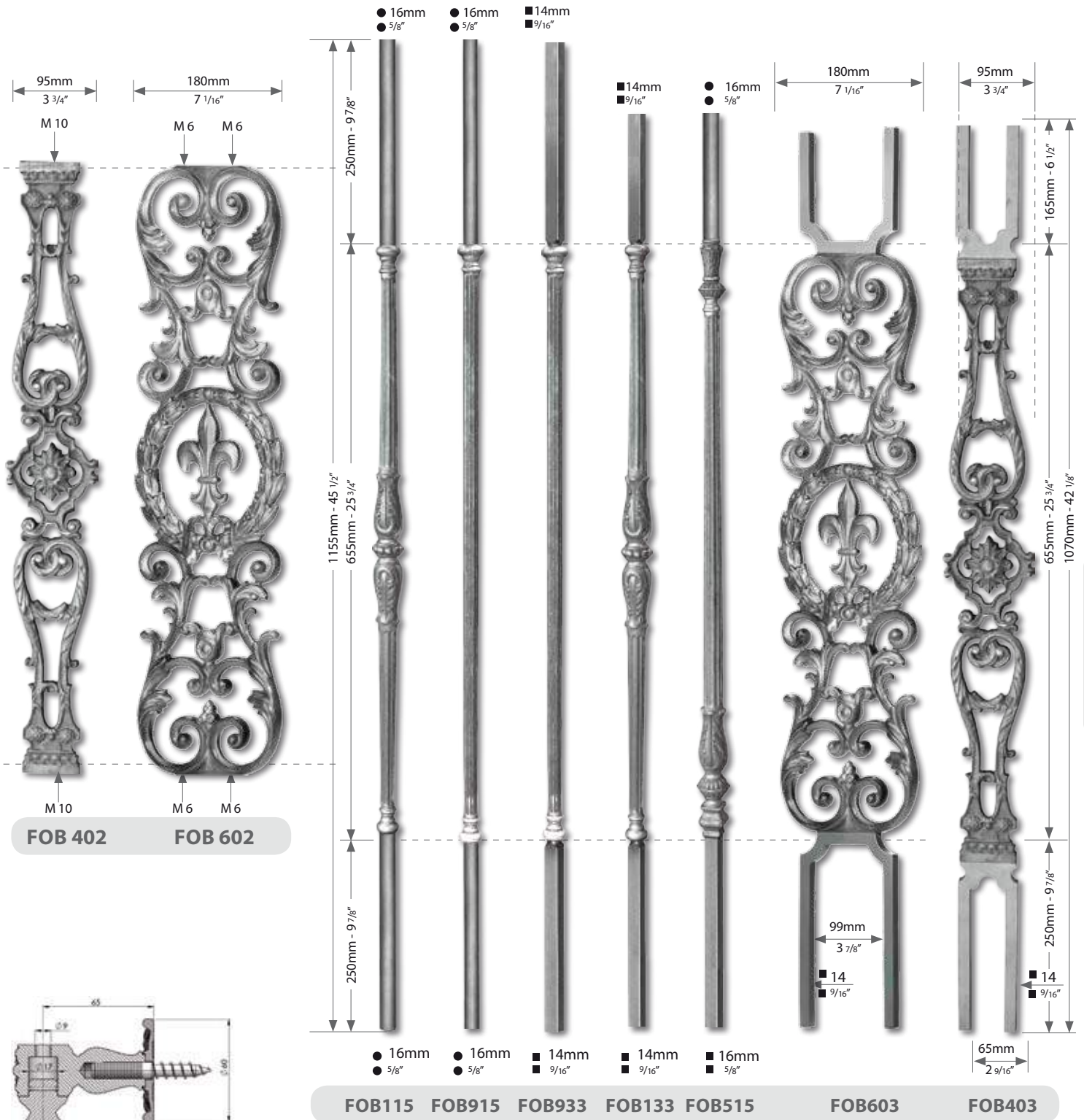

| | | | | | | | |
|--------|-------------|------------------|-------------------|------------------|------------------|-----------------|----------------|
| | | ● 16mm ● 5/8" | ■ 14mm ■ 9/16" | ■ 16mm ■ 5/8" | ■ 16mm ■ 5/8" | 65mm 2 9/16" | 26mm 1 7/8" |
| Brut | Raw | FOC 16 | сырье FOC 52 | Roh | FOC 62 | Bruto | FOC 403 |
| Zingué | zing plated | FOC 16 Z | FOC 52 Z | FOC 62 Z | FOC 403 Z | | |

FORTE



FRONTE D'ART - SPHÄROGUSS CAST IRON - FUNDICION

- * FINITIONS DISPONIBLES: A PRECISER AU MOMENT DE LA COMMANDE.
- * LIEFERBARE FERTIGUNGEN BITTE BEI DER BESTELLUNG ANGEBEN.
- * PLEASE CHOOSE THE FINISH AT TIME OF ORDERING.
- * DE GEWENSTE AFWERKING BIJ UW BESTELLING DOORGEVEN.
- * LOS ACABADOS DISPONIBLES SE INDICAN AL HACER EL PEDIDO.
- * ВОЗМОЖНЫЕ ВАРИАНТЫ ОТДЕЛКИ: ПРОСЬБА УТОЧНЯТЬ В МОМЕНТ ОФОРМЛЕНИЯ ЗАКАЗА.

LA FINITION «BA» EST UTILISÉE SUR TOUTE LA PAGE: FOP 129 BA, FOB 439 BA, ETC.
 AUF DER GANZEN SEITE IST DIE FERTIGUNG «BA» ANGEWANDT: FOP 129 BA, FOB 439 BA, USW.
 THE FINISH «BA» IS USED FOR EVERY ITEM ON THIS PAGE: FOP 129 BA, FOB 439 BA, ETC.
 OP DEZE PAGINA WORDT DE AFWERKING «BA» TOEGEPAST: FOP 129 BA, FOB 439 BA, ETC.
 EL ACABADO «BA» SE UTILIZA EN TODA LA PÁGINA: FOP 129 BA, FOB 439 BA, ETCÉTERA.
 ВСЕ ЭЛЕМЕНТЫ ПРЕДСТАВЛЕННЫЕ НА ЭТОЙ СТРАНИЦЕ ИМЕЮТ ОТДЕЛКУ «BA»: FOP 129 BA, FOB 439 BA И ТАК ДАЛЕЕ

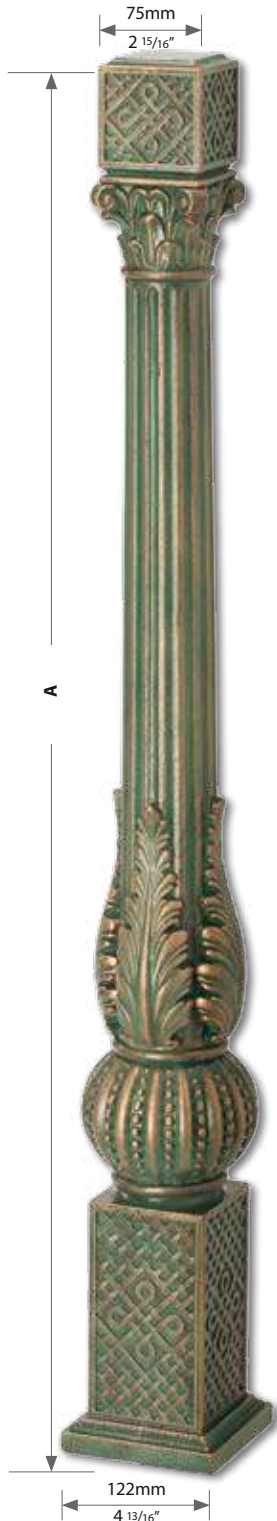

75mm
2 15/16"

A

122mm
4 13/16"



165mm
6 1/2"

ca. 1260mm - ca. 49 5/8"
ca. 735mm - ca. 29"

360mm
14 3/16"

35mm
1 3/8"

90mm
3 1/2"

30mm
1 3/16"

90mm
3 1/2"

35mm
1 3/8"

120mm
4 3/4"

48
1 7/8"

40mm
1 9/16"

40
1 9/16"

110mm
4 5/16"

22
7/8"

154mm
6 1/16"

28mm
1 1/8"

110mm
4 5/16"

M 10

M 10

M 10

M 10

M 16

M 16

M 16

M 16



21mm
1 13/16"

110mm
4 5/16"

28mm
1 1/8"

154mm
6 1/16"

M 10

M 10

M 10

M 10

M 10

M 10

M 10

M 10

M 10

M 10

M 10

M 10

M 10

M 10

FOB 529* FOB 129*

FRANÇAIS : SUP69 : Equerre en acier moulé. Fixation du barreau par soudage ou vissage. Livré avec une vis à deux filets 10mm.

DEUTSCH : SUP69 : Schmiedeguß Winkel. Befestigung des Stabs per Schweißen oder Aufschrauben. Geliefert mit einer Schraube mit 10 mm Doppel-Gewinde.

ENGLISH : SUP69 : Steel angle bracket. Fix the baluster in place by means of welding or screwing. Supplied with a 10 mm double thread screw.

NEDERLANDS : SUP69 : Vierkante hoekijzer. Bevestigd de balustrade op de plaats door middel van lassen of schroeven. Geleverd met een 10mm dubbele draad schroef.

ESPAÑOL : SUP69 : Escuadra de acero moldeado. Fijación al barrote por soldadura o atornillada. Se suministra con tornillo de doble rosca de 10mm.

A=1010 mm
A=39 3/4" **FOP 609***
A=1110 mm
A=43 11/16" **FOP 669***

Avec cache-scellement - Mit Abdeckrosette - With base collar
Met afdekrzet - Con pletina - с основанием
FOP 559* FOP 119* FOP 129*

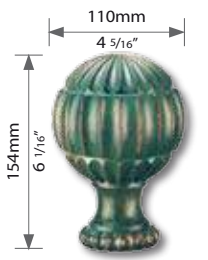

POUR/FÜR/FOR FOP609/669

TB 309*

GIETIJZER SIERORNAMENTEN ИСКУССТВО ЗАМОК

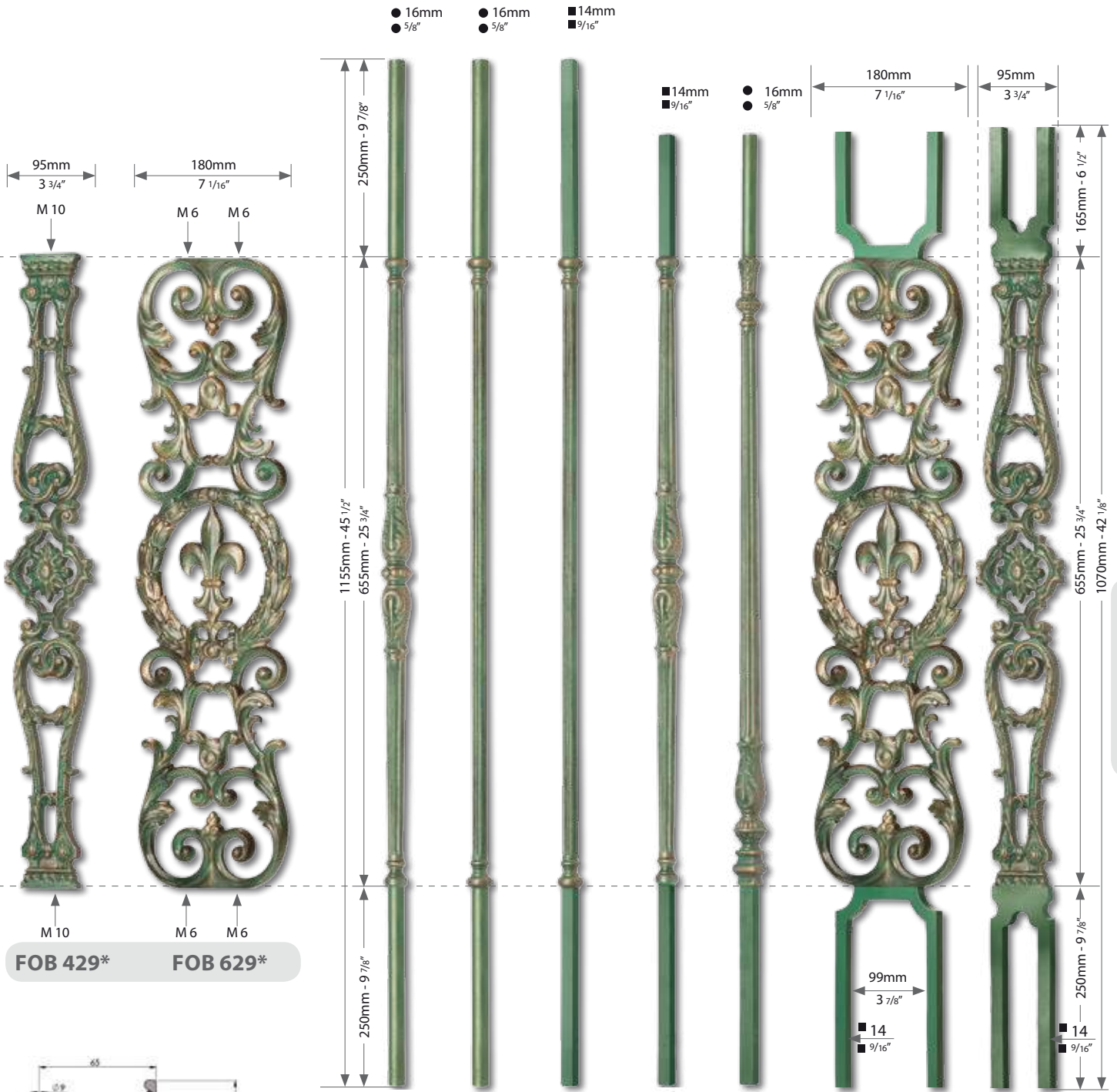

FOB 429*

FOB 629*

FOB119* FOB919* FOB939*

FOB109* FOB519*

FOB639*

FOB439*

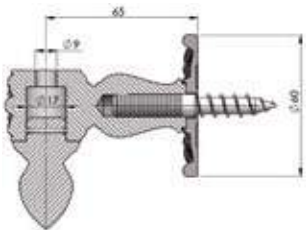

SUP 69*



FOC 19*



FOC 59*



FOC 69*

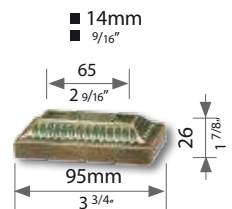

FOC 409*

FRONTE

FRANÇAIS : Pommes de pin en fonte grise, avec taraudage, prêtes à être montées. Livrables brutes de fonderie ou avec revêtement DACROMET® : "ZD". **INAPTE À LA GALVANISATION.**

DEUTSCH : Zieraufsätze aus Grauguß mit Innen-gewinde, montagebereit. Lieferbar roh oder mit DACROMET® beschichtung:"ZD".**UNGEEIGNET FÜR FEUERVERZINKUNG.**

ENGLISH : Pine cones in cast iron, with threaded holes, ready to be mounted. Available as cast or DACROMET® coated : "ZD". **NOT SUITABLE FOR HOT DIP GALVANIZING.**

NEDERLANDS : Gietijzieren paalkoppen met ronde voet en schroefgat voor montage op poortpaal. Leverbaar onbehandeld of met DACROMET® bekleding : "ZD". **NIET VERZINKBAAR.**

ESPAÑOL : Pinas y esferas en fundición gris, con rosca interior, listas para montar. Se suministran en bruto de fundición, ó con DACROMET® revestimiento : "ZD". **NO APTAS PARA LA GALVANIZACIÓN.**

RUSSE : Готовые к установке сосновые шишки из высококачественного серого чугуна с нарезанной внутренней резьбой. Поставляются необработанными или с цинковым покрытием DACROMET® ("ZD"). **Непригодны для цинкования.**

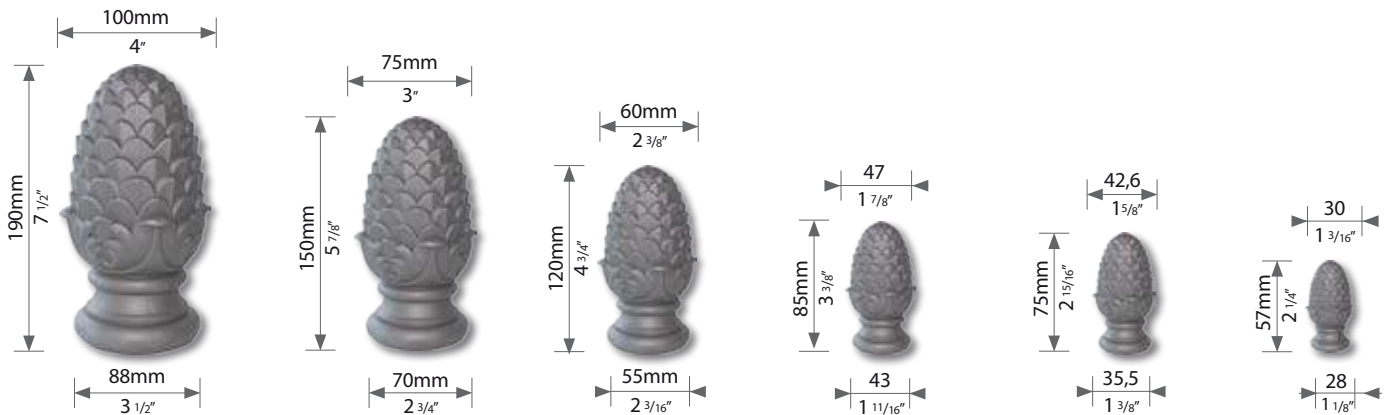

M12 → Page 119 /206

M12 **FOT 15**

M10 → Page 119 /206

M10 → Page 119 /206

M8 **FOT 7**

M8 → Page 119 /206

M12 **FOT 19 ZD**

DACROMET® M12 **FOT 15 ZD**

DACROMET® M10 → Page 119 /206

DACROMET® M10 **FOT 8 ZD**

DACROMET® M8 **FOT 7 ZD**

M8 **FOT 6 ZD**

MANCHONS - ZIERHÜLSEN - SLEEVES - SIERHULZEN - MACOLLAS СОЕДИНИТЕЛЬНЫЕ ЭЛЕМЕНТЫ



| | | |
|-------------------|----------------|--------------------------|
| ● 14 mm 9/16" | FOM 114 | ØA : 32mm ØA : 1 1/4" |
| ● 16 mm 5/8" | FOM 116 | ØA : 32mm ØA : 1 1/4" |
| ● 18 mm 11/16" | FOM 118 | ØA : 35mm ØA : 1 3/8" |

| | | |
|-------------------|----------------|--------------------------|
| ● 14 mm 9/16" | FOM 214 | ØA : 32mm ØA : 1 1/4" |
| ● 16 mm 5/8" | FOM 216 | ØA : 32mm ØA : 1 1/4" |
| ● 18 mm 11/16" | FOM 218 | ØA : 35mm ØA : 1 3/8" |

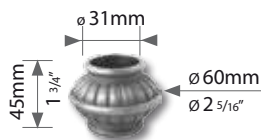

● 30 mm
1 3/16" **EG 831**

● 30 mm
1 3/16" **FOM 721**

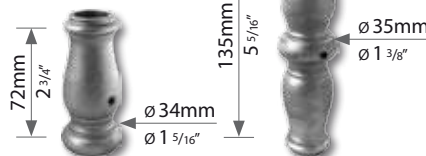
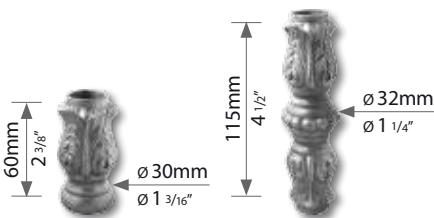

| | | |
|------------------|----------------|----------------|
| ● 14 mm 9/16" | FOM 414 | FOM 814 |
| ● 16 mm 5/8" | FOM 416 | FOM 816 |

| | | |
|------------------|----------------|----------------|
| ● 14 mm 9/16" | FOM 514 | FOM 714 |
| ● 16 mm 5/8" | FOM 516 | FOM 716 |

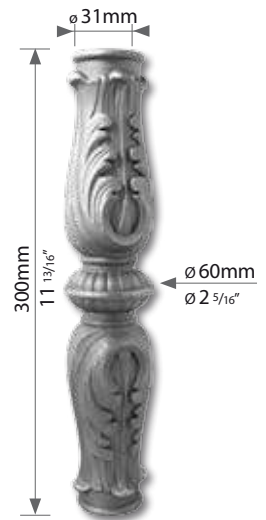
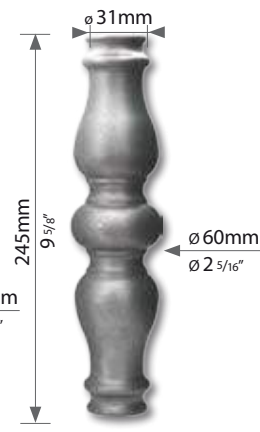
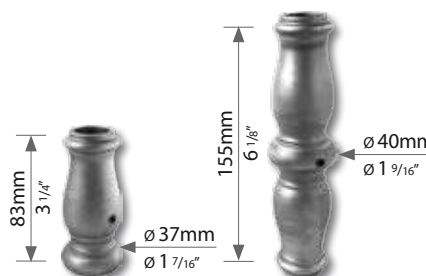
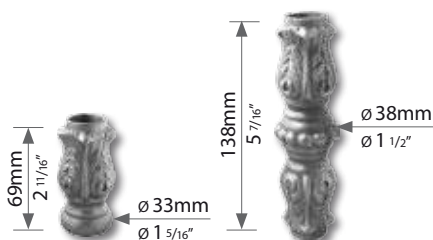

● 18 mm
11/16" **FOM 418**

FOM 818

● 18 mm
11/16" **FOM 518**

FOM 718

● 30 mm
1 3/16" **EG 743**

● 30 mm
1 3/16" **EG 833**

FRANÇAIS : Sphères en fonte grise, avec taraudage, prêtes à être montées. Avec revêtement DACROMET® : "ZD".

DEUTSCH : Zieraufsätze aus Grauguß mit Innen-gewinde, montagebereit. Lieferbar mit DACROMET® beschichtung : "ZD".

ENGLISH : Steel casting balls, with threaded holes, ready to be mounted. DACROMET® coated : "ZD".

NEDERLANDS : Gietijzieren bollen met ronde voet en schroefgat voor montage op poortpaal. Met DACROMET® bekleding : "ZD".

ESPAÑOL : Esferas en fundición gris, con rosca interior, listas para montar. Con DACROMET® revestimiento : "ZD".

RUSSE : Шары отлитые из серого высококачественного чугуна с внутренней резьбой. Обработаны цинковым покрытием DACROMET® : "ZD".

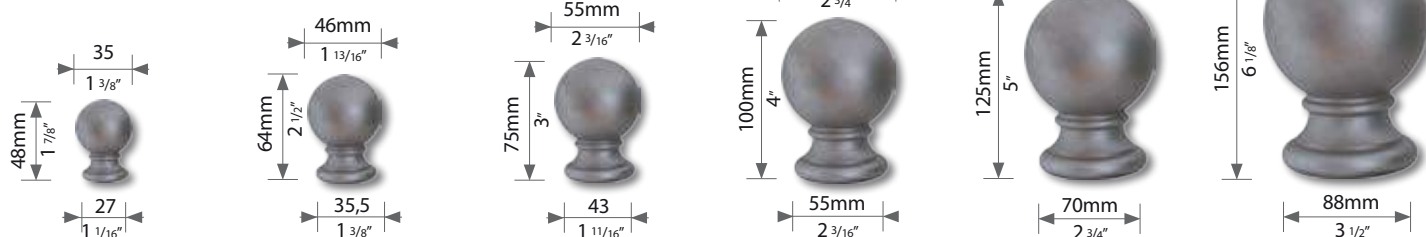

M8 FOS 3 ZD M8 FOS 4 ZD DACROMET® M10 FOS 5 ZD DACROMET® M10 FOS 7 ZD DACROMET® M12 FOS 9 ZD M12 FOS 11 ZD

ORNAMENTS - ORNAMENTEN - ORNAMENTOS - УКРАШЕНИЯ

FRANÇAIS : Eléments décoratifs SIMPLE FACE, en fonte grise - avec vis de fixation. Livrables bruts de fonderie, ou avec revêtement DACROMET® : "ZD".

DEUTSCH : Zierelemente, EINSEITIG, aus Grauguß - mit Befestigungsschrauben. Lieferbar roh oder mit DACROMET® beschichtung : "ZD".

ENGLISH : Cast iron ornaments, SINGLE FACED, delivered with fixing screws. Available as cast or DACROMET® coated : "ZD".

NEDERLANDS : Sierornamenten uit grijs gietijzer. Eenzijdig geprofileerd en voorzien van bevestigingsschroeven. Leverbaar als omschreven, of met DACROMET® bekleding : "ZD".

ESPAÑOL : Elementos decorativos de una SOLA CARA, en fundición gris. Se suministra con tornillos de fijación. Se sirven en bruto de fundición ó con DACROMET® revestimiento : "ZD".

RUSSE : Односторонние декоративные элементы из серого чугуна - с крепежными винтами. Сырые отливки или с покрытием DACROMET® : «ZD».



| | | |
|-----------|------------------|-------------------|
| | FOD 40 | FOD 400 |
| DACROMET® | FOD 40 ZD | FOD 400 ZD |



| | | |
|-----------|------------------|------------------|
| | FOD 60 | FOD 45 |
| DACROMET® | FOD 60 ZD | FOD 45 ZD |

FRONTE

FRONTE GRISA - GRAUGUSS - CAST IRON GIETIJZER SIERORNAMENTEN - FUNDICION

SIMPLE FACE - EINSEITIG - ПРОСТОЕ ЛИЦО

FRANÇAIS : Eléments décoratifs SIMPLE FACE, en fonte grise - avec vis de fixation. Livrables bruts de fonderie, métallisés au zinc : "Z" ou avec revêtement DACROMET® : "ZD".

DEUTSCH : Zierelemente, EINSEITIG, aus Grauguß- mit Befestigungsschrauben. Lieferbar roh, Zinkspritz metallisiert : "Z" oder mit DACROMET® beschichtung : "ZD".

ENGLISH : Cast iron ornaments, SINGLE FACED, delivered with fixing screws. Available as cast, with metallic zinc spray : "Z" or DACROMET® coated : "ZD".

NEDERLANDS : Sierornamenten uit grijs gietijzer. Eenzijdig geprofileerd en voorzien van bevestigingsschroeven. Leverbaar als omschreven, gemetaliseerd : "Z" of met DACROMET® bekleding : "ZD".

ESPAÑOL : Elementos decorativos de una SOLA CARA, en fundición gris. Se suministra con tornillos de fijación. Se sirven en bruto de fundición, metalizados en zinc : "Z" ó con DACROMET® revestimiento : "ZD".

**INAPTE À LA GALVANISATION - UNGEEIGNET FÜR FEUERVERZINKUNG - NOT SUITABLE FOR HOT DIP GALVANIZING - NIET VERZINKBAAR
NO APTAS PARA LA GALVANIZACIÓN - НЕЛЬЗЯ ЦИНКОВАТЬ ГОРЯЧИМ СПОСОБОМ.**

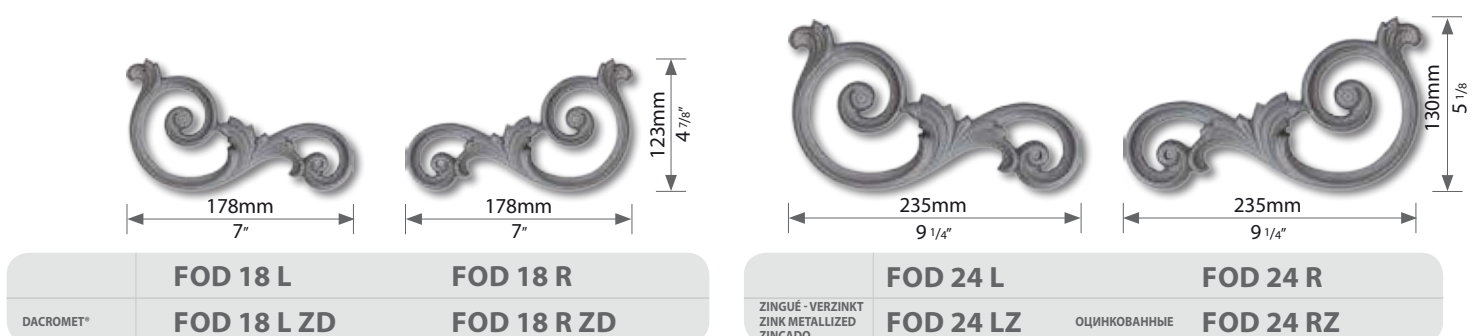
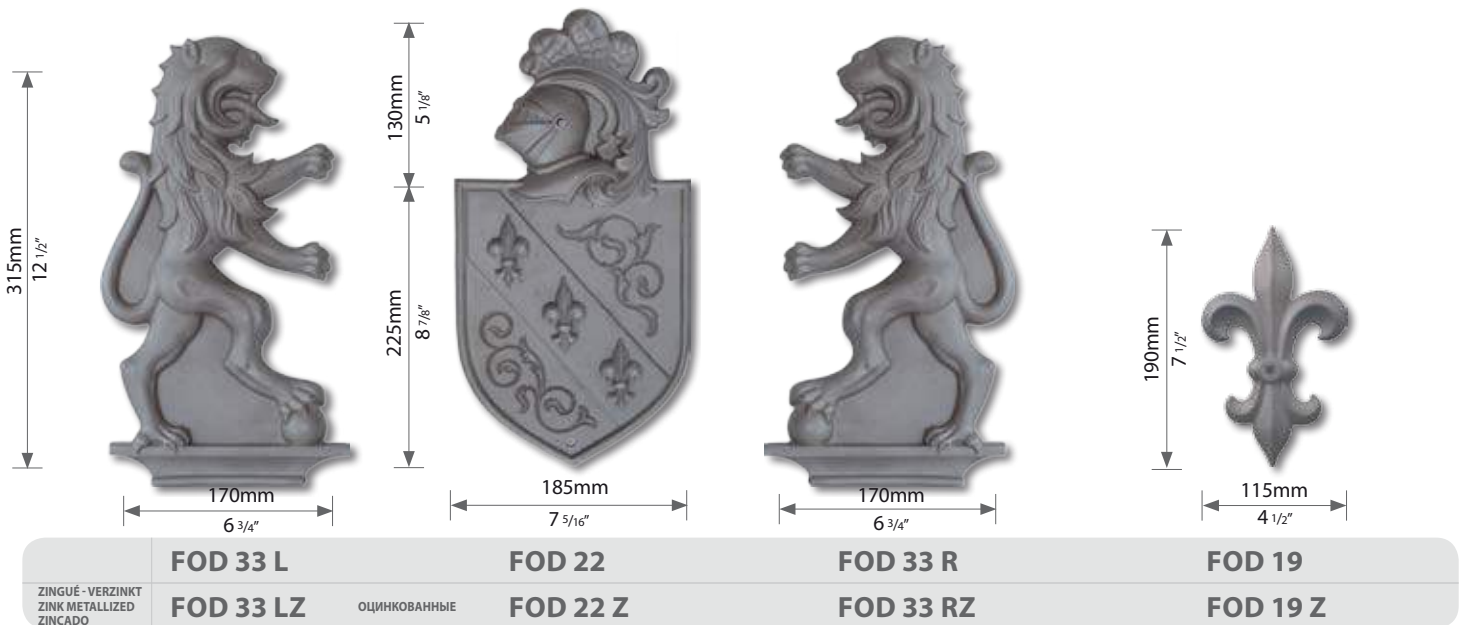
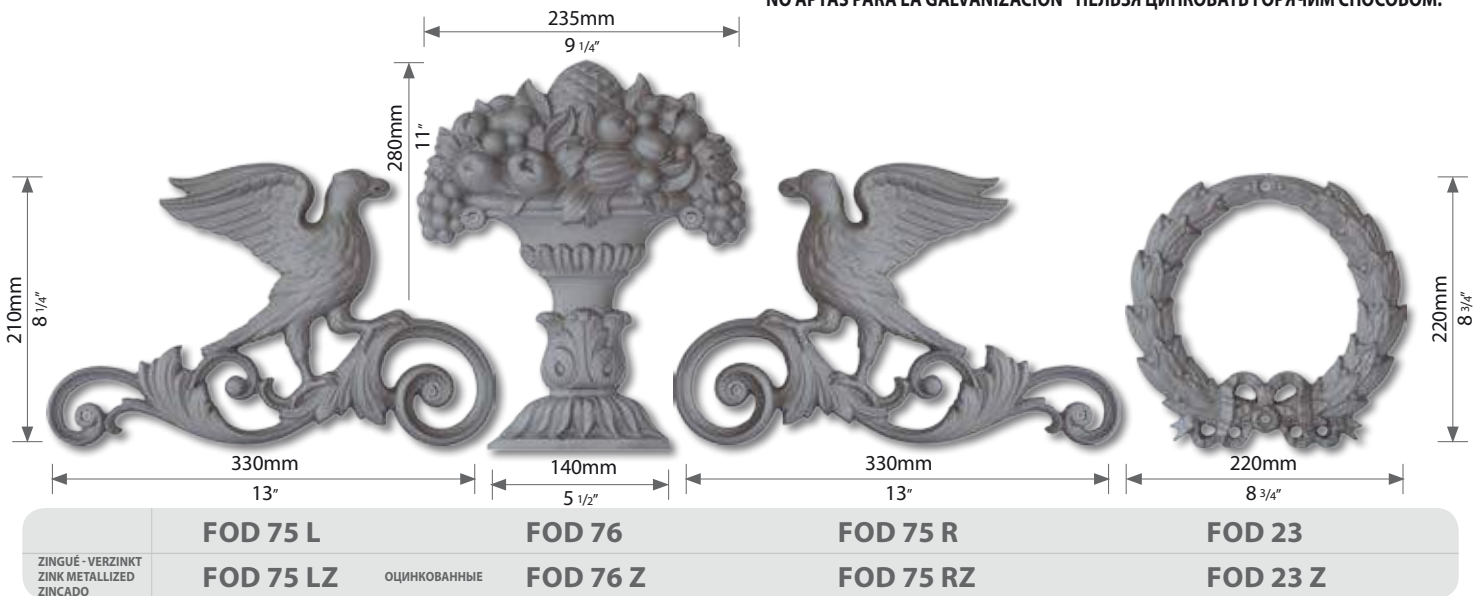

SIMPLE FACE - SIMPLE FACE - ПРОСТОЕ ЛИЦО

RUSSE : DÉCORATIFS UNIDIRECTIONNELS ÉLÉMENTS FONDUS EN HAUTE QUALITÉ EN FER FUS, ENSEMBLE AVEC DES VIS DE FIXATION. FOURNISSENT NON TRAITÉS OU ZINCQUÉS: "Z" OU "ZD" AVEC UN REVÊTEMENT DACROMET®.

**INAPTE À LA GALVANISATION - UNGEEIGNET FÜR FEUERVERZINKUNG - NOT SUITABLE FOR HOT DIP GALVANIZING - NIET VERZINKBAAR
NO APTAS PARA LA GALVANIZACIÓN - НЕЛЬЗЯ ЦИНКОВАТЬ ГОРЯЧИМ СПОСОБОМ.**

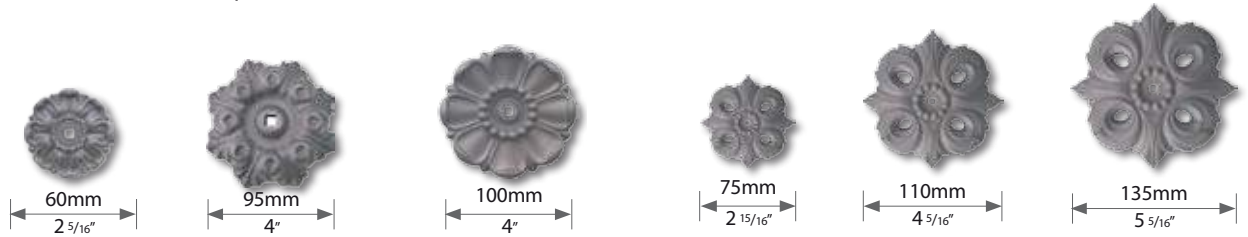

| | | | | | | |
|-----------|--------------|------------------|------------------|------------|------------|------------|
| | RO 60 | FOD 95 | → Page 119 | → Page 119 | → Page 119 | → Page 119 |
| DACROMET® | - | FOD 95 ZD | FOD 10 ZD | → Page 119 | → Page 119 | → Page 119 |

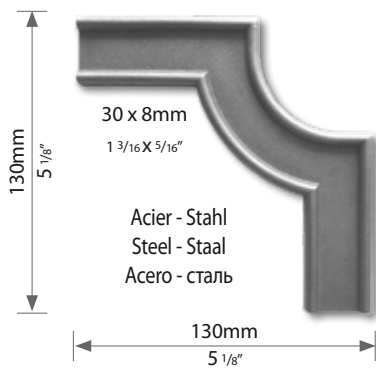

BCLA 38

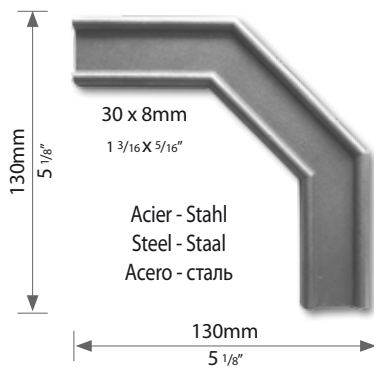

BCLB 38

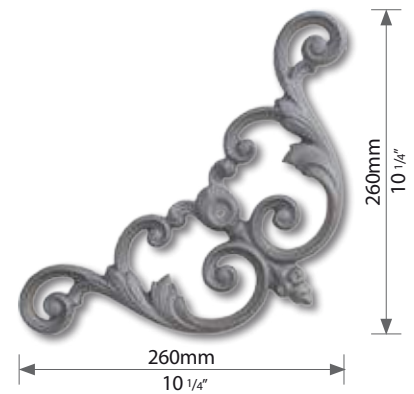

| | |
|-----------|------------|
| | → Page 119 |
| DACROMET® | → Page 119 |

FONTE

Exemples d'utilisation
Anwendungsbeispiele
For illustration purposes only
Voorbeeld voor toepassing
Ejemplos de empleo
Примеры использования



ALUMINIUM

ALUMINIUM

FRANÇAIS : Ces poteaux, barreaux et éléments décoratifs sont entièrement en aluminium

DEUTSCH : Diese Pfosten, Stangen und Dekorationselemente bestehen vollständig aus Aluminium

ENGLISH : These posts, bars and decorative elements are entirely made of aluminum

NEDERLANDS : Deze palen, staven en decoratieve elementen zijn volledig gemaakt van aluminium

ESPAÑOL : Estos postes, barras y elementos decorativos están hechos completamente de aluminio.

RUSSE : Эти столбы, решетки и декоративные элементы полностью изготовлены из алюминия

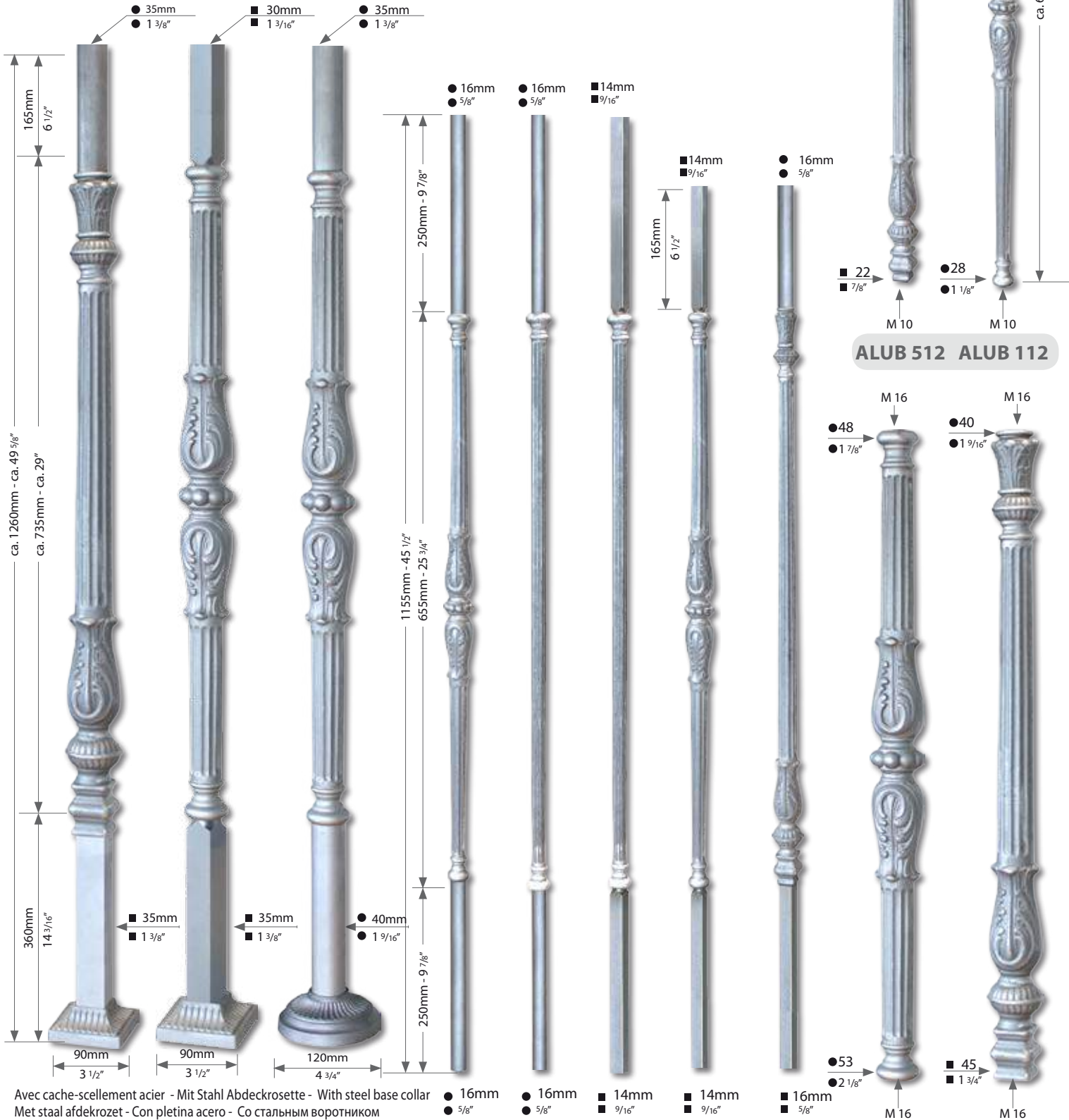

ALUP 555 ALUP 333 ALUP 111 ALUB115 ALUB915 ALUB933 ALUB133 ALUB515 ALUP 110 ALUP 550

SIMPLE FACE - EINSEITIG
ПРОСТОЕ ЛИЦО



ALUD 27

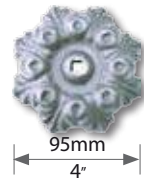

ALUD 95



ALUD 10



ALUD 7



ALUD 11

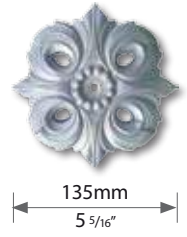

ALUD 13

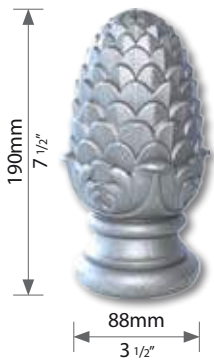

M12 ALUT 19



M12 ALUT 15



M10 ALUT 12

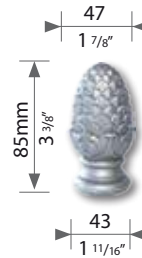

M10 ALUT 8



M8 ALUT 7

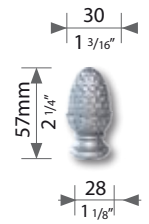

M8 ALUT 6

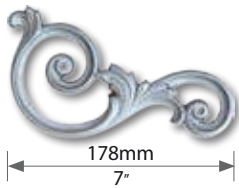

ALUD 18 L

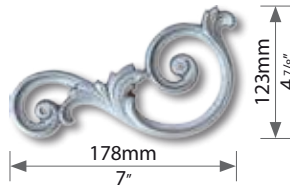

ALUD 18 R

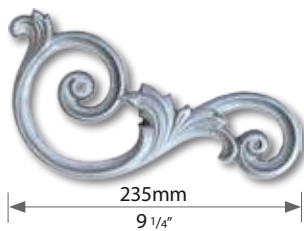

ALUD 24 L

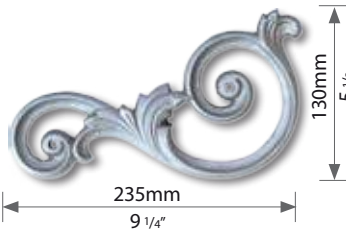

ALUD 24 R

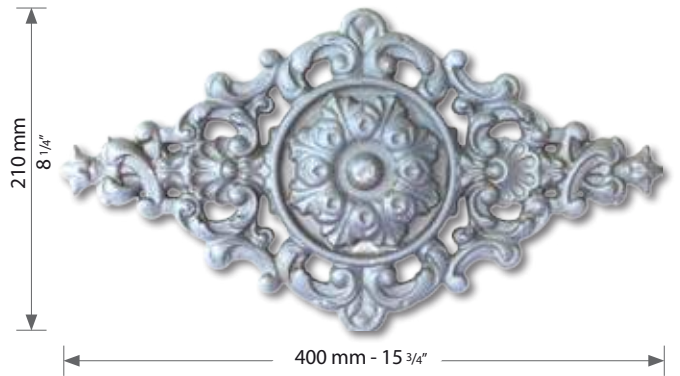

ALUD 400



ALUD 60

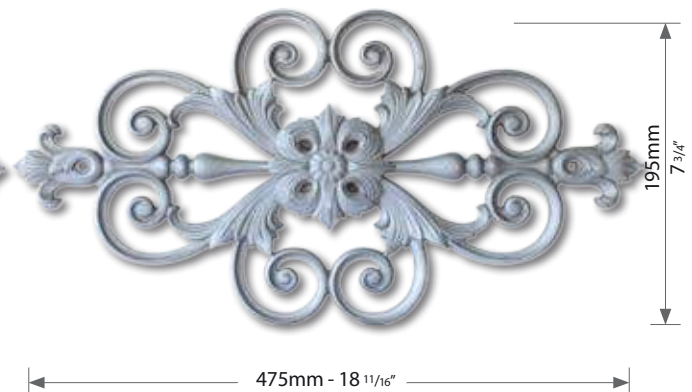

ALUD 45



FER

BLACK SERIES

FRANÇAIS : Découvrez la nouvelle gamme Black Diamond et laissez-vous séduire par sa sobriété et son élégance. Les cristaux centraux sont estampillés Swarovski. Le corps du barreau est en acier peint noir mat.

DEUTSCH : Lassen Sie sich von der neuen Reihe Black Diamond überraschen und von ihrer Mäßigkeit und Eleganz verführen. Die Kristalle sind mit einem Echtheitszeichen Swarovski versehen. Der Stab an sich ist in Stahl mattschwarz gestrichen.

ENGLISH : Discover the new series Black Diamond whose graceful design and elegance will appeal to you. The central crystals are made by Swarovski. The body of the baluster is raw steel painted matt black.

NEDERLANDS : Ontdek de nieuwe Black Diamond serie, waarvan de sierlijke vormgeving en elegantie u zal aanspreken. De kristallen worden gemaakt door Swarovski. De basis van de balusters zijn gemaakt van onbehandeld metaal.

ESPAÑOL : Descubra la nueva gama Black Diamond y déjese seducir por su sobriedad y elegancia. Los cristales centrales son de la marca Swarovski. El cuerpo del barrote es de acero pintado en negro mate.

RUSSE : Откройте для себя новую серию «ЧЁРНЫЙ БРИЛЛИАНТ» и позвольте ей соблазнить Вас своей сдержанностью и изяществом. Центральные кристаллы имеют клеймо SWAROVSKI. Корпус покрыт чёрной матовой краской.



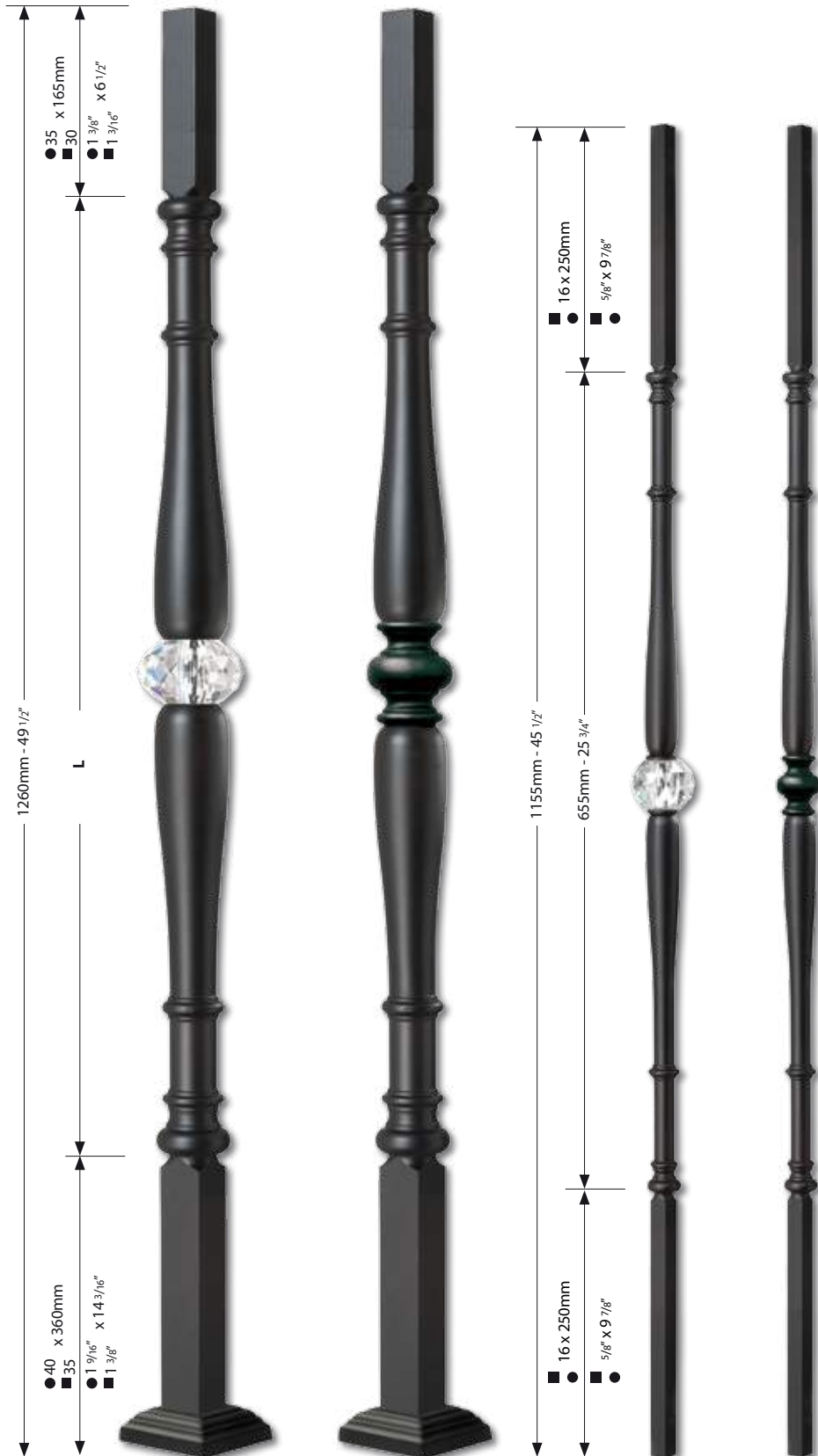

ø 100mm
H: 140mm



ø 4"
H: 5 1/2"

M10
BDT 35

ø 100mm
H: 140mm



ø 4"
H: 5 1/2"

M10
BDT 30



43mm
1 3/4"
120mm
4 3/4"

● 40 mm
1 5/8" **BD CS 224**



A

| | | |
|------------------|------------------------|----------------|
| ● 14 mm 9/16" | A = 53mm A = 2 1/8" | BD CS 4 |
| ● 16 mm 5/8" | A = 53mm A = 2 1/8" | BD CS 6 |
| ● 16 mm 5/8" | A = 63mm A = 2 1/2" | BD CS 7 |

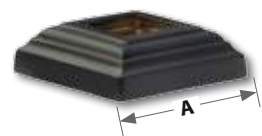

A

| | | |
|------------------|------------------------|-----------------|
| ■ 16 mm 5/8" | A = 60mm A = 2 3/8" | BD CS616 |
| ■ 25mm 1" | A = 85mm A = 3 3/8" | BD CS825 |
| ■ 35mm 1 3/8" | A = 85mm A = 3 3/8" | BD CS835 |

| | | | | | |
|--------------------------|------------------|--------------------------|------------------|------------------|------------------|
| ■ L= 705mm L= 27 3/4" | BD P700 K | L= 735mm L= 28 15/16" | BD P710 K | BD B724 K | BD B734 K |
| ● L= 705mm L= 27 3/4" | BD P700 R | L= 735mm L= 28 15/16" | BD P710 R | BD B724 R | BD B734 R |

FER

BLACK TIGER EYE

BDP700K-TE **BDP710K** **BDB724K-TE** **BDB734K**

BDP700R-TE **BDP710R** **BDB724R-TE** **BDB734R**

BDT30-TE

BD CS 224

BD CS4 **BD CS6** **BD CS7**

BD CS616 **BD CS825** **BD CS835**

Dimensions:

- BDP700K-TE: 1260mm - 49 1/2" (Total), 35 x 165mm (Top), 40 x 360mm (Base)
- BDP710K: 1155mm - 45 1/2" (Total), 655mm - 25 3/4" (Middle)
- BDB724K-TE: 1155mm - 45 1/2" (Total), 655mm - 25 3/4" (Middle)
- BDB734K: 1155mm - 45 1/2" (Total), 655mm - 25 3/4" (Middle)

Finial Dimensions:

- BDT30-TE: ø 100mm (140mm H), ø 4" (5 1/2" H), ø 54mm (2 1/8" ø)
- BD CS 224: 43mm (1 3/4" H), 120mm (4 3/4" W), 40mm (1 5/8" ø)
- BD CS4: 14mm (9/16" H), A = 53mm (2 1/8" W)
- BD CS6: 16mm (5/8" H), A = 53mm (2 1/8" W)
- BD CS7: 16mm (5/8" H), A = 63mm (2 1/2" W)
- BD CS616: 16mm (5/8" H), A = 60mm (2 3/8" W)
- BD CS825: 25mm (1" H), A = 85mm (3 3/8" W)
- BD CS835: 35mm (1 3/8" H), A = 85mm (3 3/8" W)

BLACK GREEN ONYX

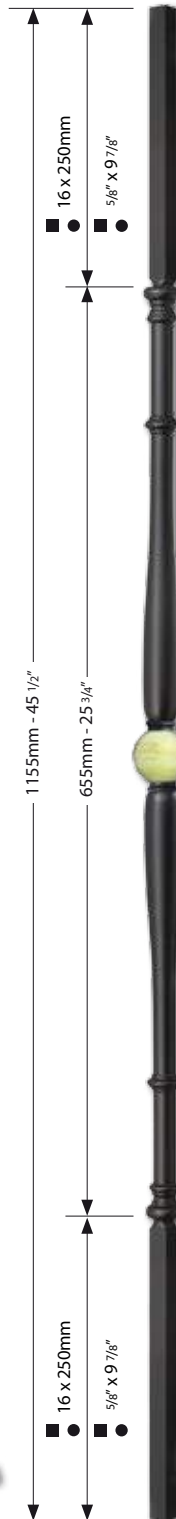
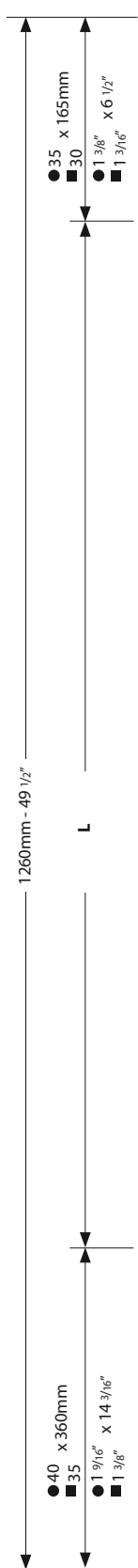

M10

BDT30-GO



● 40 mm
1 5/8" **BD CS 224**



A

| | | |
|------------------|------------------------|---------------|
| ● 14 mm 9/16" | A = 53mm A = 2 1/8" | BD CS4 |
| ● 16 mm 5/8" | A = 53mm A = 2 1/8" | BD CS6 |
| ● 16 mm 5/8" | A = 63mm A = 2 1/2" | BD CS7 |

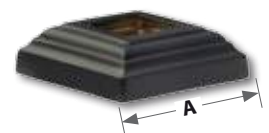

| | | |
|------------------|------------------------|-----------------|
| ■ 16 mm 5/8" | A = 60mm A = 2 3/8" | BD CS616 |
| ■ 25mm 1" | A = 85mm A = 3 3/8" | BD CS825 |
| ■ 35mm 1 3/8" | A = 85mm A = 3 3/8" | BD CS835 |

| | | | | |
|----------------------------|-------------------|----------------|-------------------|----------------|
| ■ L = 705mm L = 27 3/4" | BDP700K-GO | BDP710K | BDB724K-GO | BDB734K |
| ● L = 705mm L = 27 3/4" | BDP700R-GO | BDP710R | BDB724R-GO | BDB734R |

FER

BLACK LABRADORITE

Necklaces:
 - Total length: 1260mm - 49 1/2"
 - Sphere diameter: 35 x 165mm
 - Sphere height: 30
 - Sphere diameter: 1 3/8" x 6 1/2"
 - Sphere height: 1 3/16"

Pendants:
 - Total length: 1155mm - 45 1/2"
 - Sphere diameter: 16 x 250mm
 - Sphere height: 5/8" x 9 7/8"
 - Total length: 655mm - 25 3/4"
 - Sphere diameter: 16 x 250mm
 - Sphere height: 5/8" x 9 7/8"

Earrings:
 - Total length: 40 x 360mm
 - Sphere diameter: 35
 - Sphere height: 1 9/16" x 1 14 3/16"
 - Sphere diameter: 1 3/8" x 1 3/16"

Labradorite Sphere (M10):
 - Diameter: 100mm
 - Height: 140mm
 - Diameter: 4"
 - Height: 5 1/2"
 - Diameter: 54mm
 - Diameter: 2 1/8"

Labradorite Sphere (BD CS 224):
 - Diameter: 43mm
 - Height: 1 3/4"
 - Diameter: 120mm
 - Diameter: 4 3/4"

Labradorite Sphere (BD CS 4, 6, 7):
 - Diameter: 14mm (9/16") A = 53mm (2 1/8") BD CS 4
 - Diameter: 16mm (5/8") A = 53mm (2 1/8") BD CS 6
 - Diameter: 16mm (5/8") A = 63mm (2 1/2") BD CS 7

Labradorite Sphere (BD CS 616, 825, 835):
 - Diameter: 16mm (5/8") A = 60mm (2 3/8") BD CS 616
 - Diameter: 25mm (1") A = 85mm (3 3/8") BD CS 825
 - Diameter: 35mm (1 3/8") A = 85mm (3 3/8") BD CS 835

| | | | | |
|----------------------------|-------------------|----------------|-------------------|----------------|
| ■ L = 705mm L = 27 3/4" | BDP700K-LA | BDP710K | BDB724K-LA | BDB734K |
| ● L = 705mm L = 27 3/4" | BDP700R-LA | BDP710R | BDB724R-LA | BDB734R |



PRESTIGE

FRANÇAIS : Le couronnement dans la finition des balustres "PRESTIGE" réside dans la touche finale apportée par la main de l'artiste patineur, faisant ressortir l'harmonie des formes ainsi que le modelé du métal. Après vernissage, ils sont emballés sous un solide film plastique qui doit rester en place jusqu'à la fin des travaux. Les extrémités supérieures et inférieures sont brutes permettant ainsi une mise en œuvre facile (coupe - soudure à l'arc - meulage - etc.). Ces extrémités ainsi que les lisses hautes et basses sont à peindre dans une peinture mate, assortie à la patine. Ces balustres sont conçus exclusivement pour l'intérieur. Produits conçus exclusivement pour l'intérieur.

DEUTSCH : Fertig lackierte und patinierte Zierstäbe. Durch die Patinierung wird die Arbeit besonders hervorgehoben. Nach der Lackierung werden die lackierten Teile der Stäbe mit einer starken Plastikfolie verpackt, die erst nach Beendigung der Montage des Gitters entfernt wird. Die Endstücke der Stäbe sind roh und können nach Verarbeitung problemlos nachlackiert werden. Es wird empfohlen, für die Lackierung der Anschlußteile einen seidenmatten Lack zu verwenden. Verwendung ausschließlich für den Innenbereich. Wir empfehlen diese Teile nur für den Innenbereich zu verwenden.

ENGLISH : The finish of the "PRESTIGE" balusters is artistically hand-patinated bringing out the harmony of the lines as well as the relief of the metal. After varnishing, they are packaged in a strong plastic film, which should be kept on until work is completed. The upper and lower ends are delivered raw, unfinished, to facilitate cutting, welding, grinding... Both ends and rails should be painted with a dull paint, suiting the patina. Balusters for indoor use only. Items for indoor use only.

NEDERLANDS : De kroon van de perfecte voltooiing van de "PRESTIGE" spijlen ligt aan het handmatig patineren waardoor de vormen en reliëf mooier tot z'n recht komen. Na het lakken worden deze spijlen in sterk plastic folie verpakt. De boven- en onderstukken zijn niet behandeld, i.v.m. verdere verwerking van de spijlen (zagen, lassen, etc.). Beide eindstukken zijn met een passende kleur te lakken. Gebruik : uitsluitend voor interieurs.

ESPAÑOL : La culminación en el acabado de los balaustres "PRESTIGE" radica en el toque final aportado por la mano del artista patinador, haciendo resaltar la armonía de las formas así como el modelado del metal. Después del lacado, se ambalan bajo una sólida película de plástico que debe permanecer en su sitio hasta la total terminación de los trabajos. Los extremos superiores e inferiores están en bruto permitiendo de esta forma un fácil mecanizado (corte-soldadura al arco-amolado-etc.). Estos extremos, así como los cinturones superiores e inferiores, deben pintarse con una pintura mate, a juego con la patina. Estos balaustres están concebidos exclusivamente para interiores. Productos exclusivamente para el interior.

RUSSE : Художественная ручная роспись стоек (балайсин) серии ПРЕСТИЖ обеспечивает гармонию линий и подчёркивает рельеф металла. После покрытия лаком изделия упаковывают в прочную пластиковую плёнку, которую не следует снимать до окончания монтажа. Для облегчения сборочных операций (обрезки, сварки, шлифовки...), верхние и нижние концы стоек не обработаны и не покрашены. Нижние и верхние окончания окрашивают матовой краской с патиной. Стойки предназначены для установки внутри помещений.



ID

Ivoire Doré - Elfenbein Goldfarbig
Ivory Gold Colored - Ivoorkleurig Gold
Marfil Dorado - Позолоченная слоновая кость

BA

Bronze Antique - Antik Bronze
Antic Bronze - Antic Brons
Bronce viejo - Античная бронза

FN

Fer Naturel - Eisen natur
Natural steel - Naturel-Metaalkleur
Hierro natural - Натуральное железо

OR

Or - Goldfarbig
Gold - Of
Oro - Золото

VB

Vieux Bronze - Alt Bronze
Old bronze - Oud brons
Bronce viejo - Состаренная бронза

PRESTIGE

- * FINITIONS DISPONIBLES: A PRECISER AU MOMENT DE LA COMMANDE .
- * LIEFERBARE FERTIGUNGEN BITTE BEI DER BESTELLUNG ANGEBEN.
- * PLEASE CHOOSE THE FINISH AT TIME OF ORDERING.
- * DE GEWENSTE AFWERKING BIJ UW BESTELLING DOORGEVEN.
- * LOS ACABADOS DISPONIBLES SE INDICAN AL HACER EL PEDIDO.
- * ВОЗМОЖНЫЕ ВАРИАНТЫ ОТДЕЛКИ: ПРОСЬБА УТОЧНЯТЬ В МОМЕНТ ОФОРМЛЕНИЯ ЗАКАЗА.

LA FINITION «FN» EST UTILISÉE SUR TOUTE LA PAGE: PR719 FN, B7109 FN, ETC.
 AUF DER GANZEN SEITE IST DIE FERTIGUNG « FN » ANGEWANDT : PR719FN, B7109FN, USW.
 THE FINISH « FN » IS USED FOR EVERY ITEM ON THIS PAGE : PR719FN, B7109FN, ETC.
 OP DEZE PAGINA WORDT DE AFWERKING « FN » TOEGEPAST : PR719FN, B7109FN, ETC.
 EL ACABADO «FN» SE UTILIZA EN TODA LA PÁGINA: PR719FN, B7109FN, ETCÉTERA.
 ВСЕ ЭЛЕМЕНТЫ ПРЕДСТАВЛЕННЫЙ НА ЭТОЙ СТРАНИЦЕ ИМЕЮТ ОТДЕЛКУ "FN": PR719 FN, B7109 FN И
 ТАК ДАЛЕЕ

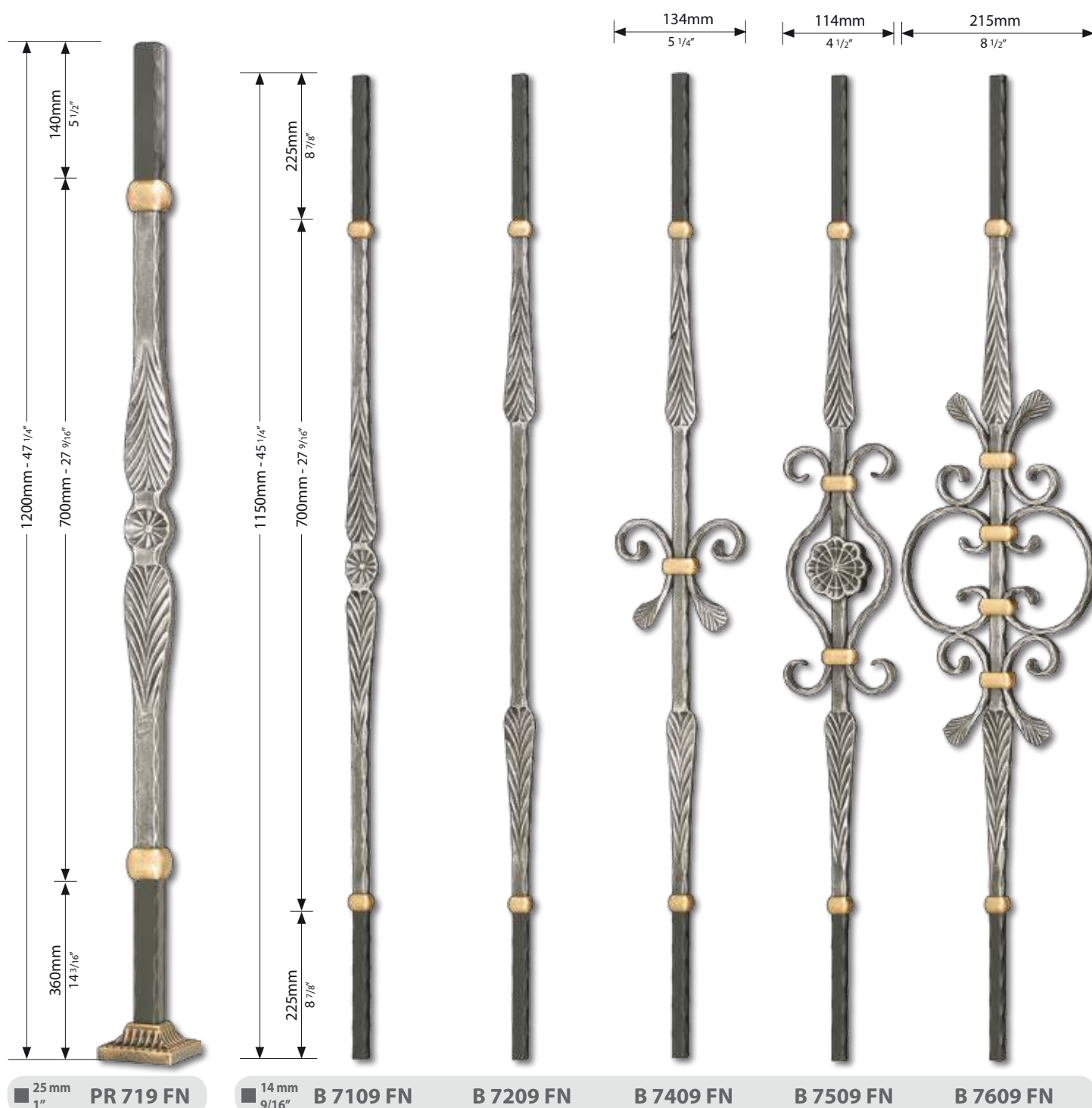

FER

PRESTIGE

* FINITIONS DISPONIBLES: A PRECISER AU MOMENT DE LA COMMANDE .

* LIEFERBARE FERTIGUNGEN BITTE BEI DER BESTELLUNG ANGEBEN.

* PLEASE CHOOSE THE FINISH AT TIME OF ORDERING.

* DE GEWENSTE AFWERKING BIJ UW BESTELLING DOORGEVEN.

* LOS ACABADOS DISPONIBLES SE INDICAN AL HACER EL PEDIDO.

* ВОЗМОЖНЫЕ ВАРИАНТЫ ОТДЕЛКИ: ПРОСЬБА УТОЧНЯТЬ В МОМЕНТ ОФОРМЛЕНИЯ ЗАКАЗА.

LA FINITION «VB» EST UTILISÉE SUR TOUTE LA PAGE: B3609 VB, B0109 VB, ETC.

AUF DER GANZEN SEITE IST DIE FERTIGUNG « VB » ANGEWANDT : B3609 VB, B0109 VB, USW.

THE FINISH « VB » IS USED FOR EVERY ITEM ON THIS PAGE : B3609 VB, B0109 VB, ETC.

OP DEZE PAGINA WORDT DE AFWERKING « VB » TOEGEPAST : B3609 VB, B0109 VB, ETC.

EL ACABADO «VB» SE UTILIZA EN TODA LA PÁGINA: B3609 VB, B0109 VB, ETCÉTERA.



PRESTIGE

FRANCE
gf
1948

- * FINITIONS DISPONIBLES: A PRECISER AU MOMENT DE LA COMMANDE .
- * LIEFERBARE FERTIGUNGEN BITTE BEI DER BESTELLUNG ANGEBEN.
- * PLEASE CHOOSE THE FINISH AT TIME OF ORDERING.
- * DE GEWENSTE AFWERKING BIJ UW BESTELLING DOORGEVEN.
- * LOS ACABADOS DISPONIBLES SE INDICAN AL HACER EL PEDIDO.
- * ВОЗМОЖНЫЕ ВАРИАНТЫ ОТДЕЛКИ: ПРОСЬБА УТОЧНЯТЬ В МОМЕНТ ОФОРМЛЕНИЯ ЗАКАЗА.

LA FINITION «VB» EST UTILISÉE SUR TOUTE LA PAGE: B3609 VB, B0109 VB, ETC.
AUF DER GANZEN SEITE IST DIE FERTIGUNG « VB » ANGEWANDT : B3609 VB, B0109 VB, USW.
THE FINISH « VB » IS USED FOR EVERY ITEM ON THIS PAGE : B3609 VB, B0109 VB, ETC.
OP DEZE PAGINA WORDT DE AFWERKING « VB » TOEGEPAST : B3609 VB, B0109 VB, ETC.
EL ACABADO «VB» SE UTILIZA EN TODA LA PÁGINA: B3609 VB, B0109 VB, ETCÉTERA.
ВСЕ ЭЛЕМЕНТЫ ПРЕДСТАВЛЕННЫЙ НА ЭТОЙ СТРАНИЦЕ ИМЕЮТ ОТДЕЛКУ"VB": B3609 VB, B0109 VB И ТАК ДАЛЕЕ.



B 1809 VB



B 0109 VB



B 0209 VB



FOB 109 VB



FRANÇAIS : Balustre "PRESTIGE" dans son emballage plastique, qui doit rester en place jusqu'à la fin des travaux.

DEUTSCH : "PRESTIGE" Zierstab in Plastikfolie verpackt, die erst nach Beendigung der Montage entfernt wird.

ENGLISH : "PRESTIGE" baluster in its plastic wrapper which should be kept on until installation has been completed.

NEDERLANDS : "PRESTIGE" sierspijlen zijn in plastic folie verpakt, die pas na montage verwijderd mag worden.

ESPAÑOL : Balaustre "PRESTIGE" en su envoltorio de plástico, que debe permanecer en su sitio hasta la total terminación de los trabajos.

RUSSE : Стойки ПРЕСТИЖ поставляются в пластиковой упаковке, которую не следует снимать до окончания монтажа.

FER

14 mm
9/16"

PRESTIGE

LA FINITION «ID» EST UTILISÉE SUR TOUTE LA PAGE: PS 129 ID, SUP 99 ID, ETC.
 AUF DER GANZEN SEITE IST DIE FERTIGUNG «ID» ANGEWANDT: PS 129 ID, SUP 99 ID, USW.
 THE FINISH «ID» IS USED FOR EVERY ITEM ON THIS PAGE: PS 129 ID, SUP 99 ID, ETC.
 OP DEZE PAGINA WORDT DE AFWERKING «ID» TOEGEPAST: PS 129 ID, SUP 99 ID, ETC.
 EL ACABADO «ID» SE UTILIZA EN TODA LA PÁGINA: PS 129 ID, SUP 99 ID, ETCÉTERA.
 ВСЕ ЭЛЕМЕНТЫ ПРЕДСТАВЛЕННЫЕ НА ЭТОЙ СТРАНИЦЕ ИМЕЮТ ОТДЕЛКУ «ID»: PS 129 ID, SUP 99 ID И ТАК ДАЛЕЕ.

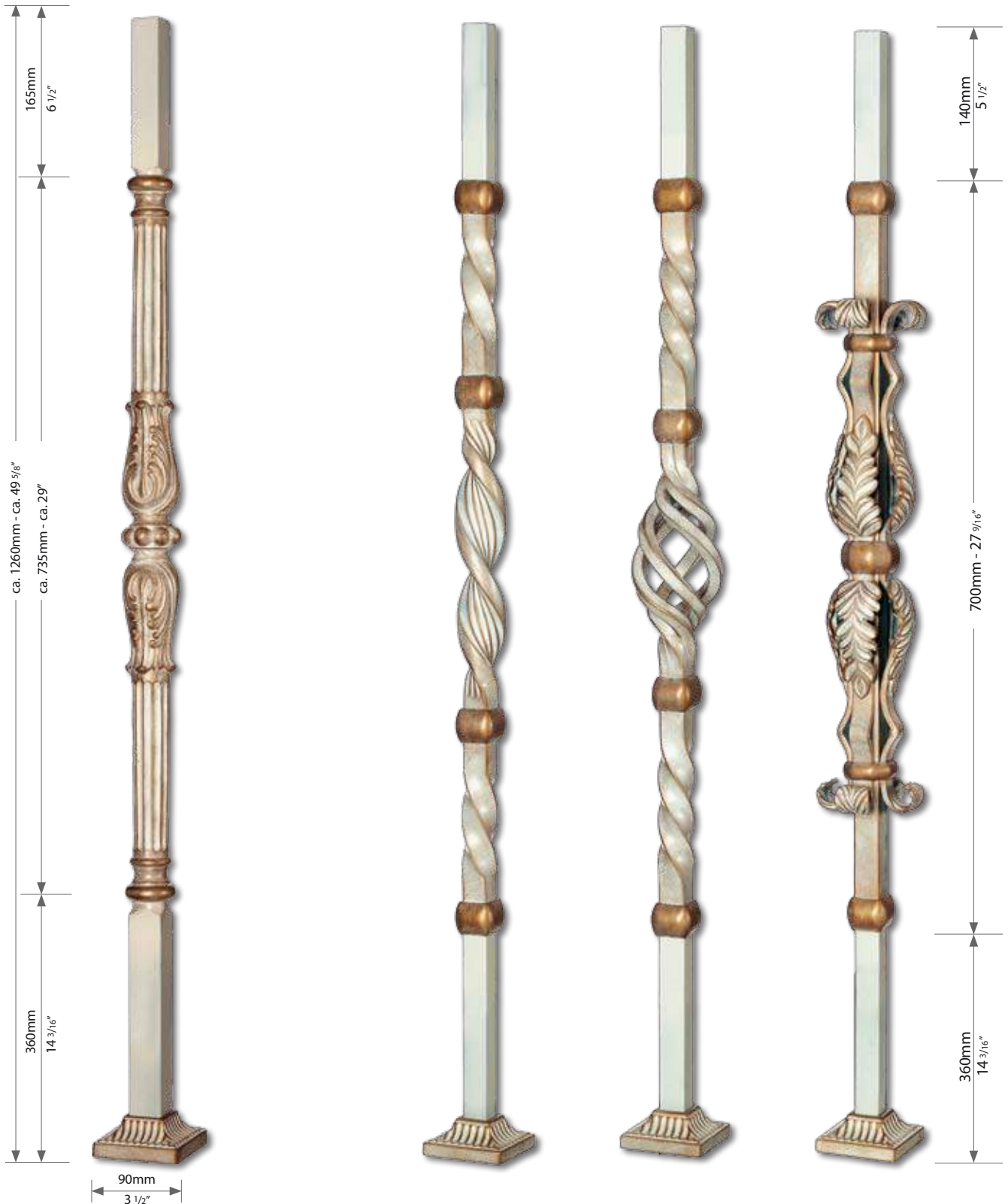

■ 35mm
1 3/8"

FOP 119 ID

■ 25mm
1"

P 129 ID

PS 129 ID

P 159 ID

PRESTIGE

Support en fer - Stahlträger mit ovalen Bohrungen
Steel bracket - Sierspildrager uit staal
Soporte de hierro - Боковое крепление из стали

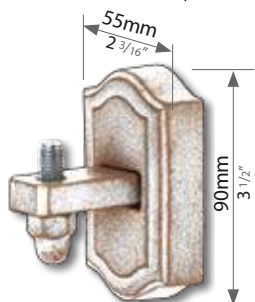

SUP 99 ID

Equerre en acier moulé - Sscmiedeguß Winkel
Steel angle bracket - Vierkante hoekijzer
Escuadra de acero moldeado
Кронштейн литой из стали

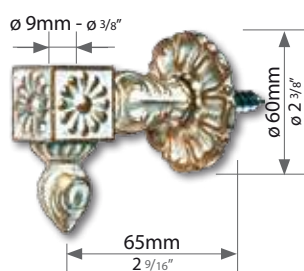

SUP 69 ID



FRANÇAIS : Têtes de départ sur embase, au choix pour extrémité, angle ou passage.
DEUTSCH : Zieraufsätze montiert auf einen Sockel. Zur Wahl Anfangs-, Winkel- oder durchlassender Sockel.
ENGLISH : Finials mounted on a base. To choose between extremity, angle or passing base.
NEDERLANDS : Sierstukken gemonteerd op een basis. Voor begin- en hoekstukken en rechte delen.
ESPAÑOL : Cabezales de arranque sobre una base a elegir para extremo, ángulo o pasante.
RUSSE : Декоративные навершия на основании. на выбор: для торца, угла или прохода.

* FINITIONS DISPONIBLES: A PRECISER AU MOMENT DE LA COMMANDE.
* LIEFERBARE FERTIGUNGEN BITTE BEI DER BESTELLUNG ANGEBEN.
* PLEASE CHOOSE THE FINISH AT TIME OF ORDERING.
* DE GEWENSTE AFWERKING BIJ UW BESTELLING DOORGEVEN.
* LOS ACABADOS DISPONIBLES SE INDICAN AL HACER EL PEDIDO.
* ВОЗМОЖНЫЕ ВАРИАНТЫ ОТДЕЛКИ: ПРОСЬБА УТОЧНЯТЬ В МОМЕНТ ОРМЛЕНИЯ ЗАКАЗА.

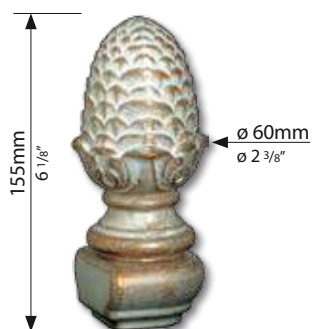

TF 129 ID

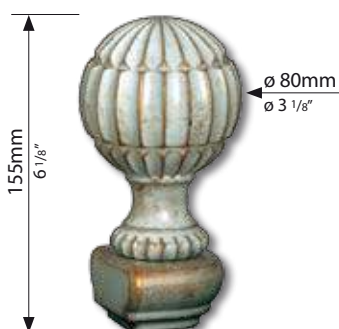

TS 209 ID

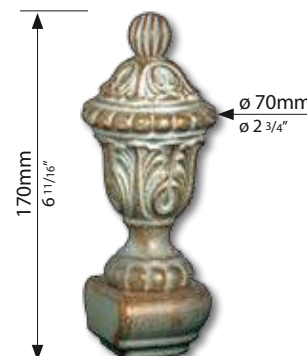

TF 139 ID

| | | | | | |
|--------------------------------------|------------------|--|------------------|---------------------------------------|------------------|
| Embase d'extrémité Extremity base | TF 129 ID | Anfangssockel Begindeel | TS 209 ID | Base de extremo Торцевое основание | TF 139 ID |
| Embase d'angle Base for angle | TF 529 ID | Winkelsockel Hoekstuk | TS 509 ID | Base de ángulo Угловое основание | TF 539 ID |
| Embase passante Passing base | TF 629 ID | Durchlassender Sockel Doorlopend deel | TS 609 ID | Base passante Проходное основание | TF 639 ID |

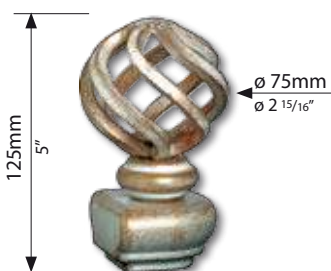

TZ 79 ID

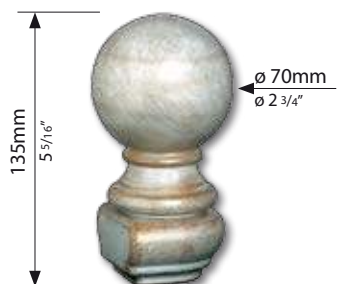

TF 79 ID

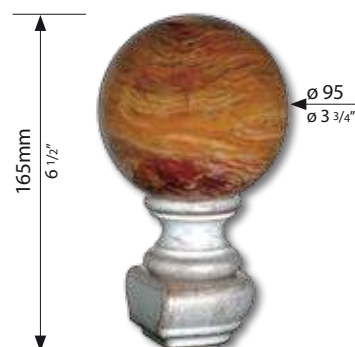

TP 89 ID

| | | | | | |
|--------------------------------------|-----------------|--|-----------------|---------------------------------------|-----------------|
| Embase d'extrémité Extremity base | TZ 79 ID | Anfangssockel Begindeel | TF 79 ID | Base de extremo Торцевое основание | TP 89 ID |
| Embase d'angle Base for angle | TZ 59 ID | Winkelsockel Hoekstuk | TF 59 ID | Base de ángulo Угловое основание | TP 59 ID |
| Embase passante Passing base | TZ 69 ID | Durchlassender Sockel Doorlopend deel | TF 69 ID | Base passante Проходное основание | TP 69 ID |

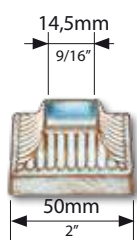

FOC 59 ID

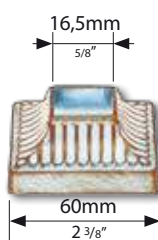

FOC 69 ID

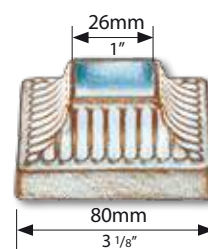

FOC 89 ID

RONDE

FRANÇAIS : Constituée de balustres et poteau en acier, usinés par tournage, la collection RONDE inspire une harmonie parfaite. Ses lignes arrondies, apportent un résultat moderne et une approche plus ludique aux espaces de vie. Vous pouvez combiner les barreaux de cette collection avec des matériaux chaleureux, tels que le bois, ou rester dans un registre plus industriel.

DEUTSCH : Aus Stahlgeländerpfosten und Stahlanfangspfosten zusammengestellt und durch Verdrehen bearbeitet, inspiriert die ROUND-Kollektion vollkommene Harmonie. Ihre abgerundeten Linien bringen den Wohnräumen ein moderneres Ergebnis und eine spielerischere Einstellung. Sie können diese Geländerpfosten der Kollektion mit wärmeren Materialien, wie zum Beispiel Holz, kombinieren, oder in einem industrielleren Register bleiben.

ENGLISH : Composed of steel balusters and steel starting posts, machined by turning, the ROUND collection inspires perfect harmony. Its rounded lines bring a modern result and a more playful approach to the living spaces. You can combine the balusters of this collection with warm materials, such as wood, or stay in a more industrial register.

NEDERLANDS : Samengesteld uit stalen balusters en stalen startposten, bewerkt door te draaien, de ROUND-collectie zorgt voor perfecte harmonie. De afgeronde lijnen zorgen voor een modern resultaat en een meer speelse benadering van de woonruimtes. Je kunt de balusters van deze collectie combineren met warme materialen, zoals hout, of in een meer industrieel register verblijven.

ESPAÑOL : Conformada de balaustres y postes de acero fabricados con proceso de torno, la colección RONDE inspira una armonía perfecta. Sus líneas redondeadas, dan un resultado moderno y una perspectiva más juguetona a los espacios vivos. Puede combinar las barandas de esta colección con materiales cálidos, como la madera, o permanecer en un registro más industrial.

RUSSE : Коллекция ROUND, созданная из стальных балясин и стальных пусковых элементов, обработанных с помощью токарной обработки, создает идеальную гармонию. Его округлые линии дают современный результат и более игривый подход к жилым помещениям. Вы можете комбинировать балясины этой коллекции с теплыми материалами, такими как дерево, или остаться в более промышленном регистре.

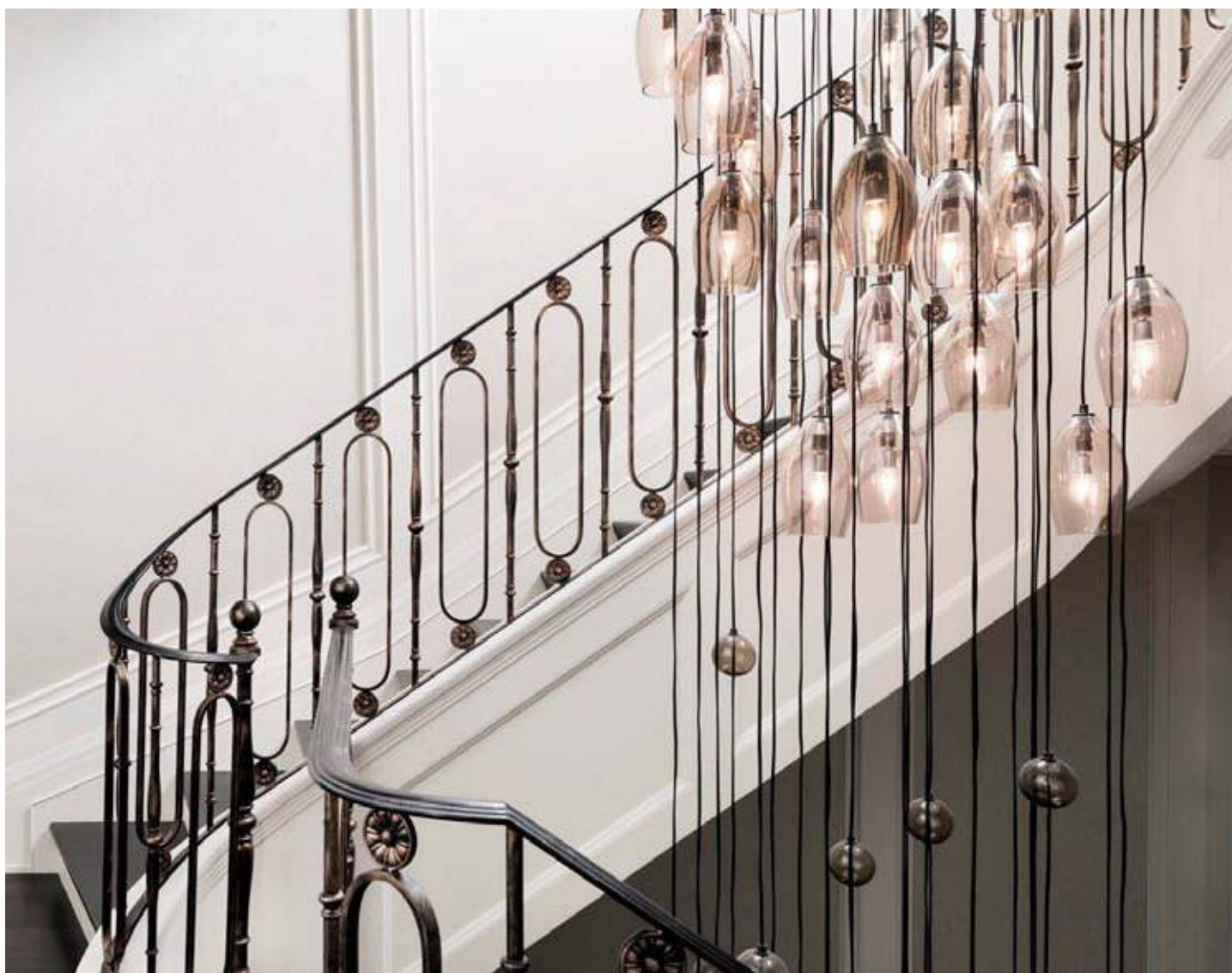

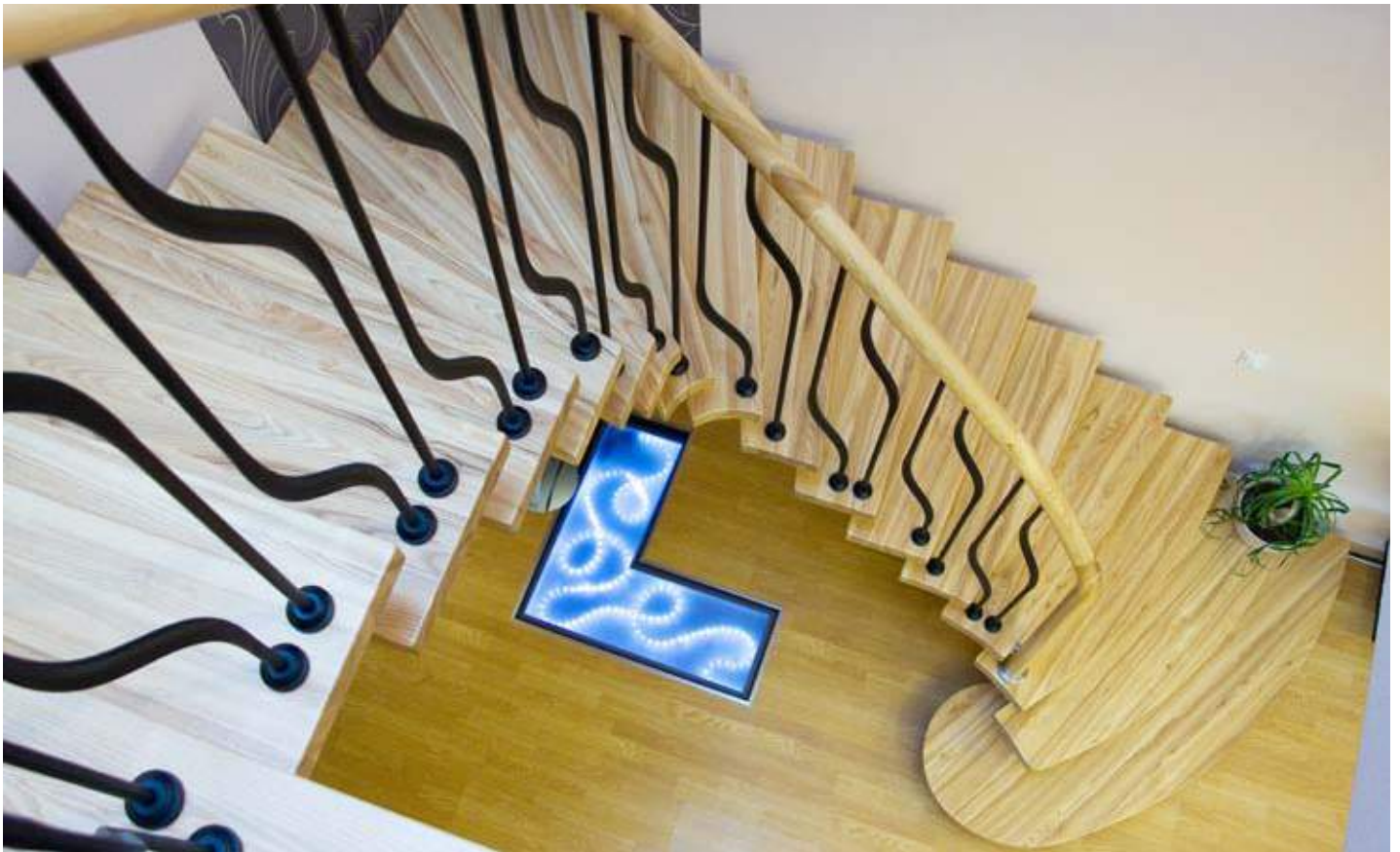

RONDE



| | | | | | |
|-----------------|---------------|---------------|---------------|---------------|---------------|
| ● 14mm 9/16" | BR 542 | BR 532 | BR 522 | BR 512 | BR 502 |
| ● 16mm 5/8" | BR 543 | BR 533 | BR 523 | BR 513 | BR 503 |

RONDE



Exemple d'utilisation Anwendungsbeispiel - Illustration
Voorbeelden voor toepassingen - Ejemplo de empleo
Пример использования

FRANÇAIS : Manchons en acier moulé.

DEUTSCH : Zierhülsen aus Schmiedeguß

ENGLISH : Decorative steel sleeves.

NEDERLANDS : Sierhulzen van gietstaal.

ESPAÑOL : Macollas en acero moldeado.

RUSSE : Муфты отлитые из стали.

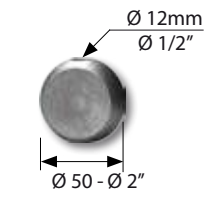

EG 551



EG 553

Exemple d'utilisation
Anwendungsbeispiel
Illustration
Voorbeelden voor toepassingen
Ejemplo de empleo
Пример использования

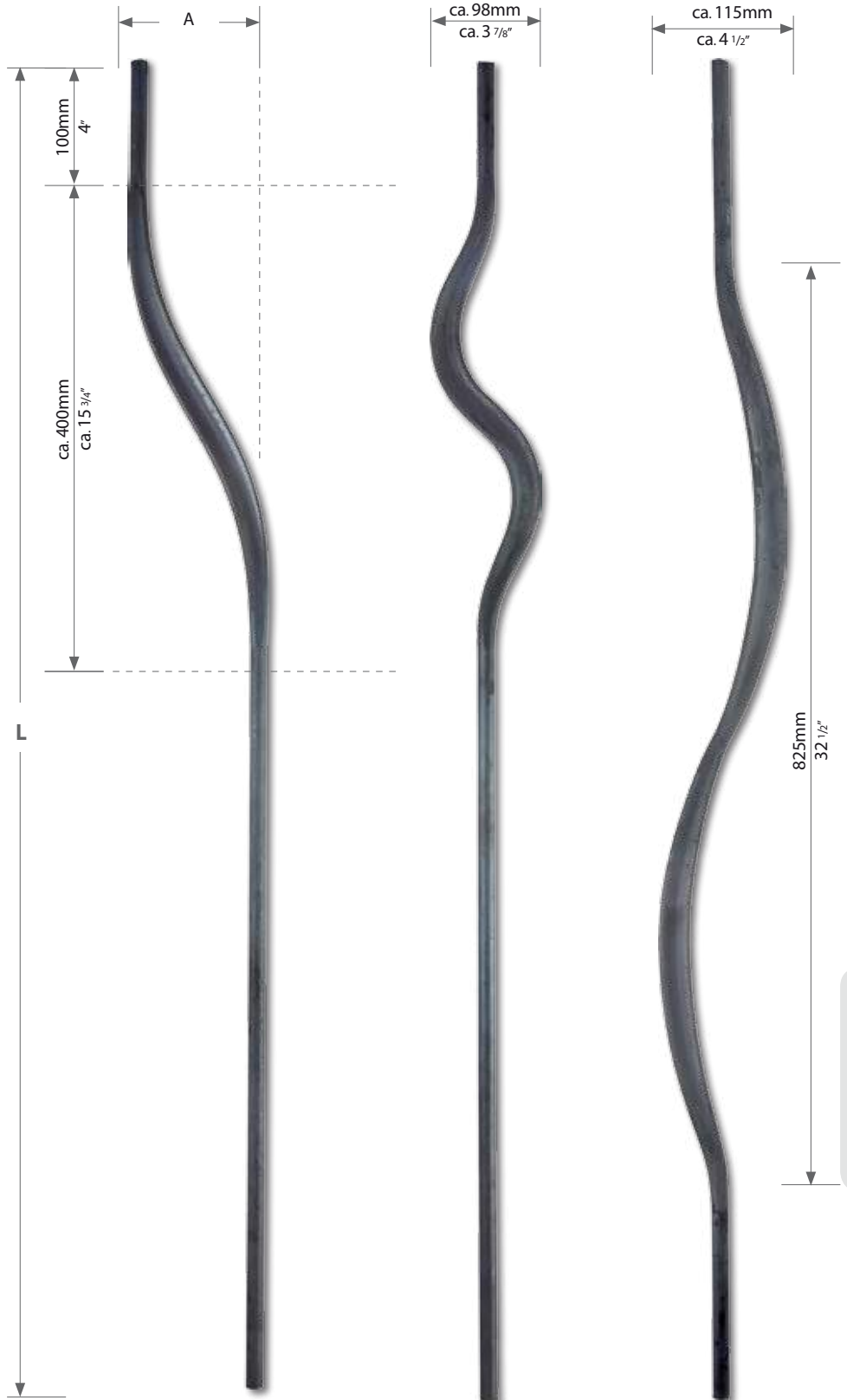

FER

| | | | | | |
|-------------------|----------------------------|--------------------------------|---------------|---------------|---------------|
| ● 14 mm 9/16" | L : 950 mm L : 37 3/8" | A : ca 110 mm A : ca 5 1/8" | B 5502 | B 5402 | B 5302 |
| ● 16 mm 5/8" | L : 1150 mm L : 45 1/4" | A : ca 115 mm A : ca 4 1/2" | B 5503 | B 5403 | B 5303 |
| ● 18 mm 11/16" | L : 1150 mm L : 45 1/4" | A : ca 140 mm A : ca 5 1/2" | B 5504 | B 5404 | - |

RONDE

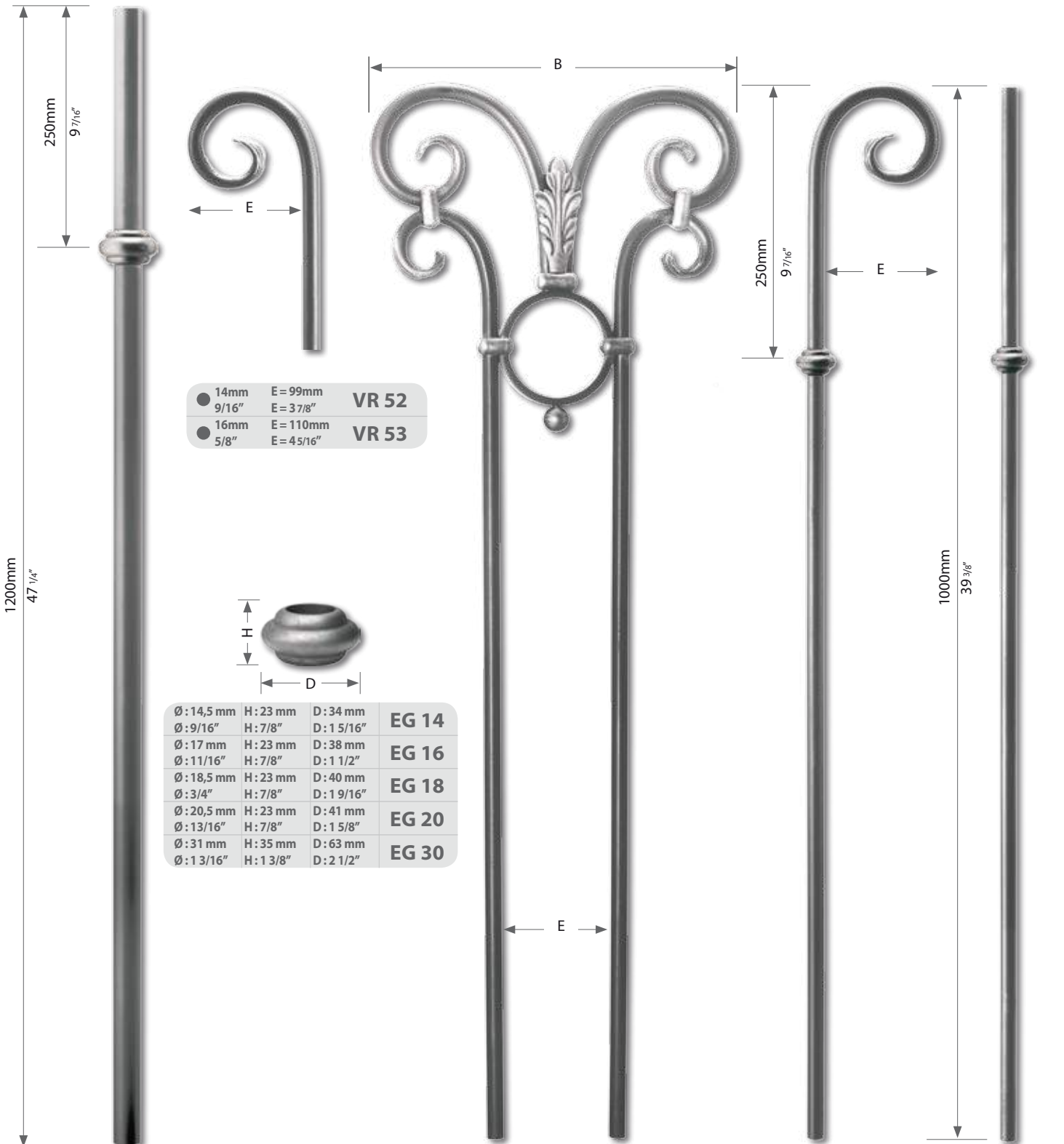

- 14mm E=99mm **VR 52**
9/16" E=3 7/8"
- 16mm E=110mm **VR 53**
5/8" E=4 5/16"

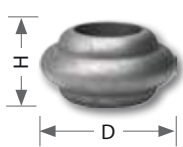

| | | | |
|-------------|------------|-------------|--------------|
| Ø : 14,5 mm | H : 23 mm | D : 34 mm | EG 14 |
| Ø : 9/16" | H : 7/8" | D : 1 5/16" | |
| Ø : 17 mm | H : 23 mm | D : 38 mm | EG 16 |
| Ø : 11/16" | H : 7/8" | D : 1 1/2" | |
| Ø : 18,5 mm | H : 23 mm | D : 40 mm | EG 18 |
| Ø : 3/4" | H : 7/8" | D : 1 9/16" | |
| Ø : 20,5 mm | H : 23 mm | D : 41 mm | EG 20 |
| Ø : 13/16" | H : 7/8" | D : 1 5/8" | |
| Ø : 31 mm | H : 35 mm | D : 63 mm | EG 30 |
| Ø : 1 3/16" | H : 1 3/8" | D : 2 1/2" | |

- 30mm **PR 565**
1 3/16"

| | | | |
|--------------------------|-------------------|-----------------------|---------------|
| ● 14mm E=99mm - 3 7/8" | BR 552 | E=99mm BR 562 | BR 572 |
| ● 16mm E=110mm - 4 5/16" | BR 553 | E=110mm BR 563 | BR 573 |
| | B=320mm - 12 5/8" | E=37/8" | |
| | B=355mm - 14" | E=45/16" | |

RONDE

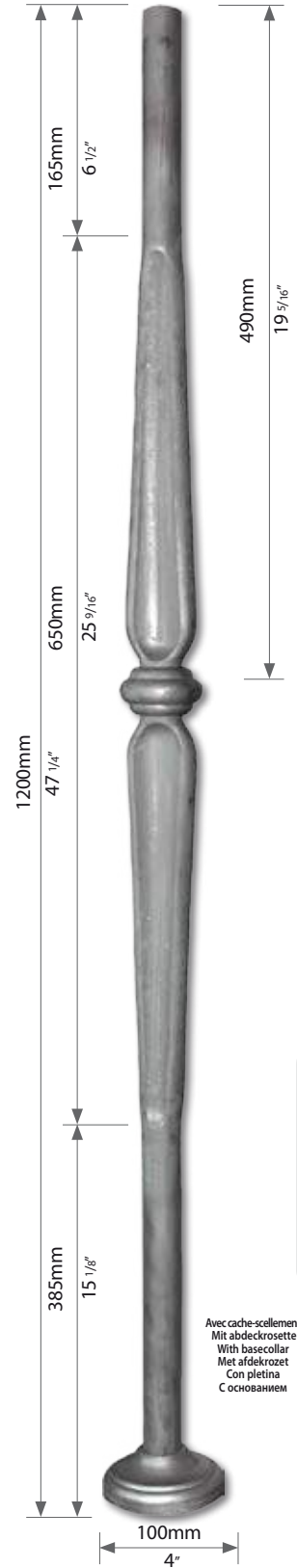
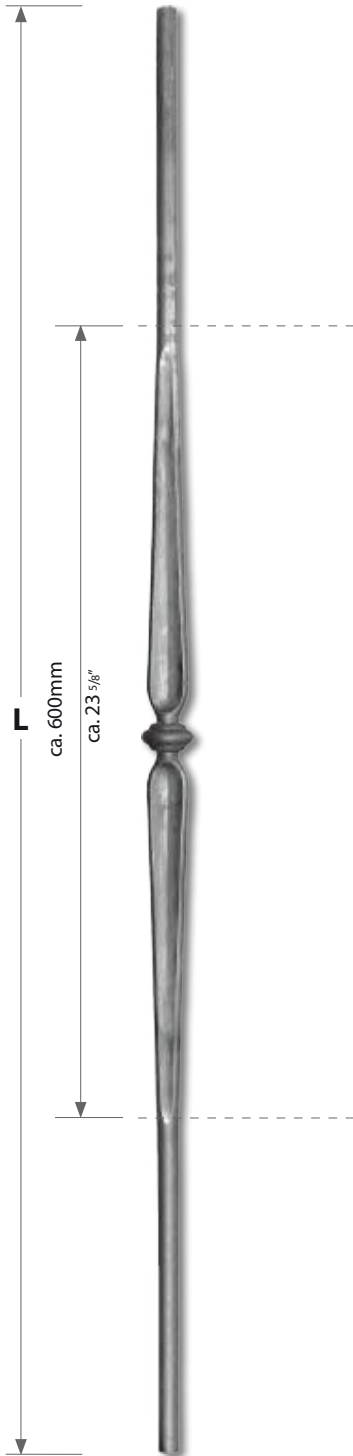

| | | | | | |
|-------------------|--------------------------|---------------|---------------|---------------|---------------|
| ● 14 mm 9/16" | L: 1000 mm L: 39 3/8" | BR 612 | BR 622 | BR 632 | BR 652 |
| ● 16 mm 5/8" | L: 1150 mm L: 45 1/4" | BR 613 | BR 623 | BR 633 | BR 653 |
| ● 18 mm 11/16" | L: 1150 mm L: 45 1/4" | BR 614 | BR 624 | - | - |

● 30 mm
1 3/16" **P 630**

Avec cache-scellement
Mit abdeckrossette
With basecollar
Met afdekrozet
Con pletina
С основанием

FER

RONDE

FRANÇAIS : Balustres et poteaux en acier, usinés par tournage. Toutes les parties en laiton sont polies et protégées par un vernis spécial. BL715, BL725, BL727, PL705 & PL707: Produits conçus exclusivement pour l'intérieur.

DEUTSCH : Zierstäbe und Pfosten aus Stahl, durch Dreharbeiten hergestellt. Die Messingteile sind poliert und lackiert. BL715, BL725, BL727, PL705 & PL707: Wir empfehlen diese Teile nur für den Innenbereich zu verwenden.

ENGLISH : Balusters and posts made of steel by lathe work. The brass pieces are polished and protected by a special lacquer.

BL715, BL725, BL727, PL705 & PL707: Items for indoor use.

NEEDERLANDS : Sierspijlen en -balusters vervaardigd middels draaiwerk. De messing delen zijn gepolijst en gelakt. BL715, BL725, BL727, PL705 & PL707: Gebruik: uitsluitend voor interieurs.

ESPAÑOL : Balaustres y arranques en acero, fabricados al torno. Todas las partes de latón están pulidas y protegidas con un barniz especial. BL715, BL725, BL727, PL705 & PL707: Productos exclusivamente para el interior.

RUSSE : Стальные стойки и столбы выточены на станке. Все латунные части отполированы и защищены специальным лаком.

Элементы: BL715, BL725, PL705, BL727 & PL707 предназначены для использования только в помещении.

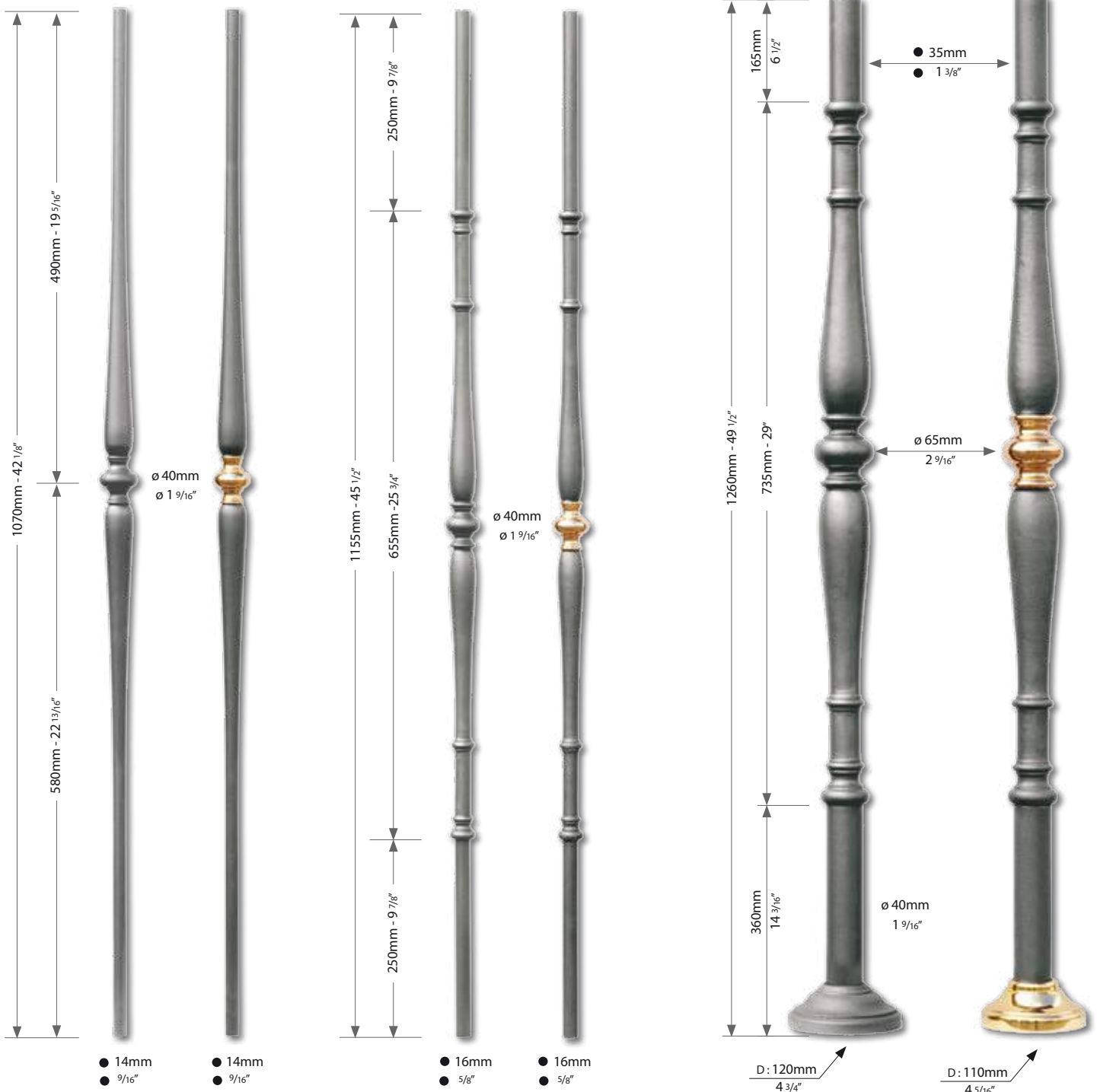

Avec cache-scèlement - Mit Abdeckkrosette - With basecollar - Met afdekrozet - Con pletina

B 714

BL 715

B 724

BL 725

P 700

PL 705

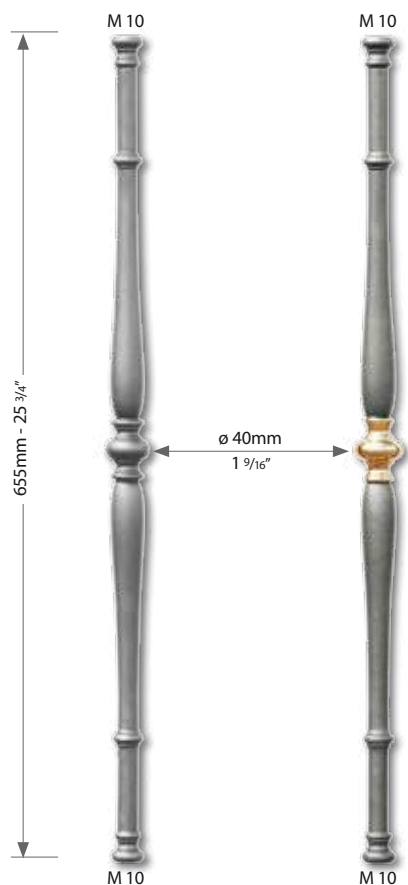

B 726

BL 727

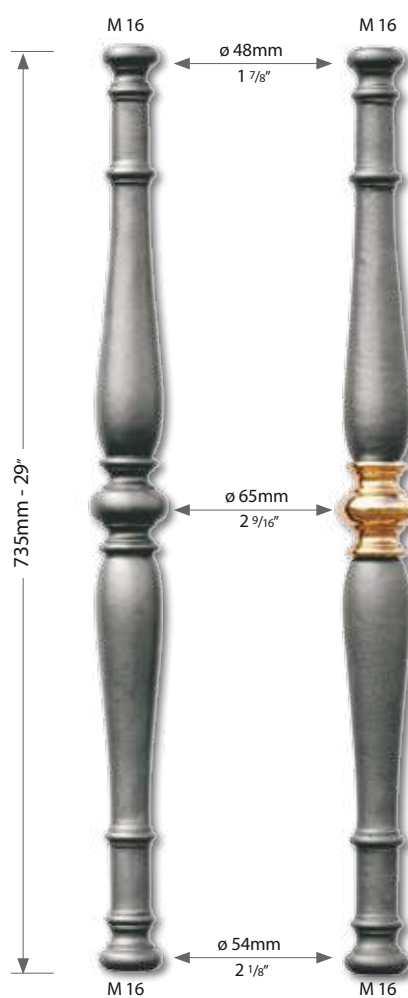

P 706

PL 707



FER

MOZART

FRANÇAIS : L'exercice de style prend ici tout son sens en mêlant avec élégance l'exubérance des feuillages et des fleurs ou d'un paon stylisé. Mozart vous invite à recréer la splendeur des ferronneries des anciens palais.

DISPONIBLE PATINÉ SUR DEMANDE.

DEUTSCH : Stilvolle Anordnung erreicht hier einen Höhepunkt mit einer eleganten Mischung aus üppigem Laub und Blumen oder mit einem stilisierten Pfau. Mozart lädt Sie ein, die Pracht der Schmiedekunst ehemaliger Palästen neu zu erschaffen. Verfügbar patiniert auf Anfrage.

LIEFERBAR PATINIERT AUF ANFRAGE.

ENGLISH : Stylistic composition takes on its full meaning in the Mozart line, elegantly combining the exuberance of leaves and flowers or of a stylized peacock." Mozart invites you to recreate the splendor of metalworks in ancient palaces.

AVAILABLE IN A PATINATED FINISH UPON REQUEST.

NEDERLANDS : Stijlvolle compositie bereikt hier haar hoogtepunt met een elegante mix van uitbundig loof en bloemen of met een gestileerde pauw. Mozart nodigt uit de pracht van de smeedkunst uit historische paleizen opnieuw te laten zien.

LEVERBAAR IN GEPATINEERDE UITVOERING OP AANVRAAG.

ESPAÑOL : El ejercicio de estilo toma aquí todo su sentido mezclando con elegancia la exuberancia de los follajes y de las flores o del pavo estilizado. Mozart le invita a recrear el esplendor de los cerrajeros de los antiguos palacios. Disponible en acabado patinado bajo pedido.

DISPONIBLE PATINADO BAJO PEDIDO.

RUSSE : Стильное исполнение, сочетающее в себе изящество и богатство листвы и цветов или стилизованного павлина. Серия «МОЦАРТ» поможет Вам воссоздать у себя всё великолепие ковки, украшающей старинные дворцы.

ВОЗМОЖЕН ЗАКАЗ ПАТИНЫ.





MOZART

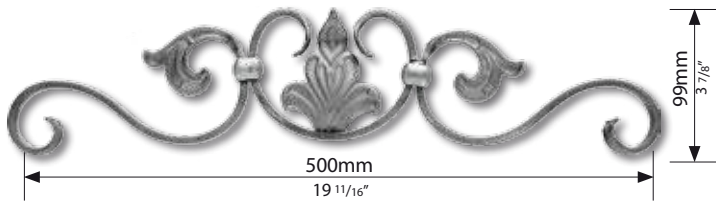

14x6mm
9/16"x1/4" **MOD 52**

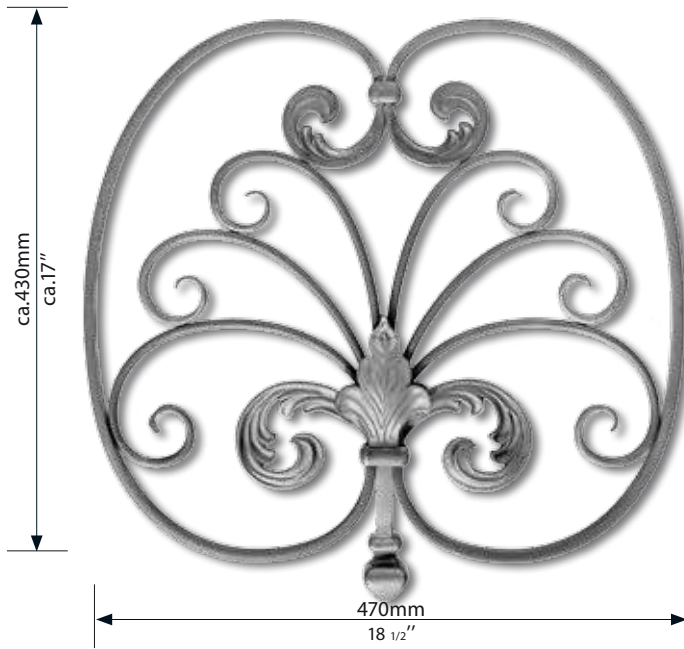

16x8mm
5/8"x5/16" + 8mm
5/16" **MOG 47**

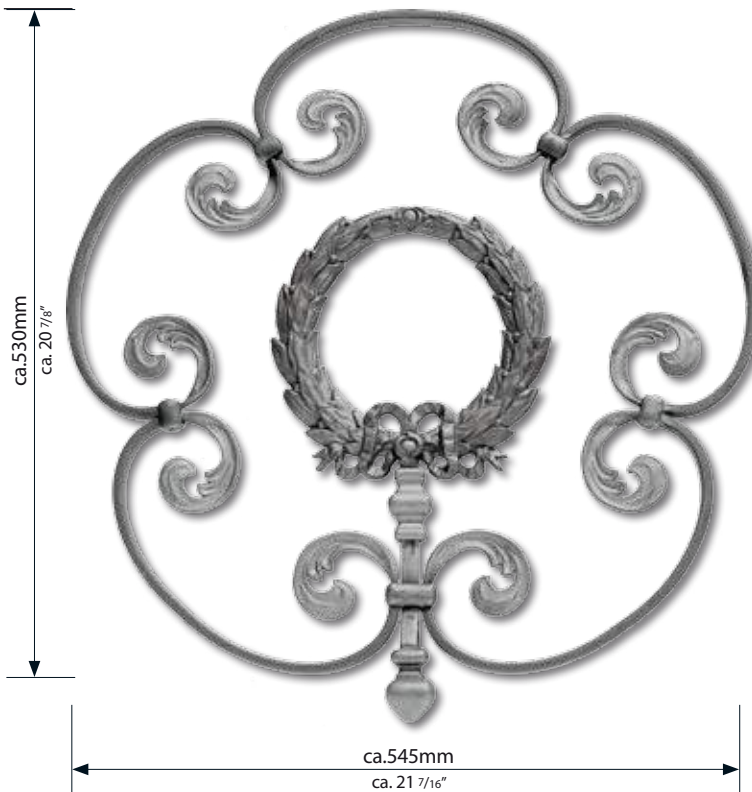

16x8mm
5/8"x5/16" **MOG 50**



16x8mm
5/8"x5/16" **MOB 41**

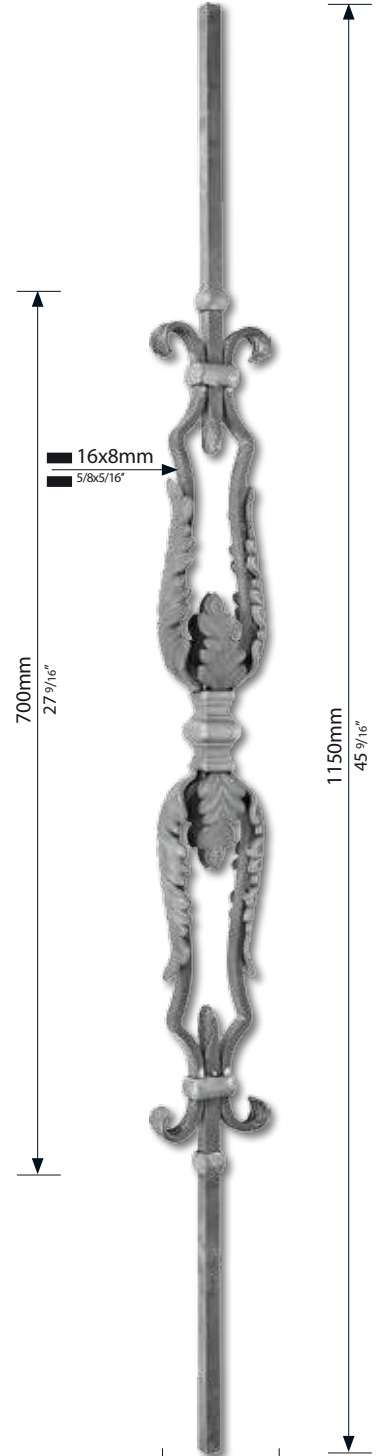

14mm
9/16" **MOB 42**

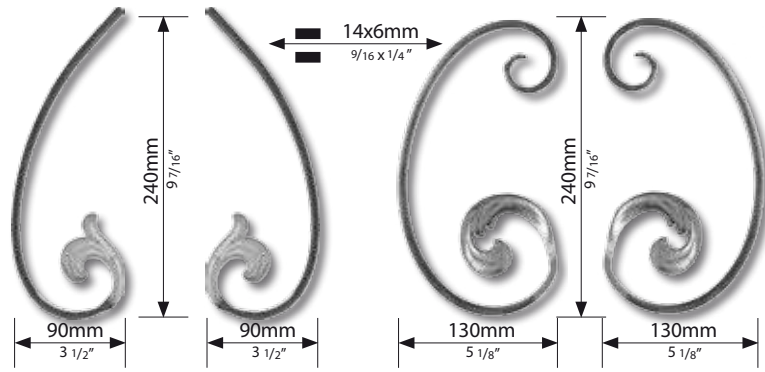

MOJ 25 L

MOJ 25 R

MOC 24 L

MOC 24 R

FRANÇAIS : Hauteur du MOB 45 + MOL 25 = Hauteur du MOG 55

ENGLISH : Height of MOB 45 + MOL 25 = Height of MOG 55

DEUTSCH : Höhe von MOB 45 + MOL 25 = Höhe von MOG 55

NEDERLANDS : Hoogte van MOB 45 + MOL 25 = Hoogte van MOG 55

ESPAÑOL : Altura de MOB 45 + MOL 25 = Altura de MOG 55

RUSSE : Высота элемента MOB 45 + элемент MOL 25 = высота элемента MOG 55



14mm
9/16" **MOB 44**

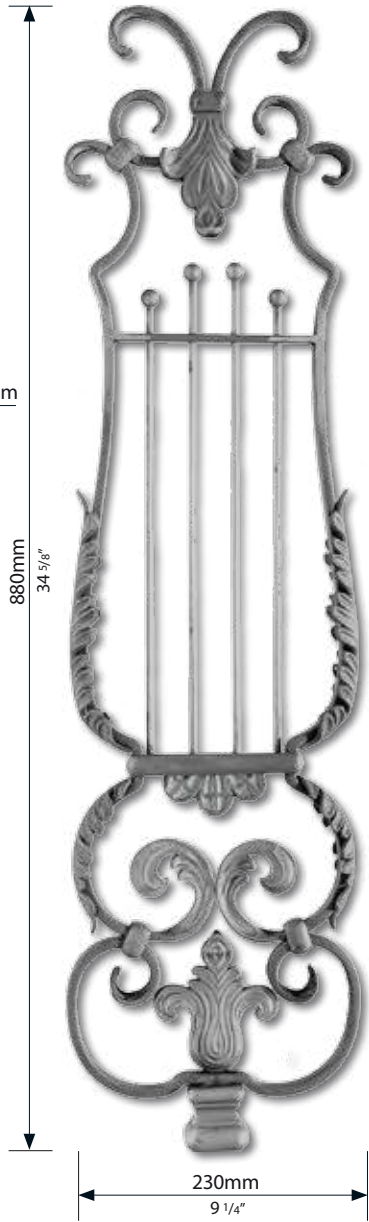

16x8mm
5/8" x 5/16" **MOB 45**

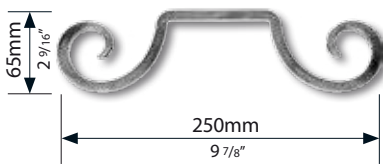

16x8mm
5/8" x 5/16" **MOL 25**

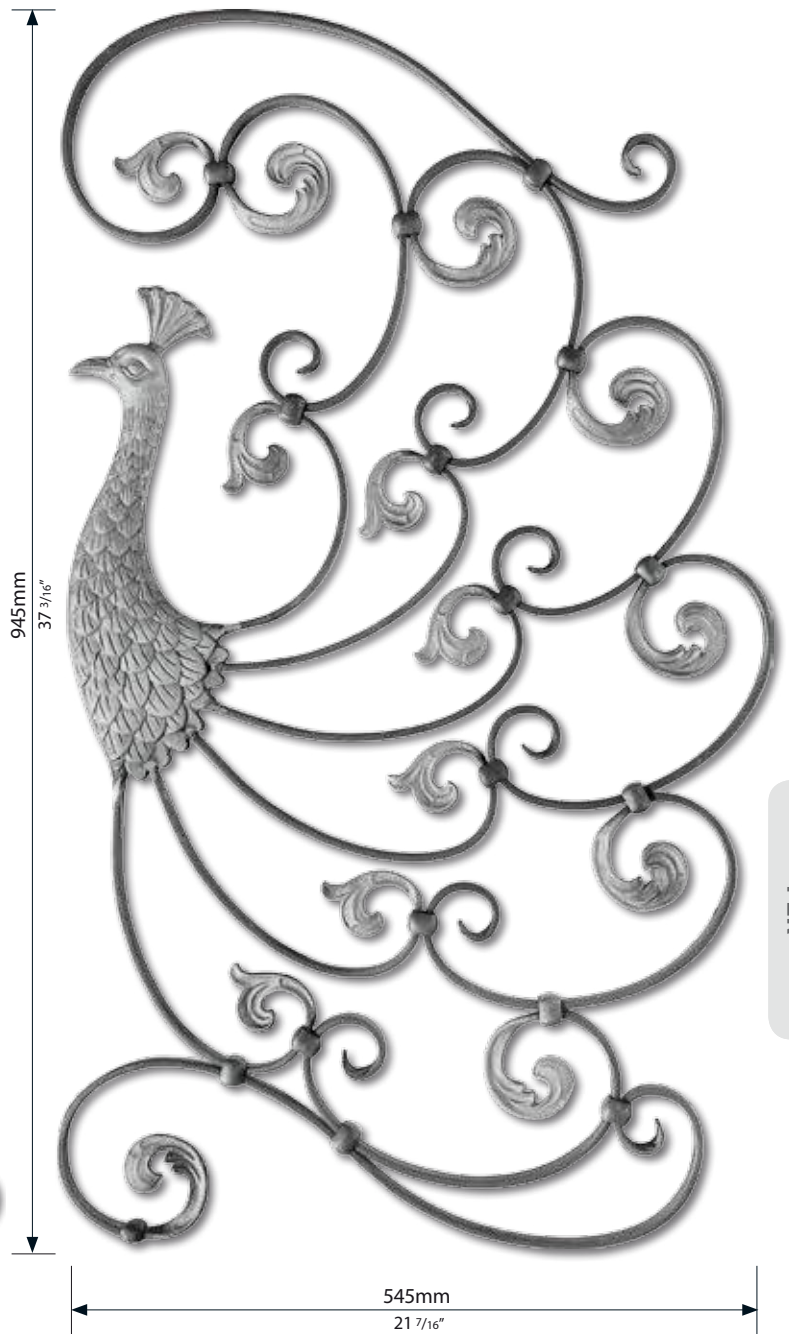

14x6mm
9/16" x 1/4" **MOG 55**

MOZART

FRANÇAIS : Disponible patiné sur demande.

DEUTSCH : lieferbar patiniert auf Anfrage.

ENGLISH : available in a patinated finish upon request.

NEDERLANDS : Leverbaar in gepatineerde uitvoering op aanvraag.

ESPAÑOL : Disponible patinado bajo pedido.

RUSSE : Возможен заказ патины.

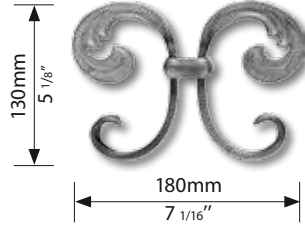
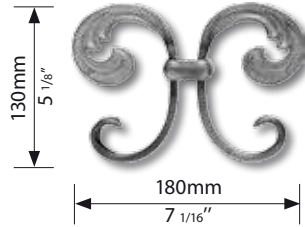
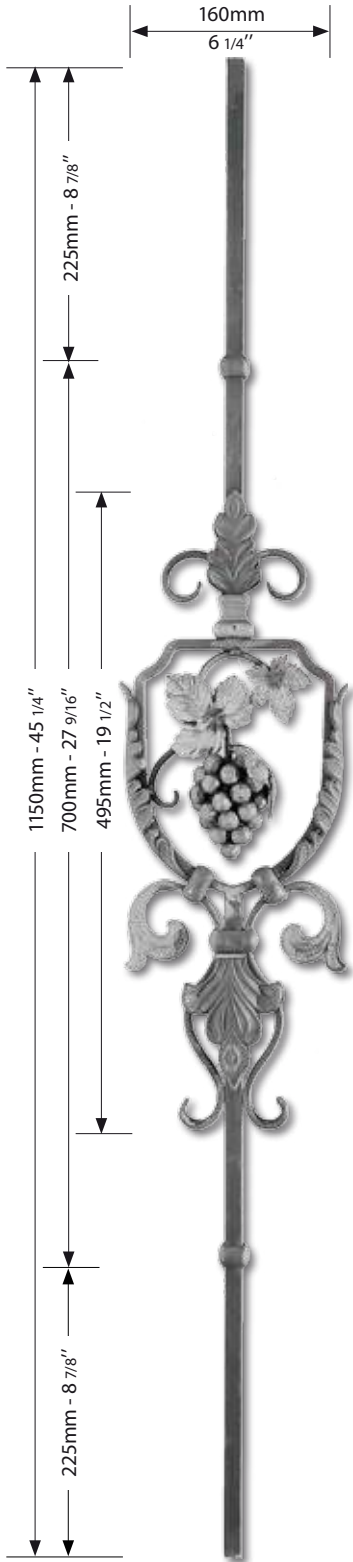

14x6mm
9/16"x1/4" **MOD 82**

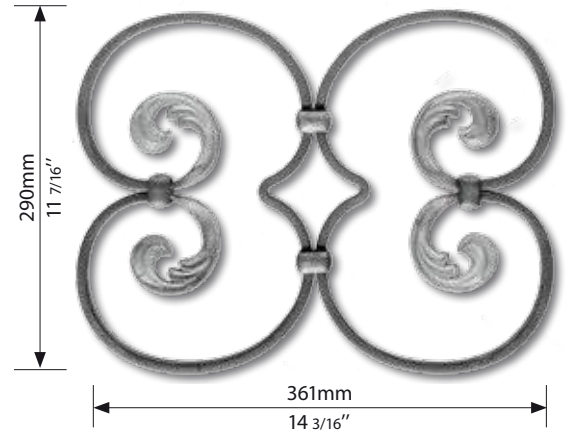
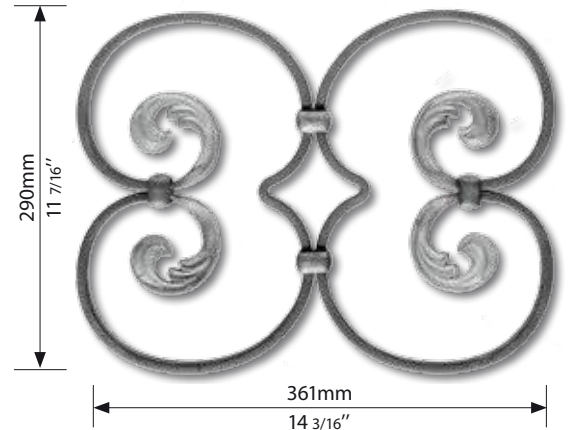

16x8mm
5/8"x5/16" **MOG 35**

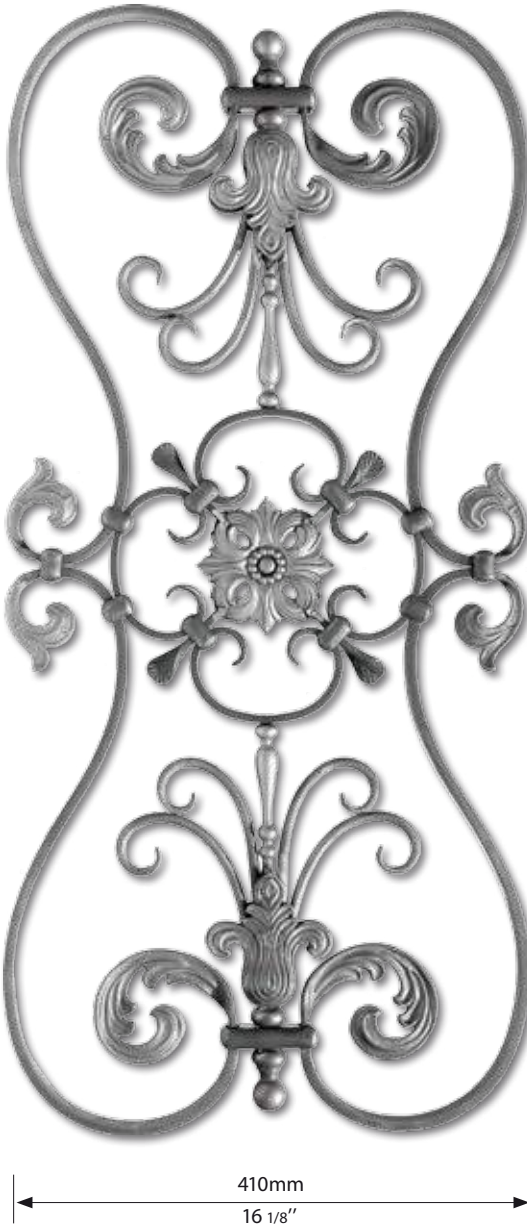

16x8mm
5/8"x5/16" **MOG 40**

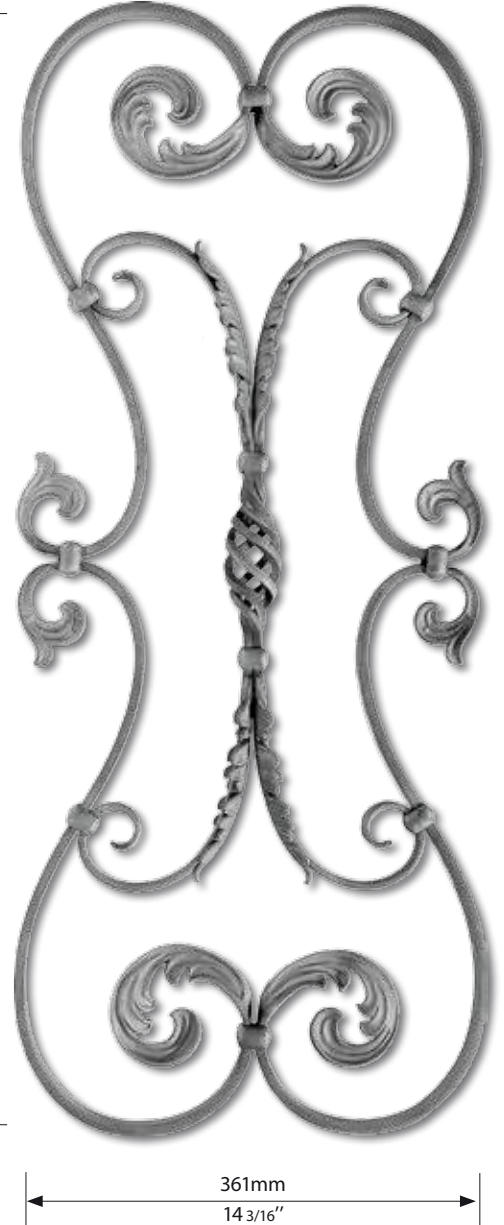

16x8mm
5/8"x5/16" **MOG 36**

14mm
9/16" **MOB 62**

Couronnement de portail en kit
 Zieraufsatz für Tore im Set - Gate top kit
 Set sierornamenten voor dubbele poort
 Coronamiento de portal en kit -
 Венчающий элемент портала в
 комплекте.



ca.1275mm

ca.50 1/4"

270mm
 10 5/8"

■ 16x8mm
 5/8"x5/16" **MOK 128**

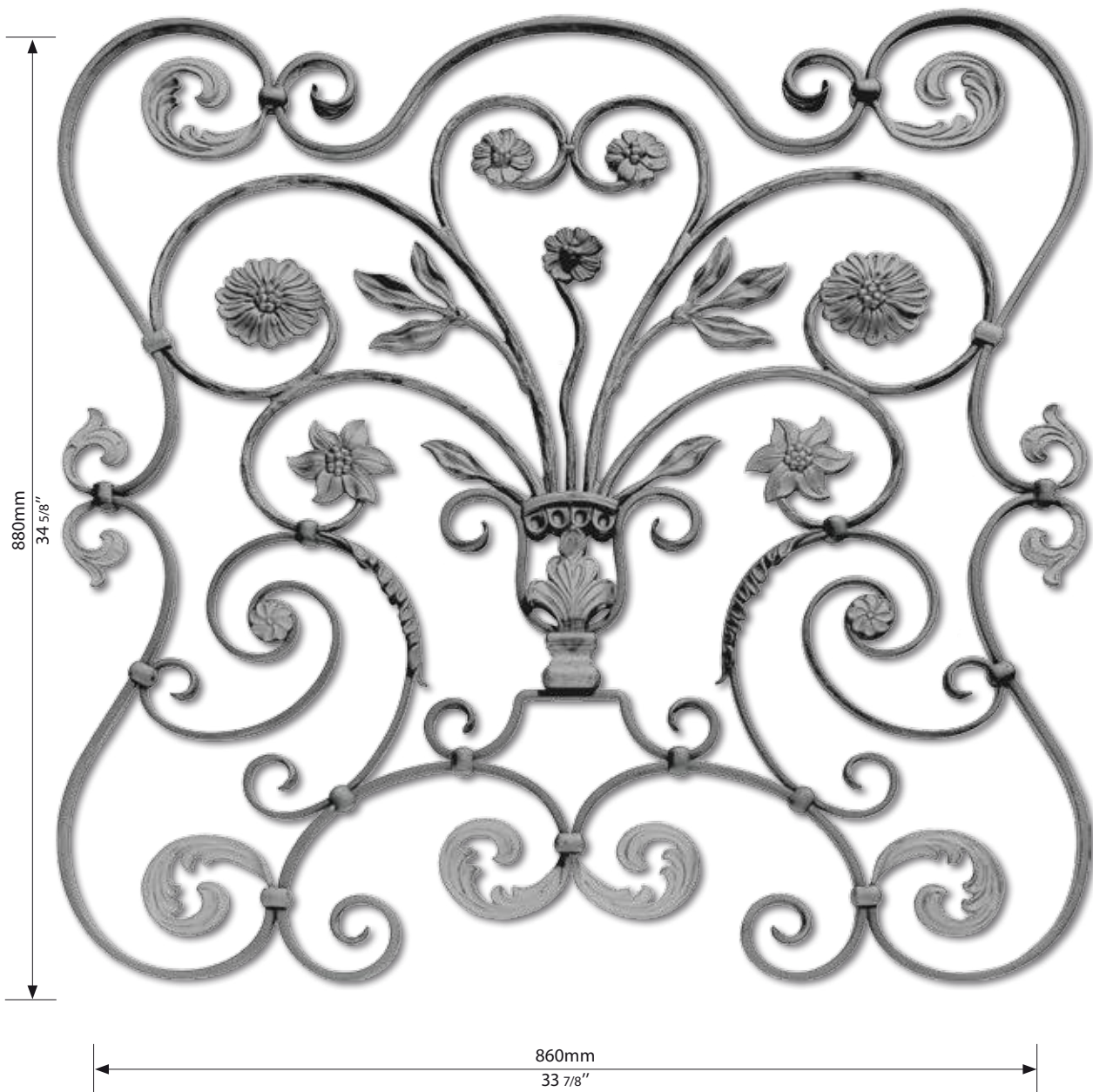

880mm
 34 5/8"

860mm

33 7/8"

■ 16x8mm
 5/8"x5/16" **MOG 86**

CITY

FRANÇAIS : La série CITY allie une ligne moderne à un vrai travail de ferronnerie d'art. Conforme à la norme NF P01-012. Barreaux pour rampes d'escalier (A=770 mm) et pour garde-corps droits (A=820mm).

DEUTSCH : Die Reihe City verbindet eine moderne Linie mit einer wahren Schmiedekunstarbeit. Stäbe für Treppengeländer (A=770 mm) und für gerade Schutzgeländer (A=820 mm).

ENGLISH : The series City combines modern lines with authentic wrought iron work. All styles conform to requirements laid out in NF P01-012. Balusters for stairway handrail (A=770mm) and for level handrail (A=820mm).

NEDERLANDS : De serie City combineert een moderne lijn met authentiek siersmeedwerk. Alle stijlen voldoen aan de regelgeving NF P01-012. Spijlen voor trapleuningen (A=770 mm) en voor rechte leuningen en balustraden (A=820 mm).

ESPAÑOL : La serie City una línea moderna a un verdadero trabajo de cerrajería artística. Conforme a la norma NF P01-012. Balaustres para barandilla de escalera (A=770 mm) y para antepechos rectos (A=820 mm).

RUSSE : Серия "СИТИ" сочетает в себе современные линии и традиционную работу кузнецов. Соответствует стандарту NF P01-012. Балясины для лестничных перил (A=770 мм) и для прямых поручней (A=820 мм).





CITY

Exemple d'utilisation - Anwendungsbeispiel
 Illustration - Voorbeelden voor toepassingen
 Ejemplo de empleo - Пример использования

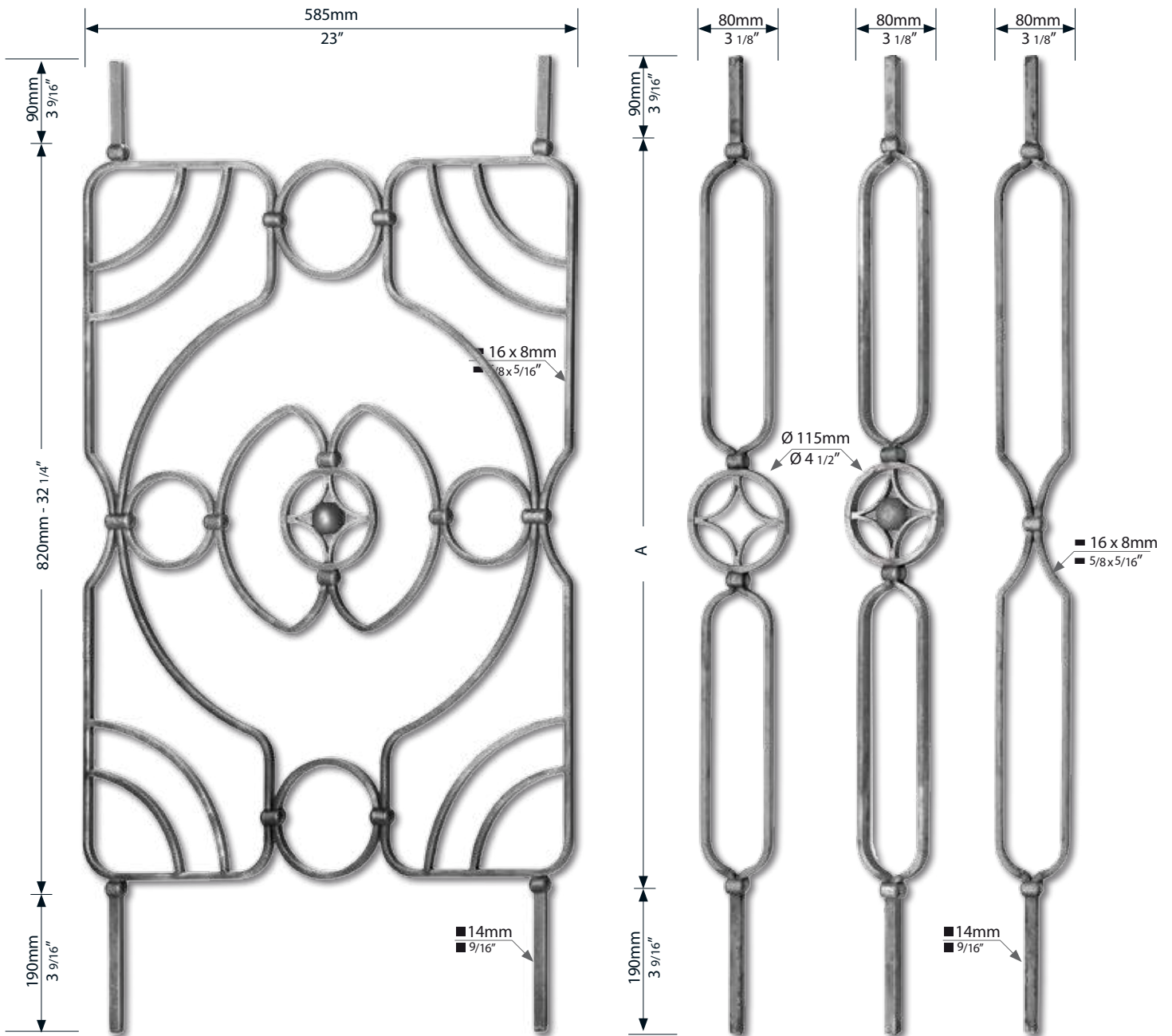

CYEL 125

| | | | |
|-----------------------------|---------|---------|---------|
| A = 770 mm A = 30 15/16" | CYB 110 | CYB 120 | CYB 130 |
| A = 820 mm A = 32 1/4" | CYB 111 | CYB 121 | CYB 131 |

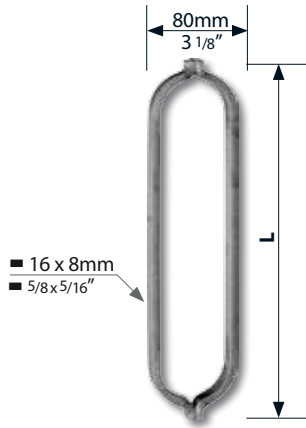

■ 16 x 8mm
■ 5/8 x 5/16"

Cache-scelllements en fer forgé à chaud.
Warm geschmiedete Abdeckrosetten.
Hot forged steel base collars.
Warm gesmede afdekrosetten.
Pletinas y embellecedores de hierro forjado en caliente.
Основания из стали, изготовлены способом горячейковки.

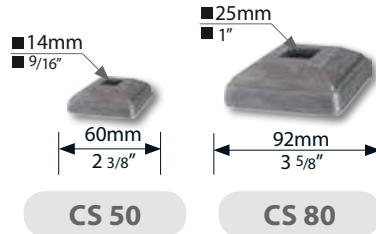

■ 14mm
■ 9/16"

■ 25mm
■ 1"

CS 50

CS 80

L = 315 mm
L = 123 3/8"
L = 340 mm
L = 133 3/8"
CYD 112
CYD 113

Eléments décoratifs en acier moulé. Soudables et galvanisables.
Zierelemente aus Schmiedeguß. Schweißbar und feuerverzinkbar.
Steel castings suitable for welding and galvanizing.
Geprofileerde sierornamenten uit las- en verzinkbaar gietijzer.
Elementos decorativos en acero moldeado. Soldables y galvanizables.

Декоративные элементы отлитые стали. Пригодны для сварки и цинкования.

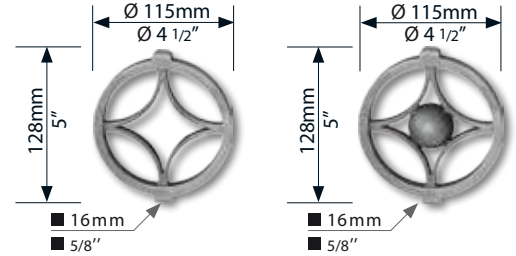

CR 116

CR 115

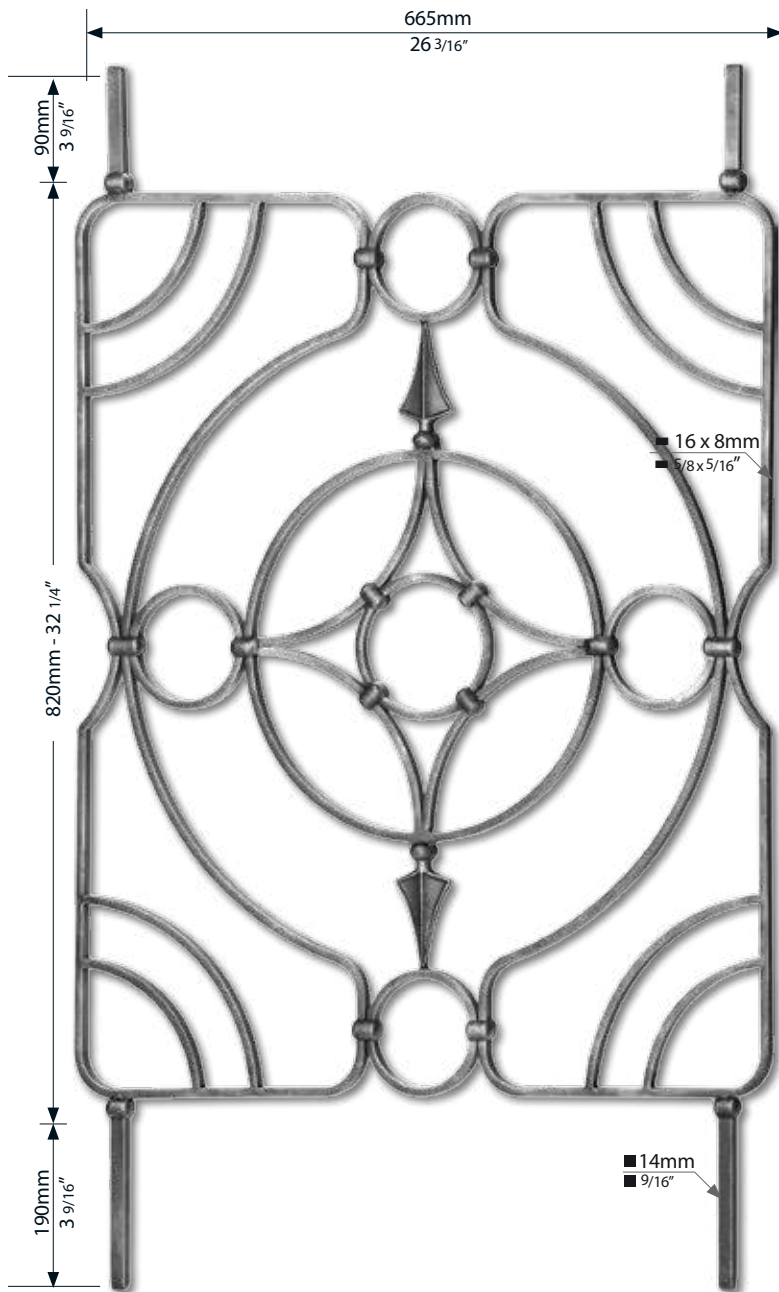

■ 16 x 8mm
■ 5/8 x 5/16"

■ 14mm
■ 9/16"

CYEL 135



Manchons en acier (galvanisables) avec vis de fixation.
Zierhülsen aus Eisen (Feuerverzinkbar) mit Blockierschraube.
Steel collars (suitable for galvanizing) are supplied with a set screw.
Sierhulzen uit staal voorzien (verzinkbaar) van een blokkeerschroef.
Macollas en acero (galvanizable) con tornillo de fijación.
Муфты из стали (пригодны для цинкования) с зажимным винтом.

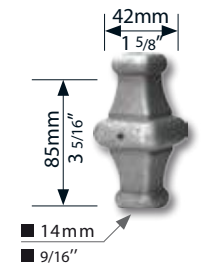

■ 14mm
■ 9/16"

EGK 82

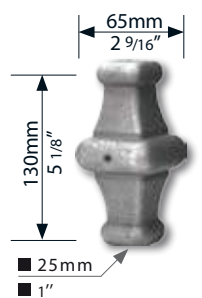

■ 25mm
■ 1"

EGK 125

Exemple d'utilisation - Anwendungsbeispiel
Illustration - Voorbeelden voor toepassingen
Ejemplo de empleo - Пример использования.

QUARTZ

FRANÇAIS : La tendance géométrique se retrouve beaucoup dans l'univers de la mode. Aujourd'hui, elle s'invite dans votre intérieur pour un style pétillant et original. Carrés, ronds, losanges, triangles ou rectangles, la géométrie s'installe sur les murs, le sol, le textile, jusqu'aux rampes d'escaliers. Inspirée de l'art abstrait, la mode des formes géométriques a su tirer parti de leurs peintures. La collection QUARTZ se détache de la réalité pour offrir une autre forme d'expression au-delà des apparences. Elle met l'accent sur des vibrations, des sensations, des émotions

DEUTSCH : Der geometrische Trend ist sehr stark in der Modewelt. Heute lädt sie sich für einen funkelnden und originellen Stil in Ihr Zuhause ein. Quadrate, Kreise, Rauten, Dreiecke oder Rechtecke, die Geometrie setzt sich an den Wänden, dem Boden, dem Textil bis zu den Treppengeländern ab. Inspiriert von der abstrakten Kunst nutzte die Mode der geometrischen Formen ihre Gemälde. Die QUARTZ-Kollektion hebt sich von der Realität ab und bietet eine andere Ausdrucksform, die über den Anschein hinausgeht. Es konzentriert sich auf Vibrationen, Empfindungen, Emotionen

ENGLISH : The geometric trend is very much in the world of fashion. Today, she invites herself into your home for a sparkling and original style. Squares, circles, rhombuses, triangles or rectangles, the geometry settles on the walls, the ground, the textile, until the banisters of stairs. Inspired by abstract art, the fashion of geometric shapes took advantage of their paintings. The QUARTZ collection stands out from reality to offer another form of expression beyond appearances. It focuses on vibrations, sensations, emotions

NEDERLANDS : De geometrische trend is heel erg in de modewereld. Vandaag nodigt ze zichzelf uit in je huis voor een sprankelende en originele stijl. Vierkanten, cirkels, rhombuses, driehoeken of rechthoeken, de geometrie nestelt zich op de muren, de grond, het textiel, tot aan de trapleuningen. Geïnspireerd door abstracte kunst profiteerde de mode van geometrische vormen van hun schilderijen. De QUARTZ-collectie onderscheidt zich van de realiteit en biedt een andere vorm van expressie dan het uiterlijk. Het richt zich op trillingen, sensaties, emoties

ESPAÑOL : La tendencia geométrica está muy presente en el mundo de la moda. Hoy, ella se invita a su hogar para un estilo brillante y original. Cuadrados, círculos, rombos, triángulos o rectángulos, la geometría se instala en las paredes, el suelo, el textil, hasta las barandillas de las escaleras. Inspirada en el arte abstracto, la moda de las formas geométricas aprovechó sus pinturas. La colección QUARTZ se destaca de la realidad para ofrecer otra forma de expresión más allá de las apariencias. Se enfoca en vibraciones, sensaciones, emociones.

RUSSE : Ортогональная геометрия дает ощущение глубины и легкости этим стальным балясиной. Сдержанные и экстравагантные, в то же время их линии позволяют создавать художественные балюстрады, смешивая современный дух и кубистическое вдохновение.



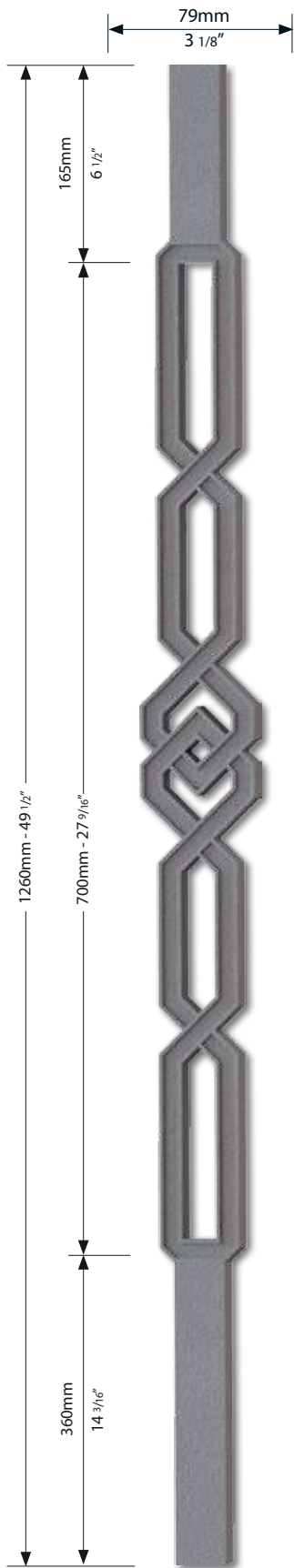

■ 35 mm
1 3/8" **QZP 135**

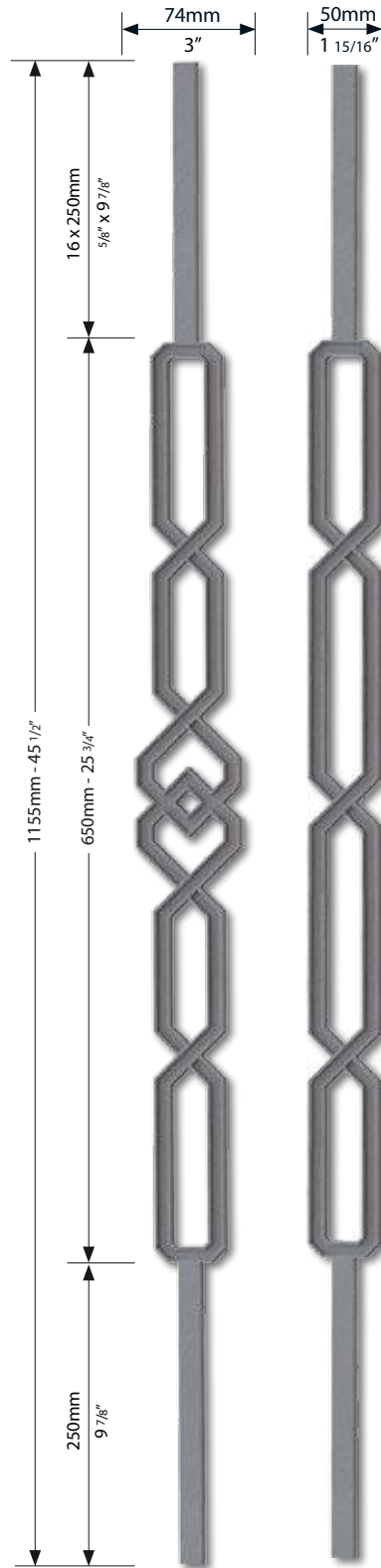

■ 16 mm
5/8" **QZB 116** **QZB 106**

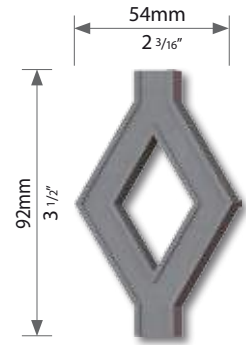

■ 16 mm
5/8" **QZK16**

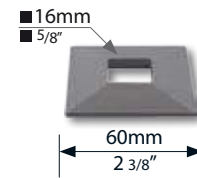

CSKF16

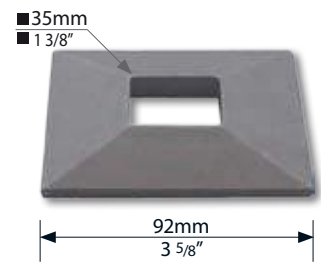

CSKF35

TRADITION

FRANÇAIS : Ces balustres répondent à une des exigences d'un beau travail de ferronnerie : une harmonie parfaite des lignes et des formes.

DEUTSCH : Diese Zierstäbe entsprechen mit ihrer perfekten Harmonie und Linienführung der Forderung einer schönen Kunstschmiedearbeit.

ENGLISH : These balusters meet one of the demands for a fine and artistic forging : a perfect harmony of the lines and forms.

NEDERLANDS : Deze sierspijlen zijn door hun perfecte harmonie een vormgeving voor het hedendaagse siersmeedwerk.

ESPAÑOL : Estos balaustres responden a las exigencias de un hermoso trabajo de cerrajería : una armonía perfecta de líneas y formas.

RUSSE : Эти стойки удовлетворяют спрос покупателей на изделия изящной художественнойковки: полная гармония линий и форм.





TRADITION

FRANÇAIS : Ces balustres répondent à une des exigences d'un beau travail de ferronnerie : une harmonie parfaite des lignes et des formes.

DEUTSCH : Diese Zierstäbe entsprechen mit ihrer perfekten Harmonie und Linienführung der Forderung einer schönen Kunstschmiedearbeit.

ENGLISH : These balusters meet one of the demands for a fine and artistic forging : a perfect harmony of the lines and forms.

NEDERLANDS : Deze sierspijlen zijn door hun perfecte harmonie een vormgeving voor het hedendaagse siersmeedwerk.

ESPAÑOL : Estos balaustres responden a las exigencias de un hermoso trabajo de cerrajería : una armonía perfecta de líneas y formas.

RUSSE : Эти стойки удовлетворяют спрос покупателей на изделия изящной художественнойковки: полная гармония линий и форм.

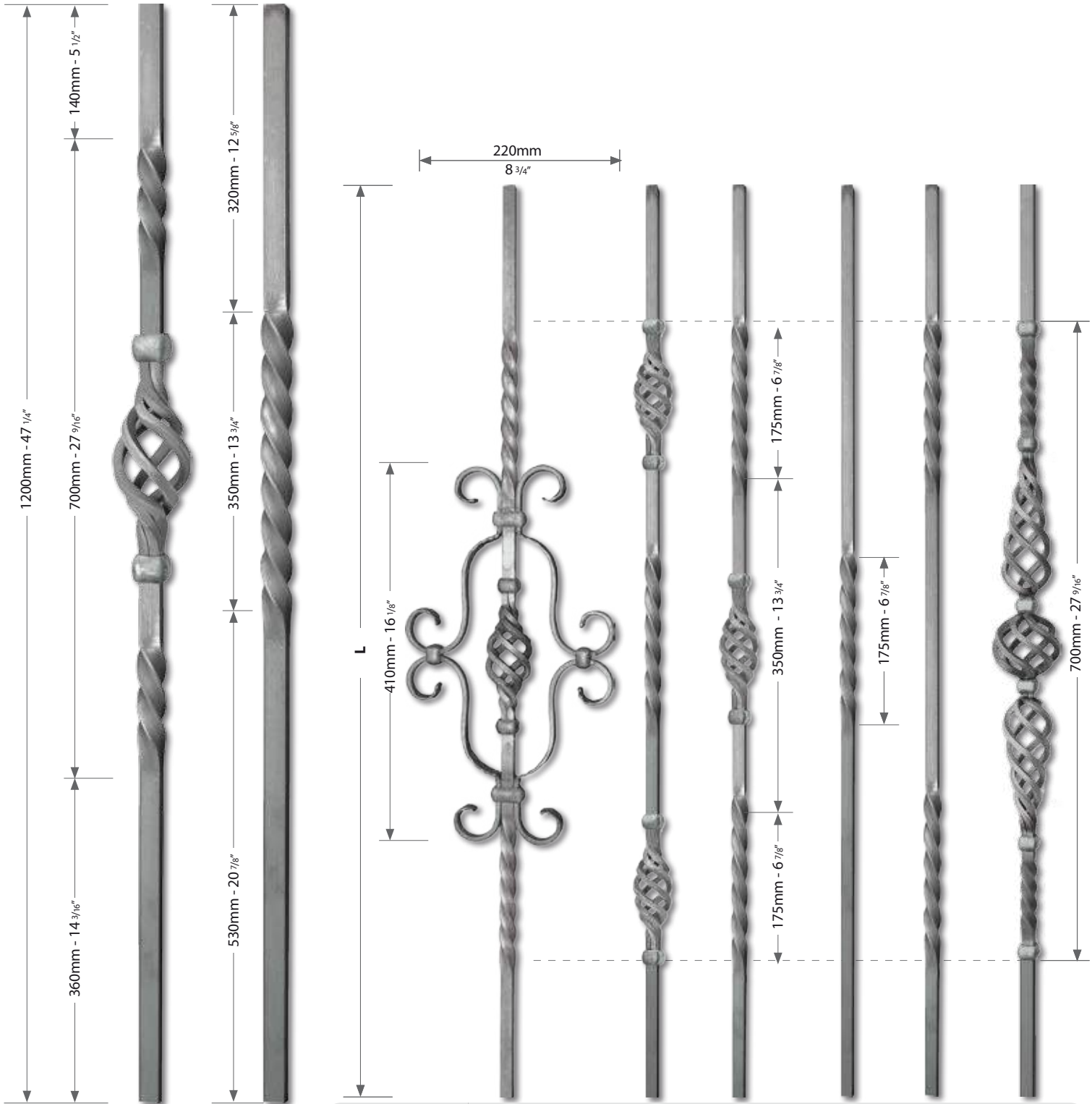

| | | |
|------------------|--------|-------|
| 20 mm 3/4" | PS 121 | P 131 |
| 25 mm 1" | PS 122 | P 132 |
| 30 mm 1 3/16" | PS 126 | P 136 |

| | | | | | | | |
|----------------|----------------------------|--------|--------|--------|--------|--------|--------|
| 12 mm 1/2" | L : 1000 mm L : 39 3/8" | B 1701 | B 3201 | B 3001 | B 9111 | B 9201 | - |
| 14 mm 9/16" | L : 1000 mm L : 39 3/8" | B 1702 | B 3202 | B 3002 | B 9112 | B 9202 | - |
| 14 mm 9/16" | L : 1150 mm L : 45 1/2" | B 1704 | B 3204 | B 3004 | B 9114 | B 9204 | B 3104 |
| 16 mm 5/8" | L : 1150 mm L : 45 1/2" | - | B 3206 | B 3006 | B 9116 | B 9206 | - |

TRADITION

FRANÇAIS : Très différents d'un fer carré torsadé à froid, ces balustres sont d'abord forgés à chaud.

Les torsades sont ainsi particulièrement mises en valeur par le relief de la forge.

DEUTSCH : Im Gegensatz zu einem kaltgedrehten Vierkanteisen werden diese Zierstäbe warm ausgeschmiedet und gedreht. Die Drehungen sind dadurch besonders effektiv.

ENGLISH : Very different from an ordinary twisted bar, these balusters have first been hot forged. Due to the relief of the forge the twists are particularly effective and beautiful.

NEDERLANDS : Geheel verschillend, van vierkant ijzer, worden deze sierspijken warm uitgesmeed en getordeerd. Deze tordering krijgt hierdoor een bijzonder effect.

ESPAÑOL : De forma muy distinta a los hierros cuadrangulares torcidos en frío, estos balaustres están previamente forjados en caliente.

RUSSE : Большое разнообразие форм, различные виды обработки – кованные и скрученные из стального квадрата.

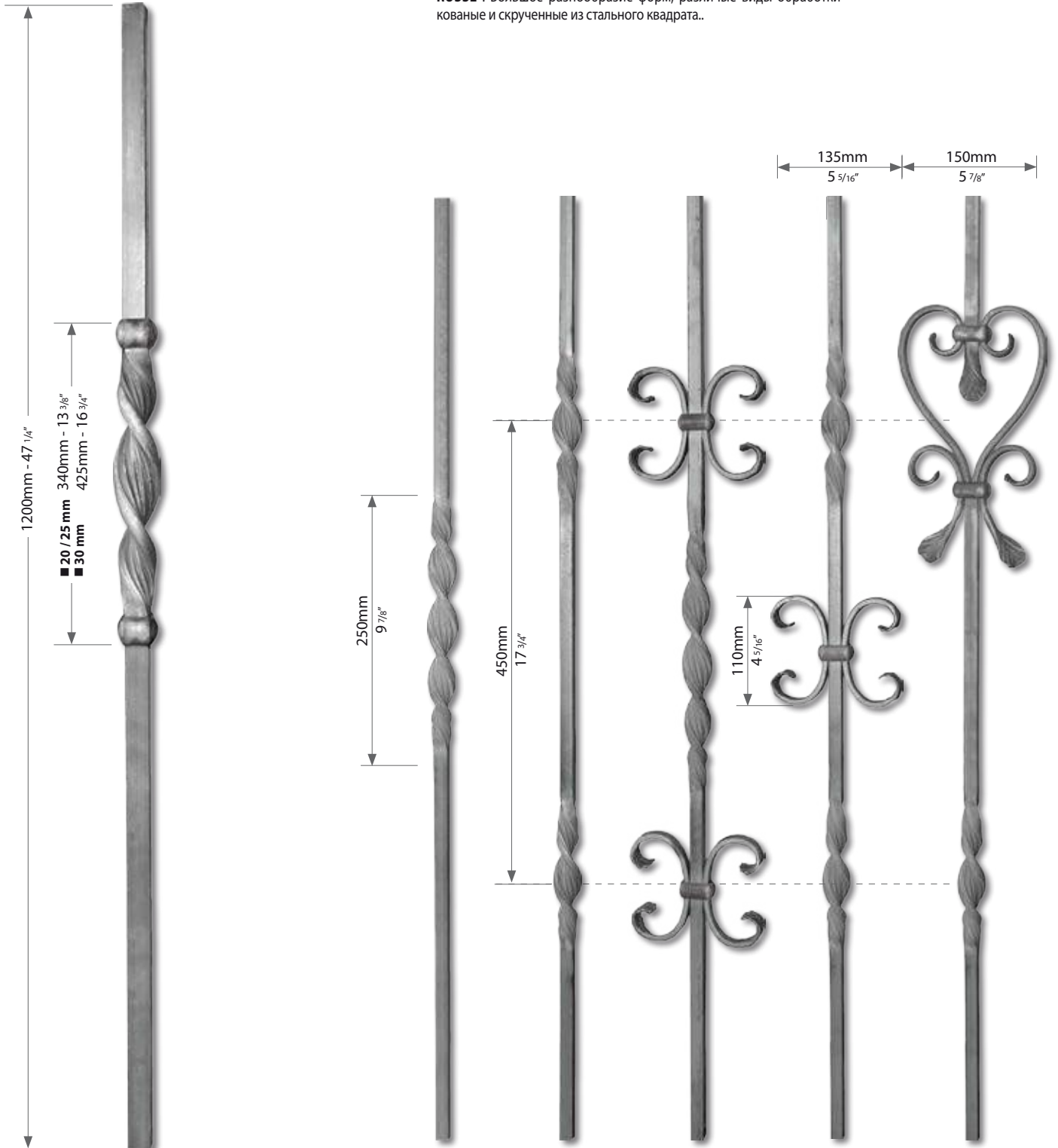

| | |
|--------------------|-------|
| ■ 20 mm 3/4" | P 121 |
| ■ 25 mm 1" | P 122 |
| ■ 30 mm 1 3/16" | P 126 |

| | | | | | |
|-----------------------------------|--------|--------|--------|--------|--------|
| ■ 12 x 1000 mm 1/2" x 39 3/8" | B 0101 | B 0201 | B 0801 | B 0701 | B 0901 |
| ■ 14 x 1000 mm 9/16" x 39 3/8" | B 0102 | B 0202 | B 0802 | B 0702 | B 0902 |
| ■ 14 x 1150 mm 9/16" x 45 1/2" | B 0104 | B 0204 | B 0804 | B 0704 | B 0904 |
| ■ 16 x 1150 mm 5/8" x 45 1/2" | B 0106 | B 0206 | B 0806 | B 0706 | - |

TRADITION

Exemples d'utilisation
 Anwendungsbeispiele
 For illustration purposes only
 Voorbeelden voor toepassingen
 Ejemplos de empleo
 Пример использования

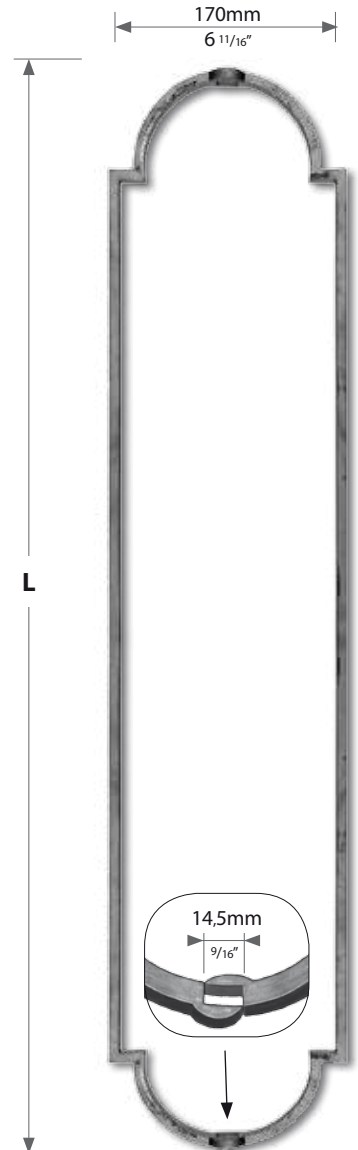
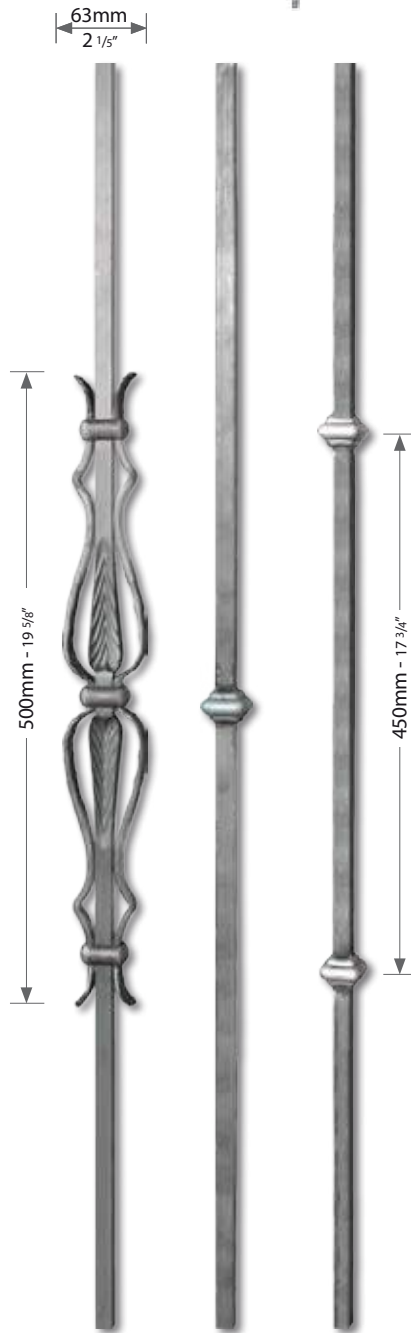
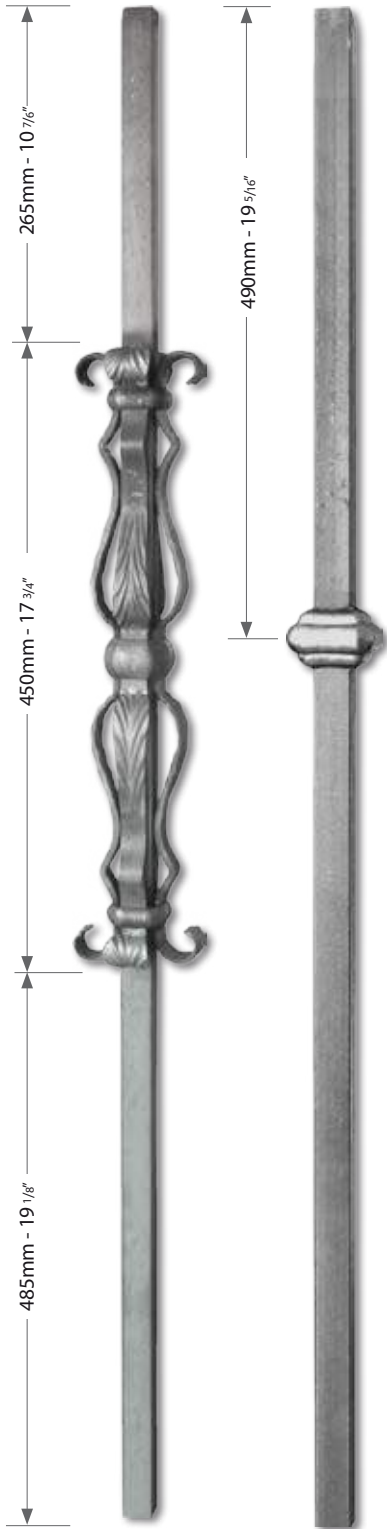
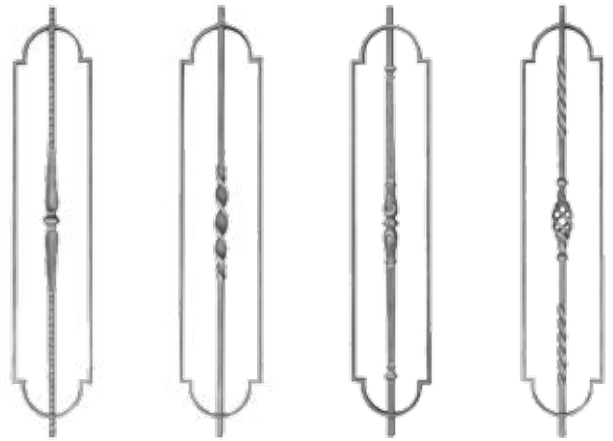

| | | |
|-----------------|-------|-------|
| ■ 20 mm 3/4" | P 151 | - |
| ■ 25 mm 1" | P 152 | P 100 |

| | | | |
|-----------------------------------|--------|--------|--------|
| ■ 12 x 1000 mm 1/2" x 39 3/8" | B 1551 | B 1011 | B 1911 |
| ■ 14 x 1000 mm 9/16" x 39 3/8" | B 1552 | B 1012 | B 1912 |
| ■ 14 x 1150 mm 9/16" x 45 1/2" | B 1554 | B 1014 | B 1914 |
| ■ 16 x 1150 mm 5/8" x 45 1/2" | - | B 1016 | B 1916 |

| | | |
|----------------------------|--------------------------|-------|
| ■ 16 x 8 mm 5/8 x 5/16" | L: 770 mm L: 30 5/16" | B 100 |
| ■ 16 x 8 mm 5/8 x 5/16" | L: 820 mm L: 32 1/4" | B 101 |

TRADITION

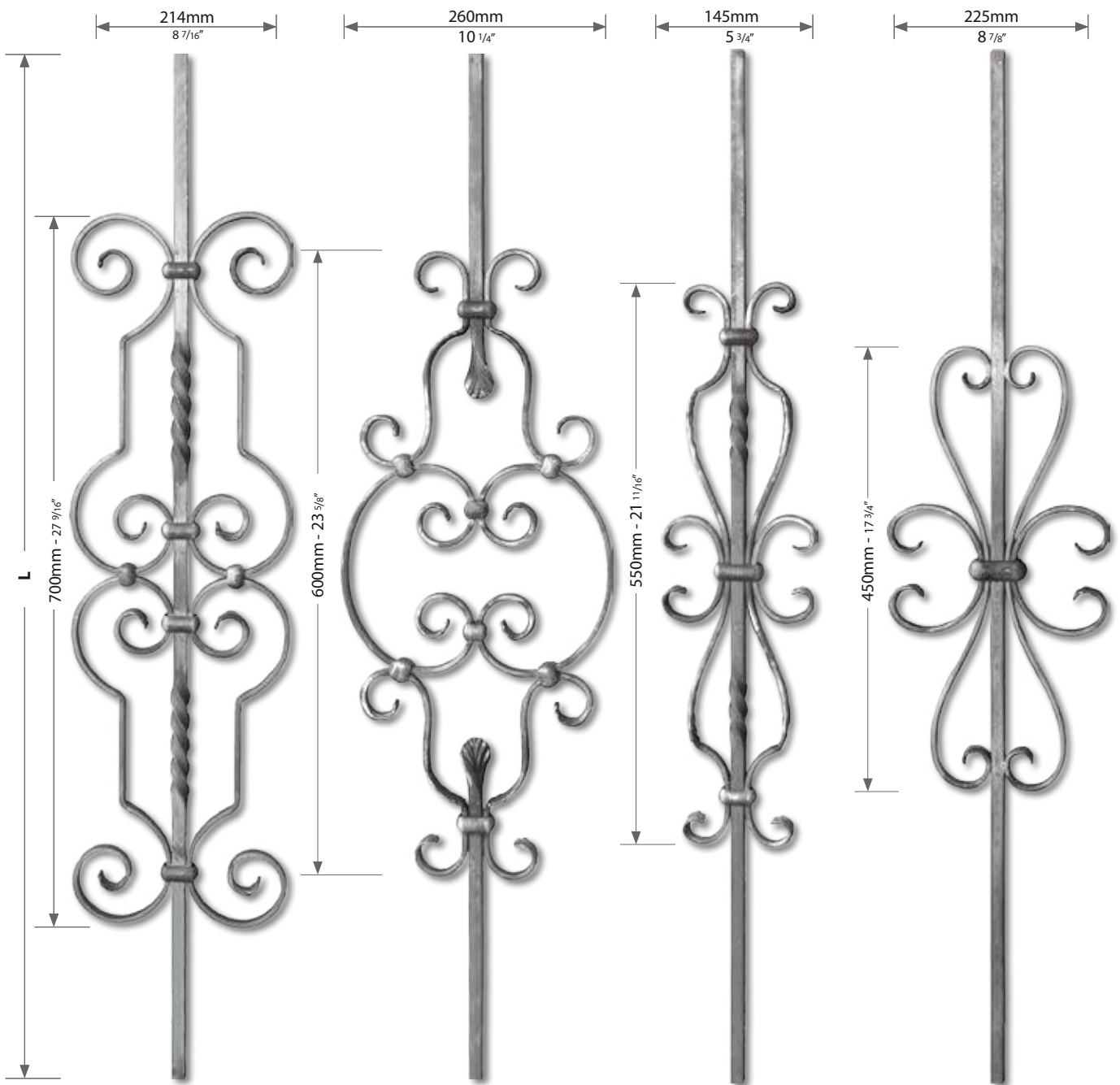

| | | | | | |
|------------------|---------------|----------------------------|---------------|---------------|---------------|
| ■ 12 mm 1/2" | B 5001 | L : 1000 mm L : 39 3/8" | B 3601 | B 1801 | B 0401 |
| ■ 14 mm 9/16" | B 5002 | L : 1000 mm L : 39 3/8" | B 3602 | B 1802 | B 0402 |
| ■ 14 mm 9/16" | B 5004 | L : 1150 mm L : 45 1/2" | B 3604 | B 1804 | B 0404 |

FER

TRADITION

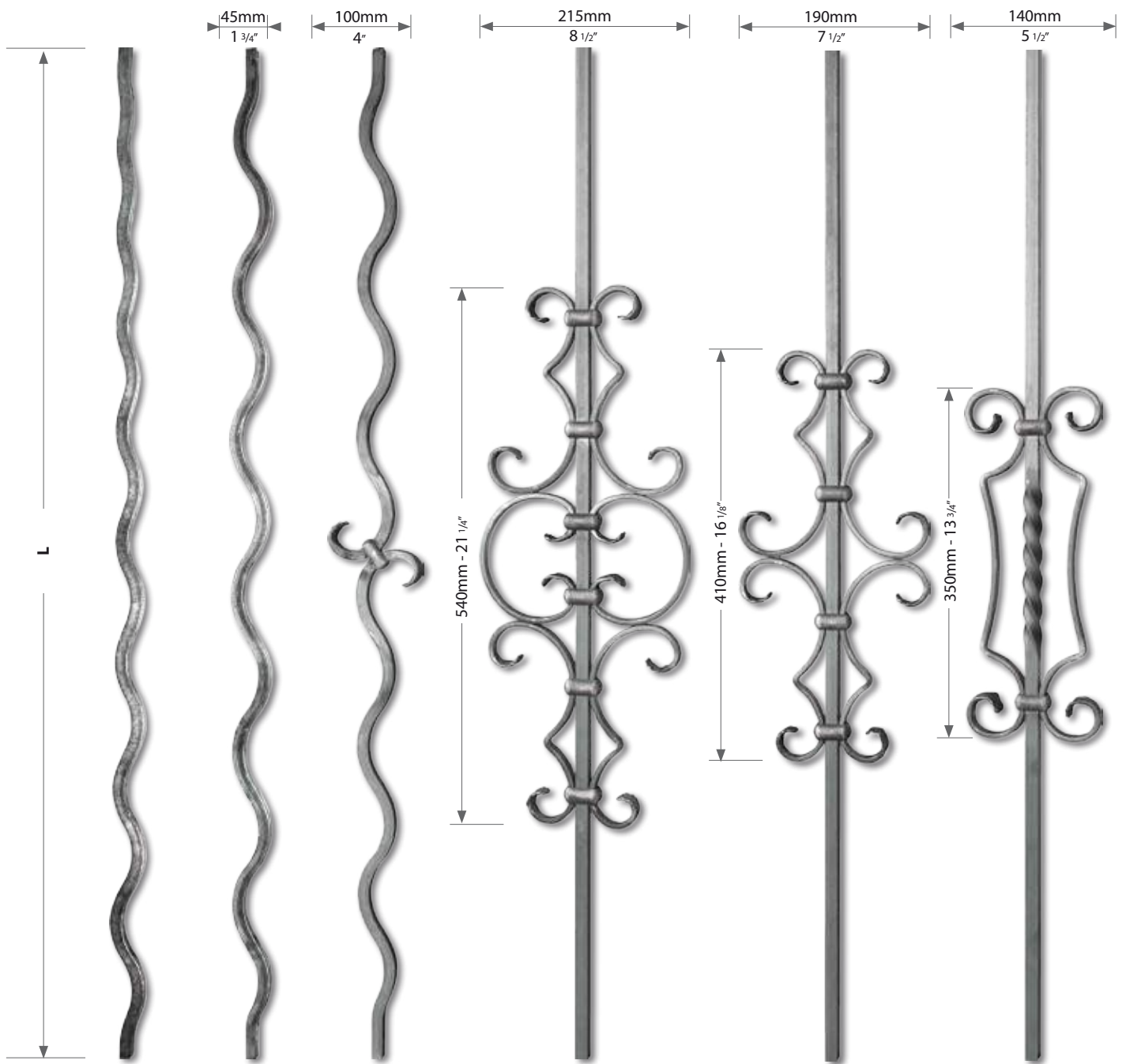

| | | | | |
|------------------|--------------------------|---------------|---------------|---------------|
| ■ 12 mm 1/2" | L: 950 mm L: 37 3/8" | - | B 4701 | B 4801 |
| ■ 14 mm 9/16" | L: 950 mm L: 37 3/8" | - | B 4702 | B 4802 |
| ■ 14 mm 9/16" | L: 1150 mm L: 45 1/2" | B 4604 | B 4704 | B 4804 |

| | | | | |
|------------------|---------------|--------------------------|---------------|---------------|
| ■ 12 mm 1/2" | B 3711 | L: 1000 mm L: 39 3/8" | B 2711 | B 1601 |
| ■ 14 mm 9/16" | B 3712 | L: 1000 mm L: 39 3/8" | B 2712 | B 1602 |
| ■ 14 mm 9/16" | B 3714 | L: 1150 mm L: 45 1/2" | B 2714 | B 1604 |

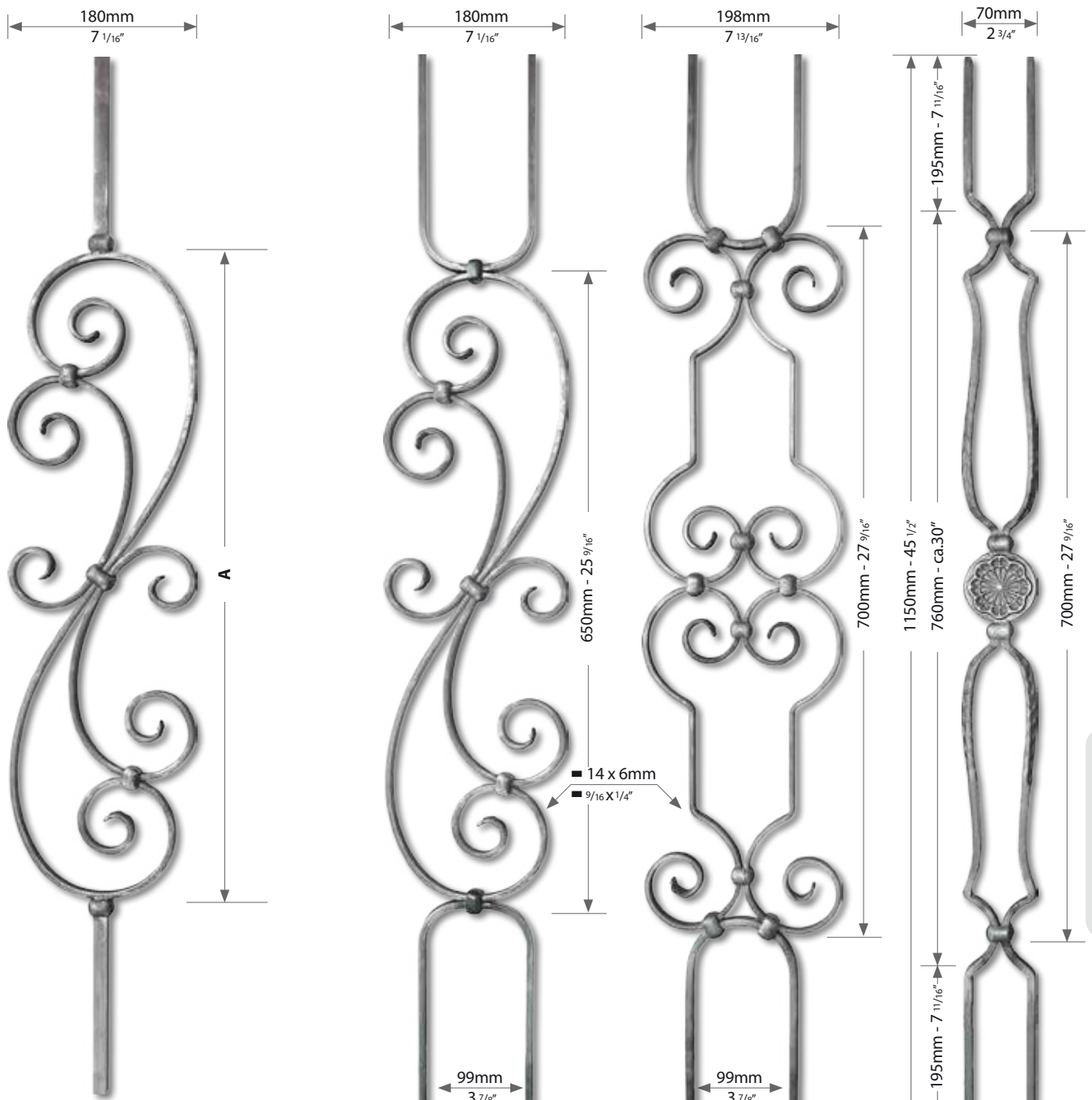

| | | | | |
|------------------|----------------------------|---------------|----------------------------|------------------------|
| ■ 12 mm 1/2" | L : 1000 mm L : 39 3/8" | B 4001 | A : 650 mm A : 25 9/16" | ■ 14x6mm 9/16"x1/4" |
| ■ 14 mm 9/16" | L : 1000 mm L : 39 3/8" | B 4002 | A : 650 mm A : 25 9/16" | ■ 14x6mm 9/16"x1/4" |
| ■ 14 mm 9/16" | L : 1150 mm L : 45 1/2" | B 4004 | A : 650 mm A : 25 9/16" | ■ 14x6mm 9/16"x1/4" |
| ■ 16 mm 5/8" | L : 1150 mm L : 45 1/2" | B 4006 | A : 700 mm A : 27 9/16" | ■ 16x8mm 5/8"x5/16" |

B 4104

B 5104

B 1404

FER

TRADITION

FRANÇAIS : Ces balustres répondent à une des exigences d'un beau travail de ferronnerie : une harmonie parfaite des lignes et des formes.

DEUTSCH : Diese Zierstäbe entsprechen mit ihrer perfekten Harmonie und Linienführung der Forderung einer schönen Kunstschmiedearbeit.

ENGLISH : These balusters meet one of the demands for a fine and artistic forging : a perfect harmony of the lines and forms.

NEDERLANDS : Deze sierspijlen zijn door hun perfecte harmonie een vormgeving voor het hedendaagse siersmeedwerk.

ESPAÑOL : Estos balustres responden a las exigencias de un hermoso trabajo de cerrajería : una armonía perfecta de líneas y formas.

RUSSE : Эти стойки удовлетворяют спрос покупателей на изделия изящной художественнойковки: полная гармония линий и форм.

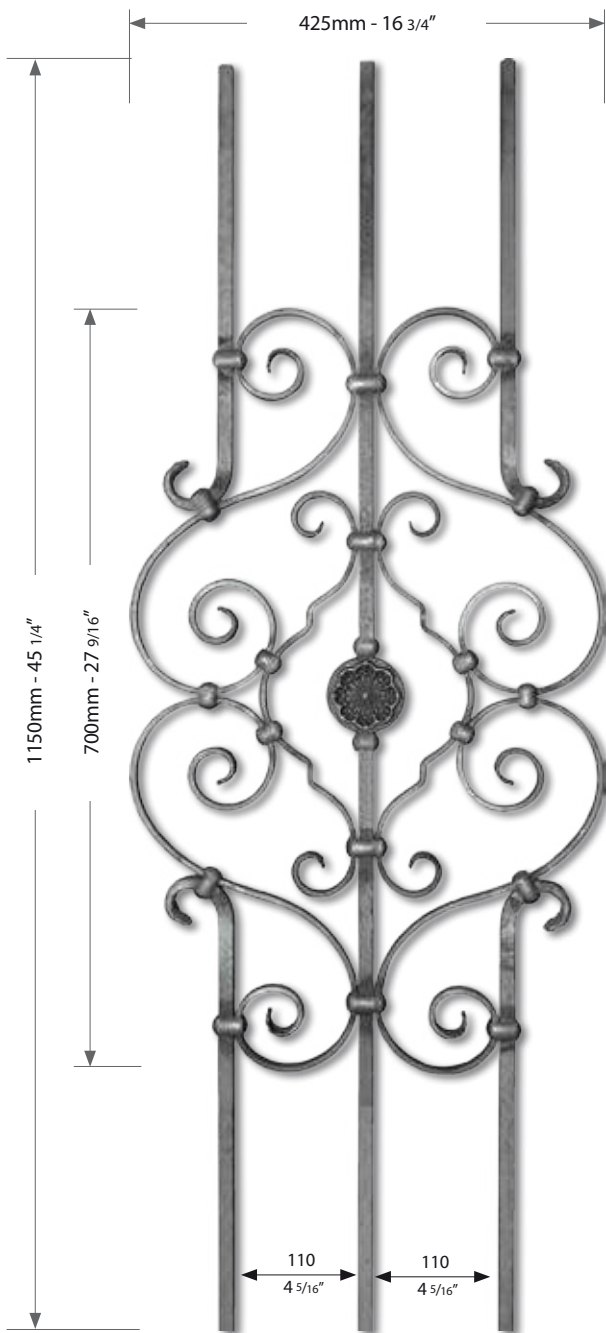

| | | |
|------------------|----------------------------|---------------|
| ■ 12 mm 1/2" | ■ 12 x 6 mm 1/2 x 1/4" | EL 601 |
| ■ 14 mm 9/16" | ■ 14 x 6 mm 9/16 x 1/4" | EL 604 |

| | | |
|------------------|----------------------------|---------------|
| ■ 14 mm 9/16" | ■ 14 x 6 mm 9/16 x 1/4" | EL 706 |
|------------------|----------------------------|---------------|

TRADITION

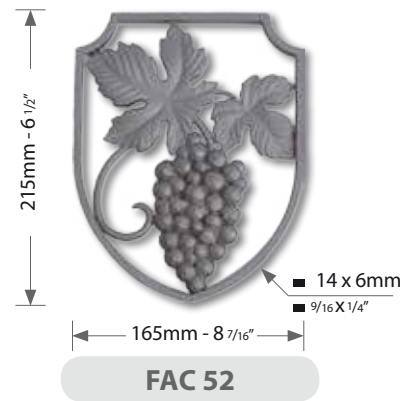
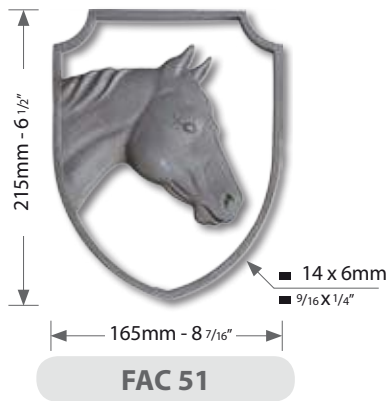
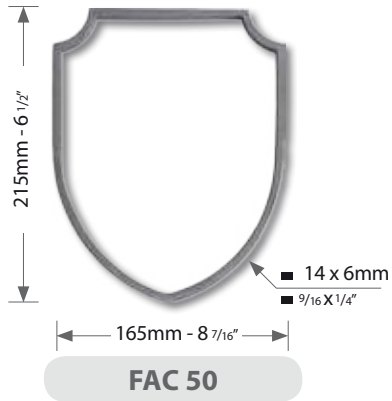

TRADITION

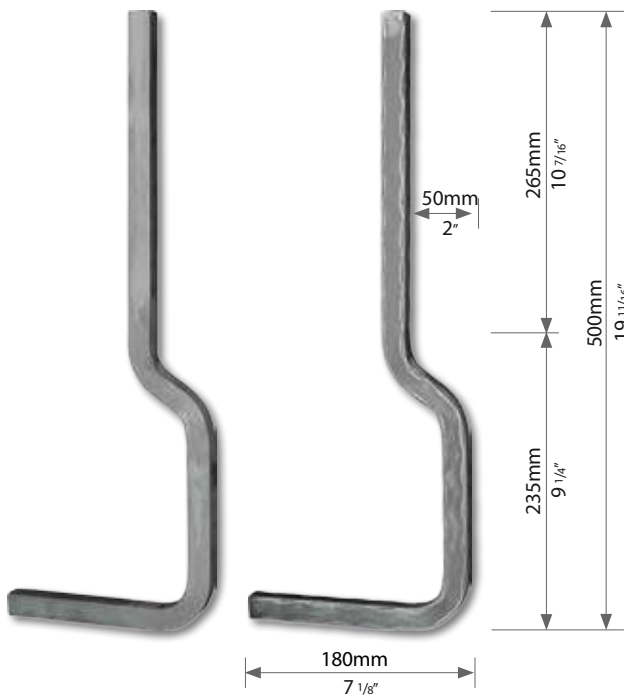

FRANÇAIS : Support de lisse inférieure. Pour accessoires, voir page 196.

DEUTSCH : Untergurtstütze. Zubehör siehe Seite 196.

ENGLISH : Bottom-rail bracket. For fittings see page 196.

NEDERLANDS : Trappleuningsteun. Voor toebehoren zie pagina 196.

ESPAÑOL : Soporte para barra de apoyo inferior. Para accesorios, ver página 196.

RUSSE : Нижний кронштейн для перил. Выбрать подходящие аксессуары можно на странице 196.

■ 20mm 3/4" **SP 50** **SPM 50**



■ 14mm 9/16" **G 542** **G 552** **G 562**



■ 14mm 9/16" **G 772** **G 782**
■ 16mm 5/8" **G 776** **G 786**

FRANÇAIS : Exemples d'utilisation avec éléments préassemblés : Voir pages 184-185.

DEUTSCH : Anwendungsbeispiele mit vorgebundeten Zierlementen: Siehe Seiten 184-185.

ENGLISH : Illustration with prefabricated ornaments. See pages 184-185.

NEDERLANDS : Voorbeelden voor toepassingen van voorgeassembleerde sierelementen. Zie pagina's 184-185.

ESPAÑOL : Ejemplos de empleo con elementos preensamblados. Ver páginas 184-185.

RUSSE : Образцы использования в комплекте с декоративными элементами: смотрите страницы 184-185.

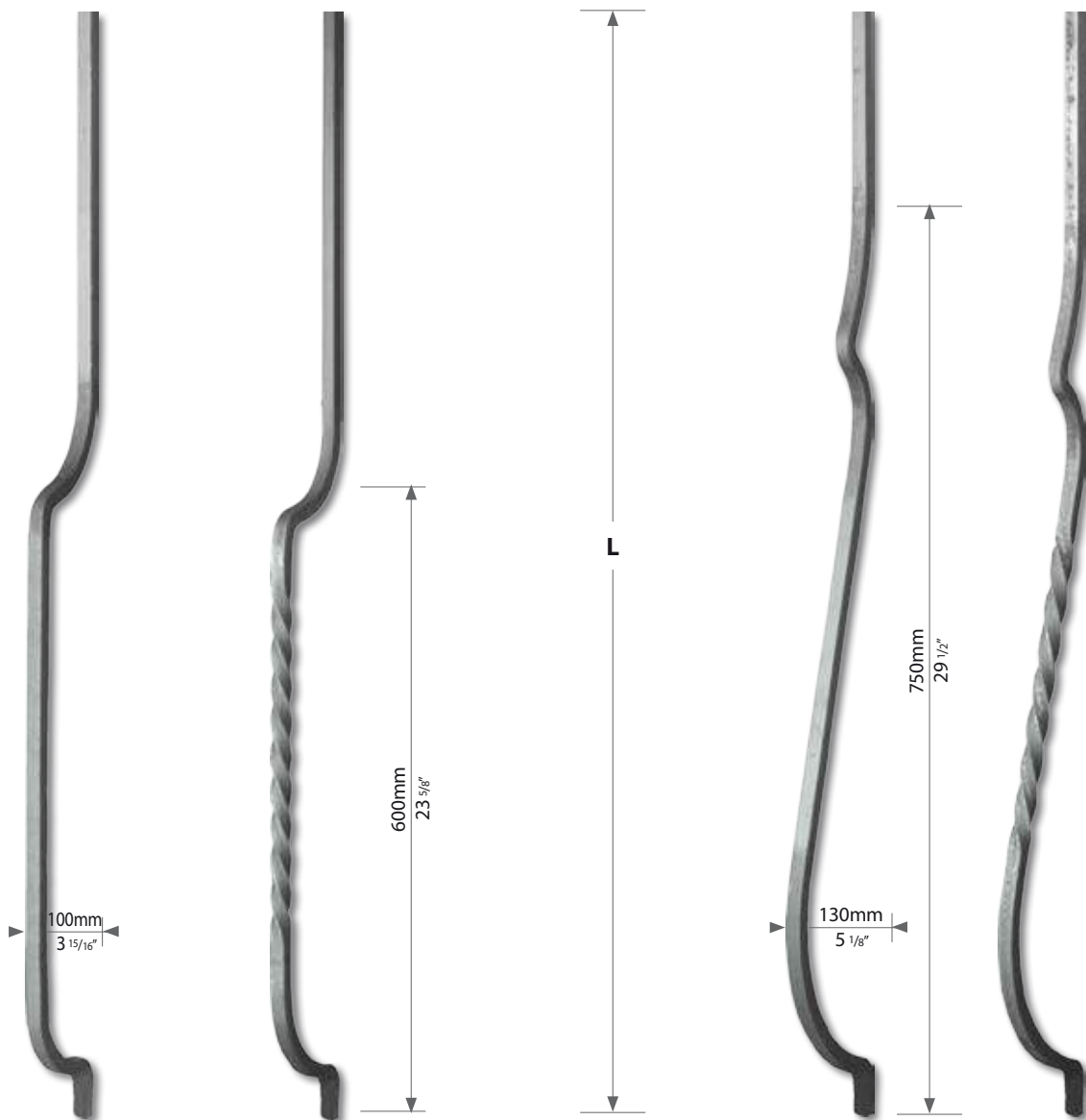
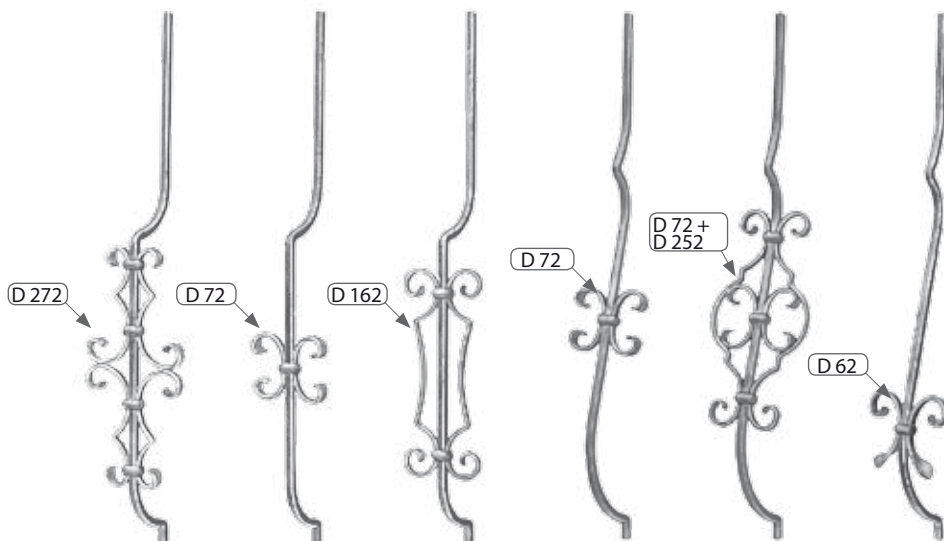

| | | | |
|---------|-------------|----------------|----------------|
| ■ 14 mm | L: 900 mm | G 102 M | G 112 M |
| ■ 9/16" | L: 35 7/16" | | |
| ■ 14 mm | L: 1400 mm | G 102 L | G 112 L |
| ■ 9/16" | L: 55" | | |

| | | | |
|---------|-------------|----------------|----------------|
| ■ 14 mm | L: 900 mm | G 202 M | G 222 M |
| ■ 9/16" | L: 35 7/16" | | |
| ■ 14 mm | L: 1400 mm | G 202 L | G 222 L |
| ■ 9/16" | L: 55" | | |
| ■ 16 mm | L: 900 mm | G 206 M | G 226 M |
| ■ 5/8" | L: 35 7/16" | | |
| ■ 16 mm | L: 1400 mm | G 206 L | G 226 L |
| ■ 5/8" | L: 55" | | |

RUSTIQUE

FRANÇAIS : Cette collection séduit par ses airs d'antan et impose avec style son esprit. Inspirés d'hier et tendance d'aujourd'hui, le style de ces barreaux conjugue authenticité et élégance.

DEUTSCH : Diese Kollektion bezaubert mit ihrer alten Melodie und führt mit Stil ihre RUSTIKALE Seele. Der von den Trends von gestern und heute inspirierte Stil dieser Geländer kombiniert Echtheit und Eleganz

ENGLISH : This collection captivates by its old tunes and imposes with style its spirit. Inspired by yesterday and today's trend, the style of these balusters combines authenticity and elegance.

NEDERLANDS : Deze collectie fascineert door zijn oude deuntjes en legt met stijl zijn geest op. Geïnspireerd door de trend van gisteren en vandaag, combineert de stijl van deze balusters authenticiteit en elegantie.

ESPAÑOL : Esta colección cautiva por sus viejas melodías e impone con estilo su espíritu. Inspirado en la tendencia de ayer y de hoy, el estilo de estos balaustres combina autenticidad y elegancia.

RUSSE : Эта коллекция очаровывает своими старыми мелодиями и навязывает стиль. Вдохновленный вчерашним и сегодняшним трендом, стиль этих балясин сочетает в себе подлинность и элегантность.



RUSTIQUE

FRANÇAIS : Les barreaux galbés ci-dessous sont fabriqués en 2 longueurs différentes : **M = 900 mm ; L = 1400 mm.**

DEUTSCH : Diese Korbstäbe sind in 2 verschiedenen Längen lieferbar : **M = 900 mm ; L = 1400 mm.**

ENGLISH : The balusters below are available in 2 different lengths : **M = 900 mm ; L = 1400 mm.**

NEDERLANDS : Deze buikspijlen zijn in 2 lengten leverbaar : **M = 900 mm ; L = 1400 mm.**

ESPAÑOL : Los barrotes, representados abajo, están disponibles en 2 longitudes : **M = 900 mm ; L = 1400 mm.**

RUSSE : Представленные ниже стойки могут иметь две различные длины : **M = 900 mm ; L = 1400 mm.**

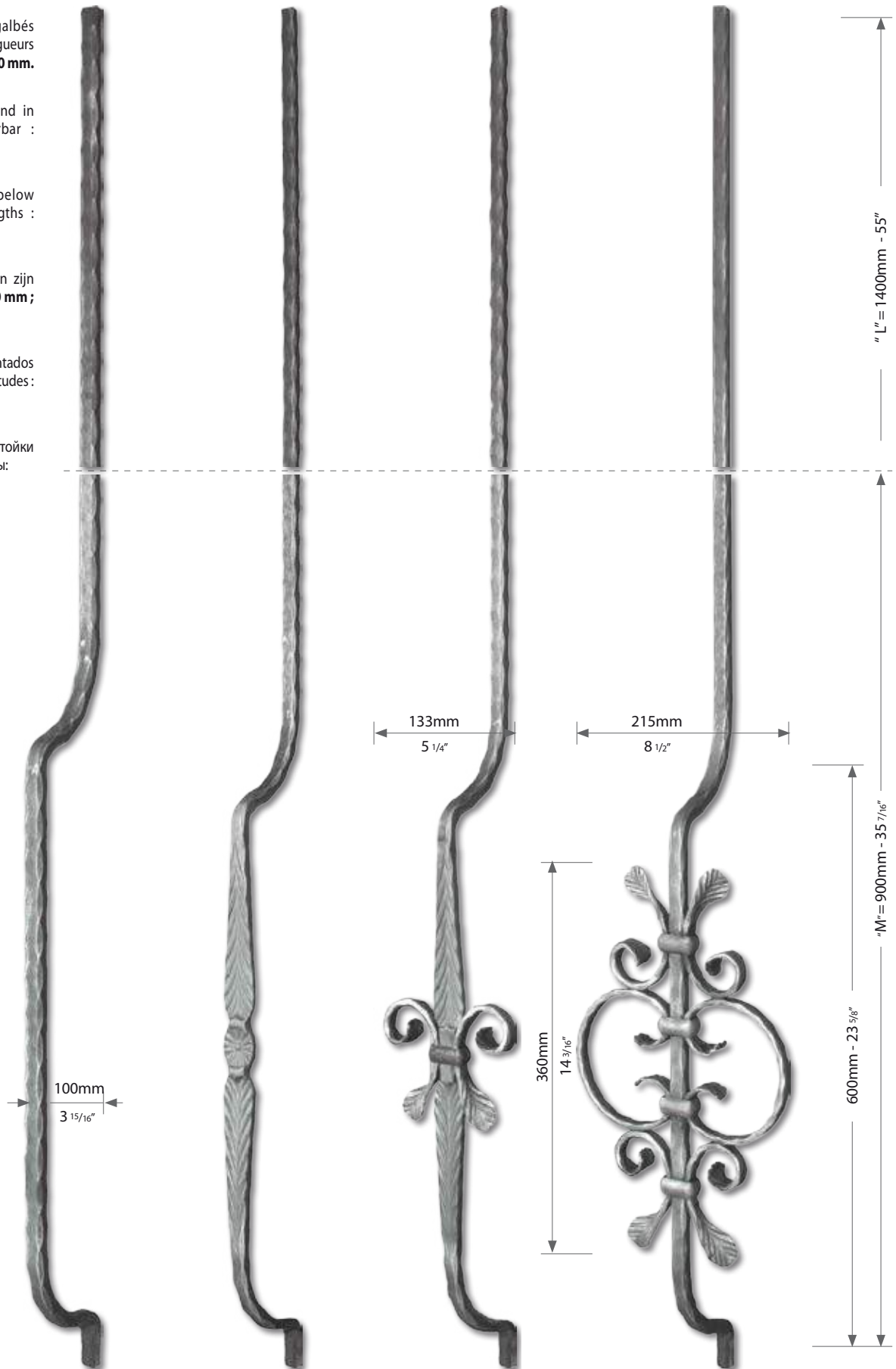

| | | | | | |
|------------------|----------------------------|----------------|----------------|----------------|----------------|
| ■ 14 mm 9/16" | L : 900 mm L : 35 7/16" | G 702 M | G 712 M | G 742 M | G 762 M |
| ■ 14 mm 9/16" | L : 1400 mm L : 55" | G 702 L | G 712 L | G 742 L | G 762 L |

FER

RUSTIQUE

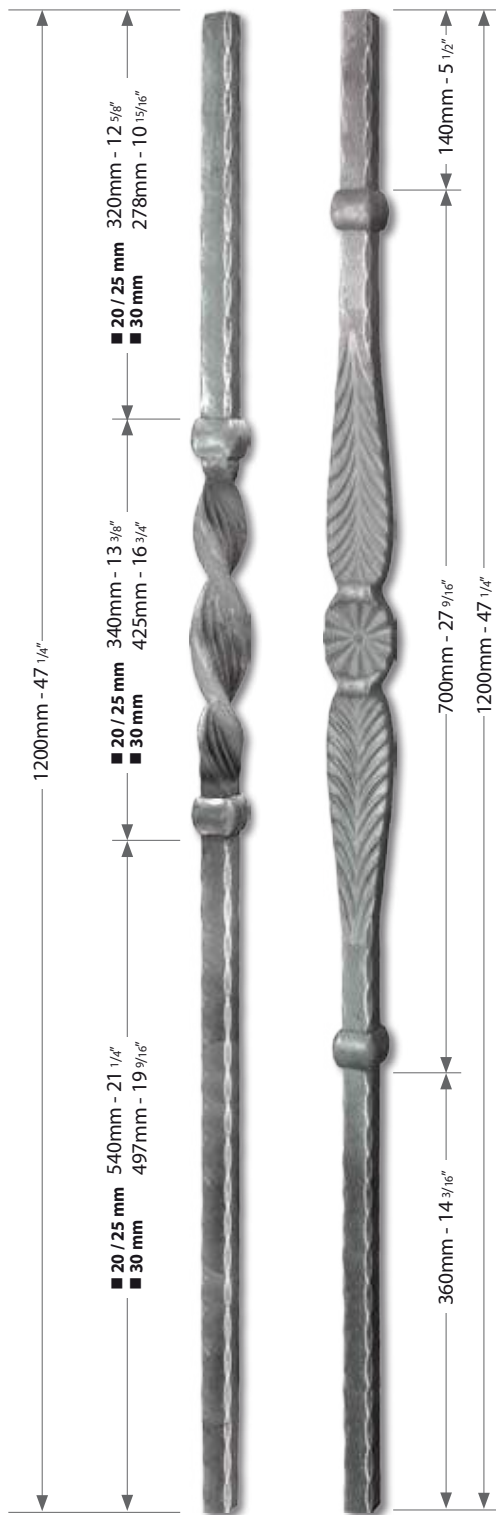

| | | |
|--------------------|--------|--------|
| ■ 20 mm 3/4" | PR 811 | PR 711 |
| ■ 25 mm 1" | PR 812 | PR 712 |
| ■ 30 mm 1 3/16" | PR 816 | PR 716 |

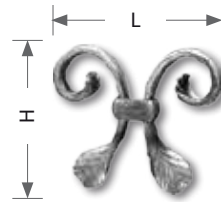

| | | |
|------------------------|--------------|---|
| ■ 12x6mm 1/2"x1/4" | DM 61 | H : 115mm - 4 1/2" L : 134mm - 5 1/4" |
| ■ 14x6mm 9/16"x1/4" | DM 62 | H : 115mm - 4 1/2" L : 134mm - 5 1/4" |
| ■ 16x8mm 5/8"x5/16" | DM 64 | H : 125mm - 4 15/16" L : 160mm - 6 5/16" |

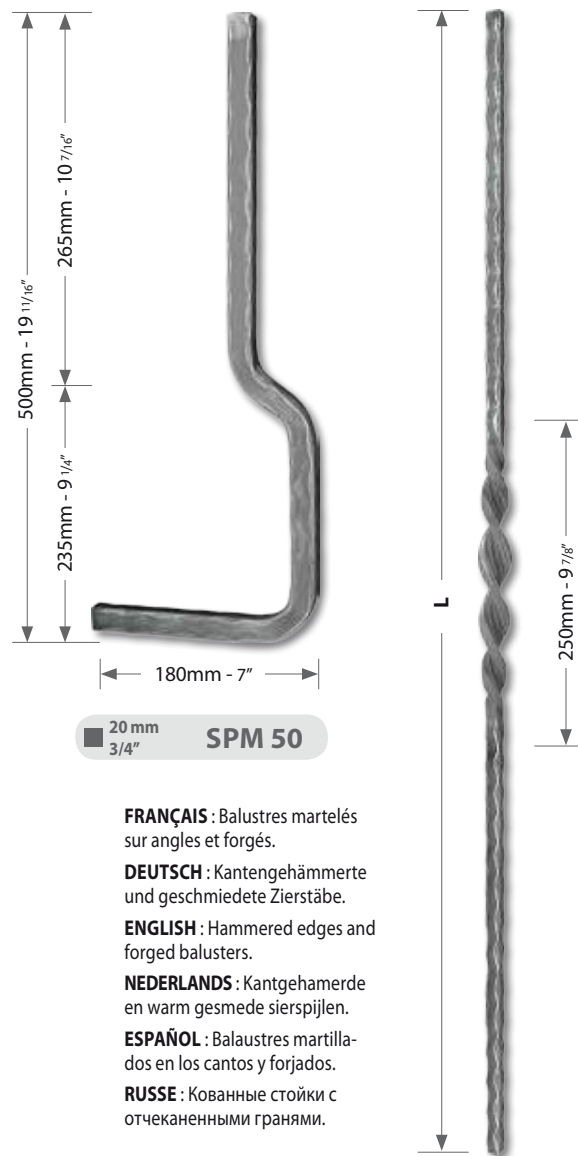

■ 20 mm
3/4" **SPM 50**

FRANÇAIS : Balustres martelés sur angles et forgés.
DEUTSCH : Kantengehämerte und geschmiedete Zierstäbe.
ENGLISH : Hammered edges and forged balusters.
NEDERLANDS : Kantgehamerde en warm gesmede sierspijlen.
ESPAÑOL : Balaustres martillados en los cantos y forjados.
RUSSE : Кованные стойки с отчеканенными гранями.

| | | |
|------------------|----------------------------|---------------|
| ■ 12 mm 1/2" | L : 1000 mm L : 39 3/8" | B 8101 |
| ■ 14 mm 9/16" | L : 1000 mm L : 39 3/8" | B 8102 |
| ■ 14 mm 9/16" | L : 1150 mm L : 45 1/2" | B 8104 |
| ■ 16 mm 5/8" | L : 1150 mm L : 45 1/2" | B 8106 |

RUSTIQUE

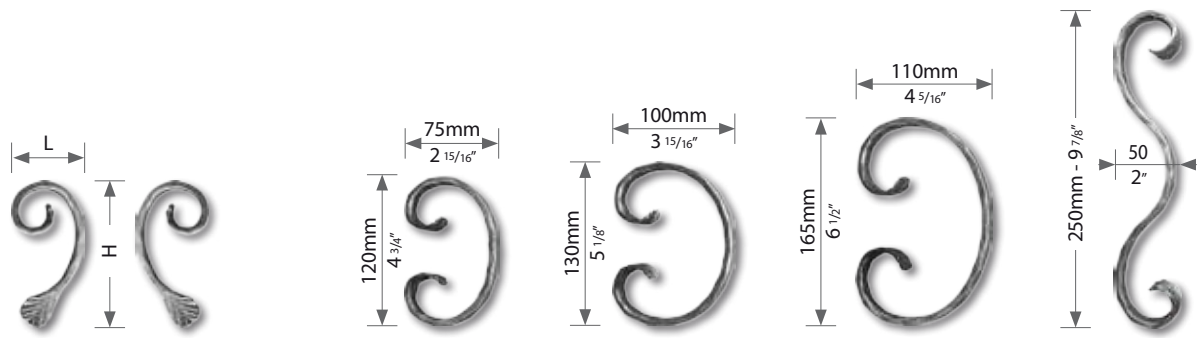

| | | | | | | | |
|----------------------|---------|---------|---|--------|--------|--------|--------|
| 12x6mm 1/2"x1/4" | JM 61 L | JM 61 R | H: 115mm - 4 1/2" L: 60mm - 3 3/8" | CM 121 | CM 131 | CM 161 | LM 251 |
| 14x6mm 9/16"x1/4" | JM 62 L | JM 62 R | H: 115mm - 4 1/2" L: 60mm - 3 3/8" | CM 122 | CM 132 | CM 162 | LM 252 |
| 16x8mm 5/8"x5/16" | JM 64 L | JM 64 R | H: 125mm - 4 15/16" L: 70mm - 2 3/4" | CM 124 | CM 134 | CM 164 | - |

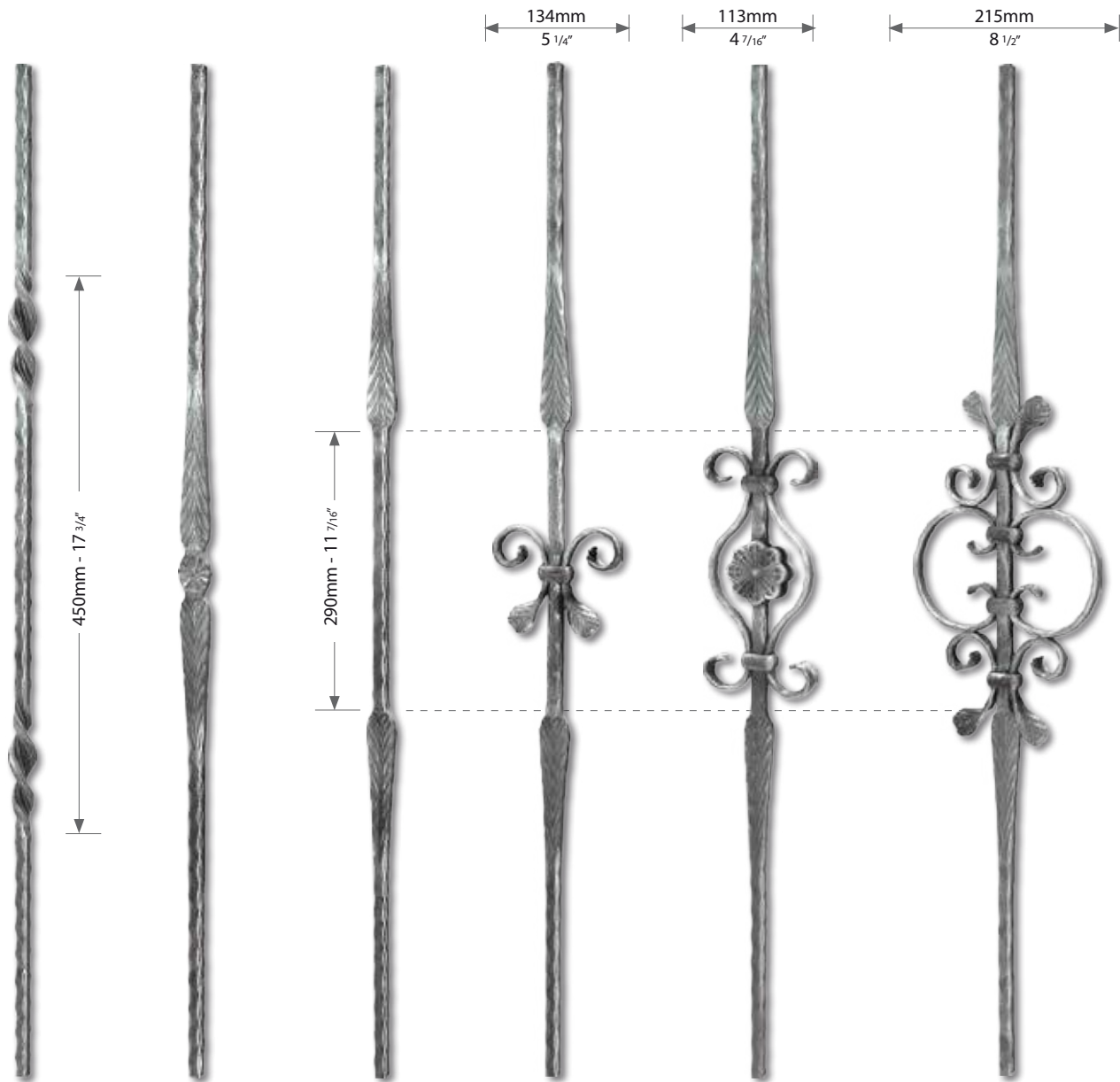

| | | | | | |
|--------|--------|--------|--------|--------|--------|
| B 8201 | B 7101 | B 7201 | B 7401 | B 7501 | B 7601 |
| B 8202 | B 7102 | B 7202 | B 7402 | B 7502 | B 7602 |
| B 8204 | B 7104 | B 7204 | B 7404 | B 7504 | B 7604 |
| B 8206 | B 7106 | B 7206 | B 7406 | - | B 7606 |

CASTEL

FRANÇAIS : Comment résister à ces barreaux ciselés au style très structuré. Ils inspirent une ambiance chaleureuse et authentique.
Balustrés en fer forgé, martelés à froid.

DEUTSCH : Wie man diesen kantigen Geländern mit einem sehr strukturierten Stil widersteht. Sie verleihen eine warme, authentische und beruhigende Atmosphäre. Geländer aus Schmiedeeisen, das kalt gehämmert wurde.

ENGLISH : How to resist these chiseled balusters with a very structured style. They inspire a warm and authentic atmosphere.
Wrought iron balusters, cold hammered.

NEDERLANDS : Hoe je deze gebeitelde balusters kunt weerstaan met een zeer gestructureerde stijl. Ze inspireren een warme en authentieke sfeer.
Smeedijzeren balusters, koud gehamerd.

ESPAÑOL : Cómo resistir estos balaustres cincelados con un estilo muy estructurado. Inspiran un ambiente cálido y auténtico.
Balaustres de hierro forjado, martillados en frío.

RUSSE : Как противостоять этим точеным балясинам с очень структурированным стилем. Они вдохновляют теплую и аутентичную атмосферу.
Балясины из кованого железа, холодного ковки.



CASTEL

99mm
3 15/16"

110mm
4 5/16"

130mm
5 1/8"



| | | | |
|------------------------|----------------|----------------|----------------|
| ■ 12x6mm 1/2"x1/4" | CRC 101 | CRC 111 | - |
| ■ 14x6mm 9/16"x1/4" | CRC 102 | CRC 112 | CRC 132 |

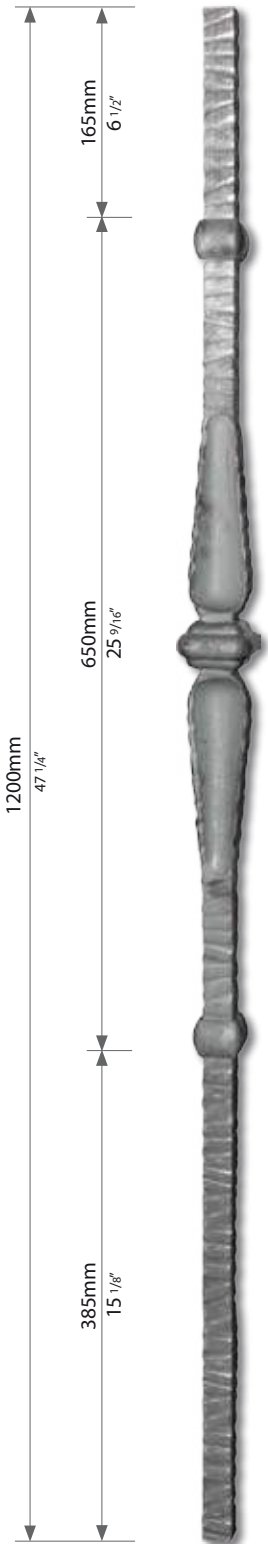

| | |
|-----------------|---------------|
| ■ 20 mm 3/4" | PC 611 |
| ■ 25 mm 1" | PC 612 |



| | | | | | |
|------------------|----------------------------|---------------|---------------|---------------|---------------|
| ■ 12 mm 1/2" | L : 1000 mm L : 39 3/8" | B 6111 | B 6211 | B 6311 | B 6411 |
| ■ 14 mm 9/16" | L : 1000 mm L : 39 3/8" | B 6112 | B 6212 | B 6312 | B 6412 |
| ■ 14 mm 9/16" | L : 1150 mm L : 45 1/2" | B 6114 | B 6214 | B 6314 | B 6414 |

FER

MASTERS

FRANÇAIS : Véritable travail de maître : ces balustres et poteau sont forgés d'une seule pièce au marteau pilon (pas de soudure). De ce fait apparaissent de légères variations dimensionnelles entre les pièces. Les barreaux de longueur 1070 mm sont décentrés de 90 mm.

DEUTSCH : Ein echtes Meisterwerk : Diese Stäbe und Pfosten sind mit einem Schmiedehammer aus einem Stück geschmiedet (keine Schweißstelle). Deshalb treten geringe Maßabweichungen auf. Die 1070 mm langen Stäbe sind ca. 90 mm dezentriert.

ENGLISH : Genuine masterwork : These balusters and post are forged with an air hammer, in one piece (no welding). Therefore there are small dimensional variations. The 1070 mm long balusters are 90 mm off-centered.

NEDERLANDS : Echt meesterwerk. Deze spijlen zijn met een luchthamer uit één stuk gesmeed (geen aangelaste delen). Derhalve kunnen geringe maatafwijkingen voor komen. De 1070 mm lange spijlen zijn op 90 mm gedecentreerd.

ESPAÑOL : Verdadera trabajo de maestro : Estos balaustres y arranques están forjados de una sola pieza con martillo pilón (Sin soldaduras). De hecho pueden apreciarse ligeras variaciones de medidas entre las piezas. Las barras de longitud 1070 mm. tienen el ornamento descentrado 90 mm.

RUSSE : Великолепная ручная работа - стойки выкованы при помощи пневматического молота как единое целое (без сварки), именно поэтому разброс их размеров невелик. Стойки длиной 1070 мм с эксцентрично расположенными утолщениями в 90 мм.



MASTERS



TB 200

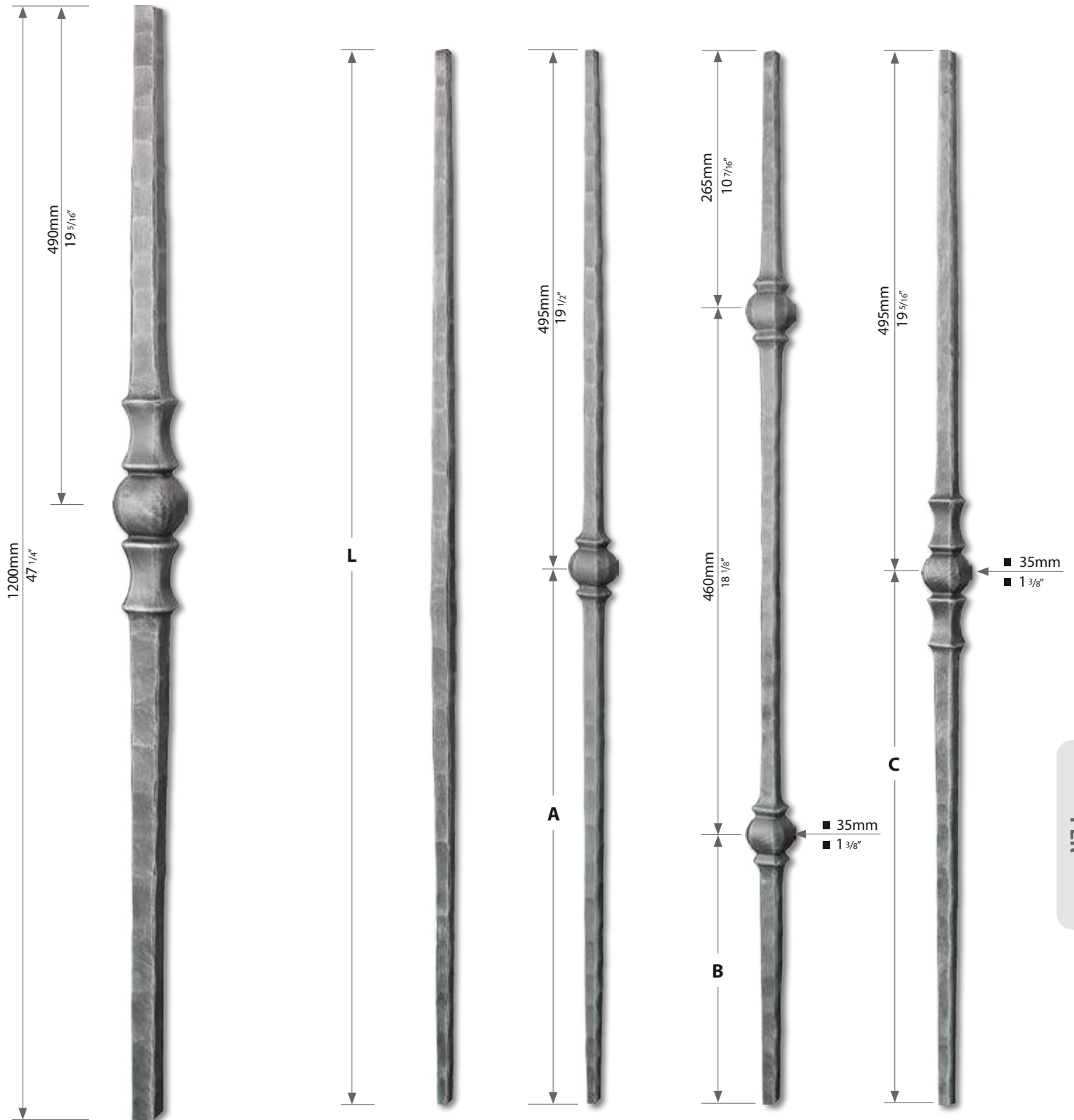

■ 25 mm
1" **P 202**

| | | | | | | | | |
|------------------------|----------------------------|---------------|-----------------------------|---------------|----------------------------|---------------|-----------------------------|---------------|
| ■ 10-13 mm 3/8-1/2" | L : 950 mm L : 38" | B 2002 | A : 455 mm A : 17 15/16" | B 2102 | B : 225 mm B : 8 7/8" | B 2202 | C : 455 mm C : 17 15/16" | B 2302 |
| ■ 10-13 mm 3/8-1/2" | L : 1070 mm L : 42 1/8" | B 2003 | A : 575 mm A : 22 5/8" | B 2103 | B : 345 mm B : 13 9/16" | B 2203 | C : 575 mm C : 22 5/8" | B 2303 |

FER

VENEZIA

VZA 1
16x8mm
5/8"x5/16"

VZA 2
16x8mm
5/8"x5/16"

VZM 1
16mm
5/8"

VZP200
20x8mm
13/16"x5/16"

PR 565
30mm
1 3/16"

BR 572
14mm
9/16"

BR 573
16mm
5/8"

| | | |
|-----------------|---------------------------|---------------|
| ● 14mm 9/16" | A = 101 mm A = 4" | D 82 R |
| ● 16mm 5/8" | A = 103 mm A = 4 1/16" | D 83 R |

| | | | |
|--------------|------------|----------|------------|
| EG 14 | Ø: 14,5 mm | H: 23 mm | D: 34 mm |
| | Ø: 9/16" | H: 7/8" | D: 1 5/16" |
| EG 16 | Ø: 17 mm | H: 23 mm | D: 38 mm |
| | Ø: 11/16" | H: 7/8" | D: 1 1/2" |



Exemple d'utilisation - Illustration
 Voorbeelden voor toepassingen
 Anwendungsbeispiel - Ejemplo de empleo
 Пример использования

ACCESSOIRES ET DÉPART DE RAMPE

FRANÇAIS : Equerre en acier moulé. Fixation du barreau par soudage ou vissage. Livré avec une vis à deux filets 10mm.

DEUTSCH : Schmiedeguß Winkel. Befestigung des Stabs per Schweißen oder Aufschrauben. Geliefert mit einer Schraube mit 10 mm Doppel-Gewinde.

ENGLISH : Steel angle bracket. Fix the baluster in place by means of welding or screwing. Supplied with a 10 mm double thread screw.

NEDERLANDS : Vierkante hoekijzer. Bevestigd de balustrade op de plaats door middel van lassen of schroeven. Geleverd met een 10mm dubbele draad schroef.

ESPAÑOL : Escuadra de acero moldeado. Fijación al barrote por soldadura o atornillada. Se suministra con tornillo de doble rosca de 10mm.

RUSSE : Литое боковое крепление из стали. Крепление баясин возможно с помощью сварки или винтов. Комплектуется с двухсторонним винтом 10мм.



SUP 6

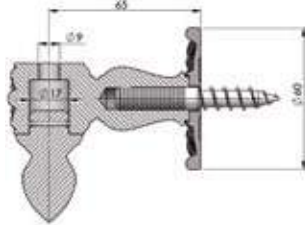

FRANÇAIS : Pour fixer les balustres latéralement sur le limon : Support en fer avec trous ovales et pièce de recouvrement en fonte grise. **INAPTE À LA GALVANISATION.**

DEUTSCH : Zum seitlichen Aufschrauben der Stäbe auf die Wange : Stahlträger mit ovalen Bohrungen – Abdeckrossette aus Grauguß. **UNGEEIGNET FÜR FEUERVERZINKUNG.**

ENGLISH : To fix balusters on the side of the stringer : Steel bracket with oval holes and cast iron cap. **NOT SUITABLE FOR HOT DIP GALVANIZING.**

ESPAÑOL : Para fijar los balaustres lateralmente en la zanca . Soporte de hierro con agujeros ovalados y pieza de recubrimiento en fundición gris. **NO APTAS PARA LA GALVANIZACIÓN.**

RUSSE : Для крепления баясин на косоуре: боковое крепление из стали в комплекте с декоративной пластиной из серого чугуна. **Не пригодно для цинкования.**

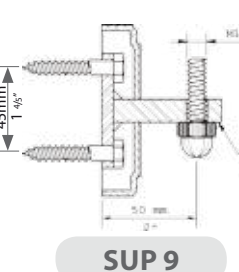

FRANÇAIS : Socles de raccordement en fer, seuls, permettant également le montage des têtes de départ des pages 64 et 65. **GALVANISABLE.**

DEUTSCH : Pfostensockel aus Eisen, einzeln : Erlaubt auch die Montage der Zierköpfe auf den Seiten 64 und 65. **FEUERVERZINKBAR.**

ENGLISH : Steel finial base, alone : Also allow for the mounting of the finials on pages 64 and 65. **SUITABLE FOR HOT DIP GALVANIZING**

NEDERLANDS : Baluster aansluitsockel uit ijzer : alleen voor de montage van de sierkoppen, zie ook de pagina's 64 en 65. **VERZINKBAAR.**

ESPAÑOL : Zócalo de pedestal en hierro, suelto. Permite también el montaje con los cabezales de arranque de las paginas 64 y 65. **GALVANIZABLES.**

RUSSE : Соединительные цоколи, основания из стали, которые можно использовать при монтаже вместе с навершиями, которые представлены на страницах 64 и 65.

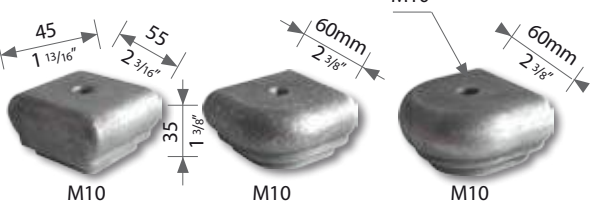

TS 6
Embase passante
Passing base
Durchlassender Sockel
Doorlopend deel
Base pasante
Прходное основание

TS 5
Embase d'angle
Base for angle
Winkelsockel
Hoekstuk
Base de ángulo
Угловое основание

TS 4
Embase d'extrémité
Extremity base
Anfangssockel
Begindeel
Base de extremo
Торцевое основание

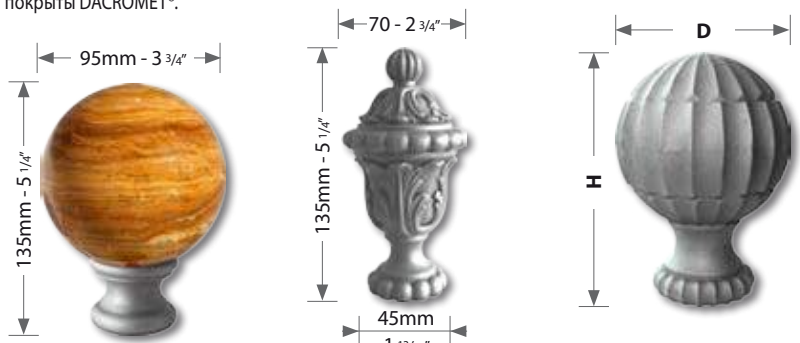

TP 54
Boule en ONYX - ONYX Kugel
ONYX sphere - OXYX bolle
ÓNICE bola - Шар из ОНИКА

| | | | | |
|-----|------------------|------------------------|-------------------------|------------------|
| M10 | FOT 13 | D: 80 mm D: 3 1/8" | H: 120 mm H: 4 3/4" | TB 200 |
| M10 | FOT 13 ZD | D: 80 mm D: 3 1/8" | H: 120 mm H: 4 3/4" | TB 200 ZD |
| M10 | - | D: 110 mm D: 3 1/8" | H: 154 mm H: 6 1/16" | TB 300 |

FRANÇAIS : Têtes de départ de rampe, montées sur un socle en fer brut, prêt à être soudé sur le poteau. **GALVANISABLES.** Au choix pour extrémité, angle ou passage.

DEUTSCH : Zieraufsätze für Anfangsstäbe, montiert auf einen Roheisensockel, zum Aufschweißen. **FEUERVERZINKBAR.** Zur Wahl Anfangs-, Winkel- oder durchlassender Sockel.

ENGLISH : Starting post finials, mounted on an steel base, ready to be welded on the post. **SUITABLE FOR HOT DIP GALVANIZING.** To choose between extremity, angle or passing base.

ESPAÑOL : Cabezales de barandilla montados sobre un zócalo de hierro en bruto, listo para soldar sobre el balaustre. **GALVANIZABLES.** base a elegir para extremo, ángulo o pasante.

RUSSE : Навершия установленные на стальные необработанные основания. Готовы к привариванию к столбам. **Пригодны для цинкования.** На выбор: торцевые, угловые, проходные.

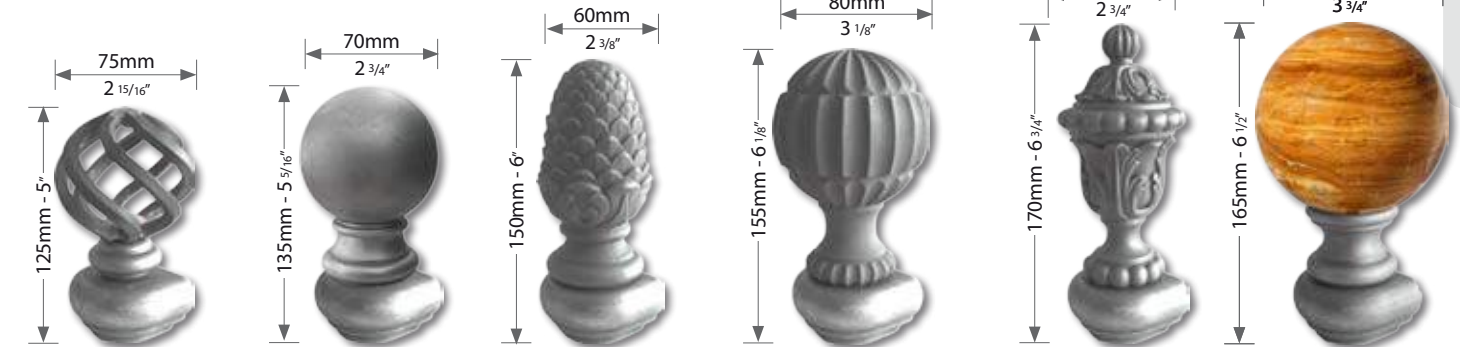

| | | | | | | | | | | |
|--------------|--------------------|--------------|----------------|---------------|---|---------------|-----------------|---------------|-----------------|--------------|
| TZ 72 | Embase d'extrémité | TF 70 | Extremity base | TF 120 | Anfangssockel Торцевое основание | TS 201 | Begindeel | TF 130 | Base de extremo | TP 80 |
| TZ 75 | Embase d'angle | TF 75 | Base for angle | TF 125 | Winkelsockel Угловое основание | TS 205 | Hoekstuk | TF 135 | Base de ángulo | TP 85 |
| TZ 76 | Embase passante | TF 76 | Passing base | TF 126 | Durchlassender Sockel Прходное основание | TS 206 | Doorlopend deel | TF 136 | Base pasante | TP 86 |

MAINS COURANTES - HANDLÄUFE - HANDRAILS

FRANÇAIS : Départs de rampe "LATERAL", en acier moulé. Livrés avec une sous-lisse en fer plat de 20/12 mm.

DEUTSCH : "LATERAL" Anfangsstücke aus Schmiedeguß. Geliefert mit einem 20/12 mm Untergurt.

ENGLISH : "LATERAL" rail ends, made of cast steel. Supplied with a 20/12 mm (3/4" x 1/2") steel scroll.

NEDERLANDS : "LATERAL" eindstuk uit smeedijzer, in linkse en rechte uitvoering. Geleverd met een plat profiel 20/12 mm.

ESPAÑOL : Arranque de barandilla "LATERAL", en acero moldeado. Se suministra con pletina inferior de 20/12 mm.

RUSSE : «Бокковые» завитки поручня отлитые из стали. Поставляются в комплекте со стальной

FRANÇAIS : "LATERAL" pour la lisse inférieure en fer plat 20 x 12 mm. Utilisable à gauche ou à droite.

DEUTSCH : "LATERAL" für Untergurt aus 20 x 12 mm Flacheisen. Rechts und Links verwendbar.

ENGLISH : "LATERAL" bottom rail scroll, made of a 20 x 12 mm (3/4" x 1/2") steel bar. For left and right use.

NEDERLANDS : "LATERAL" eindkrullen uit 20 x 12 mm. Ijzer voor aan onderprofiel te lassen. Zowel links als rechts toepasbaar.

ESPAÑOL : "LATERAL" para pletina inferior en hierro de 20 x 12 mm. Utilizable a izquierda y derecha.

RUSSE : Основание для левых и правых «БОКОВЫХ» завитков перил. Изготовлены из стальной полосы 20 x 12 мм.

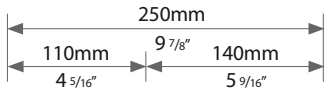

DR 245 L

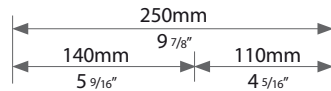

DR 245 R



■ 20 x 12mm (3/4" x 1/2")

DR 246



ca. 900mm - ca. 35 1/2"

DR 95

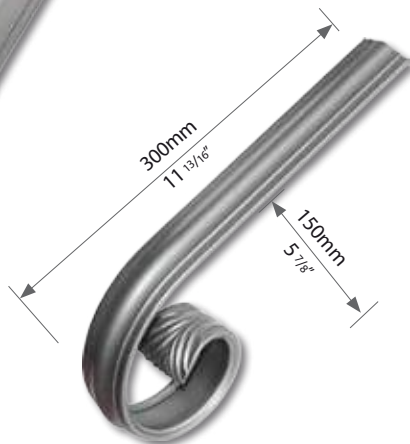

DR 35

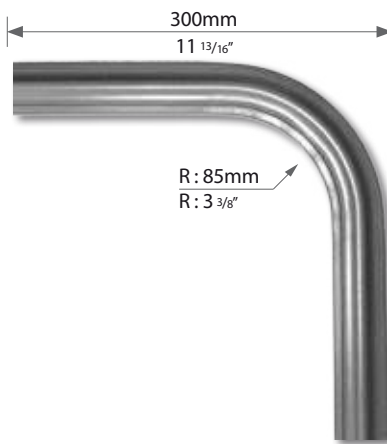

CO 75

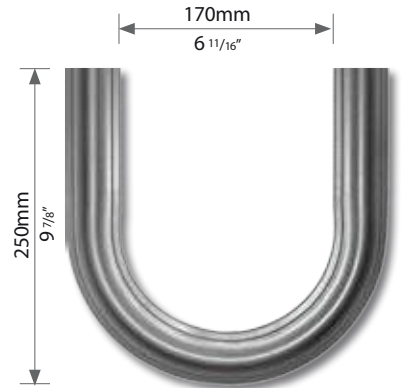

CU 165

FRANÇAIS : Bague couvre-joint en acier moulé.

DEUTSCH : Fugenabdeckbund aus Schmiedeguß.

ENGLISH : Steel castings coverjoint collar.

NEDERLANDS : Smeedbaar gietijzeren koppelstuk voor handgreep.

ESPAÑOL : Abrazadera tapajuntas en acero moldeado

RUSSE : Соединительные элементы из литой стали.



RA 40



DRC 305

Pour/Für/For/Для MC 305

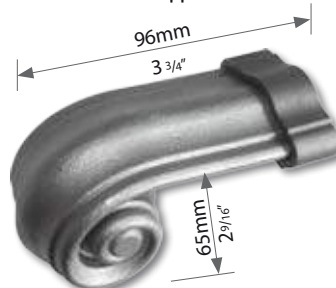

DR 305

FRANÇAIS : Main courante en fer mouluré. Livrée en longueurs de 3/6 mètres.

DEUTSCH : Handlaufprofil aus Stahl. Geliefert in Längen von 3/6 Metern.

ENGLISH : Formed steel handrail. Supplied in 3/6 meter (ca. 10 ft.) lengths.

NEDERLANDS : Handgreep uit ijzer, met sponning voor onderstrip. Leverbaar in lengtes van 3/6 meter.

ESPAÑOL : Pasamanos en hierro moldurado. Se sirve en 3/6 metros de longitud.

RUSSE : Профилированные стальные перила. Поставляются в виде заготовок длиной по 3/6 метра.

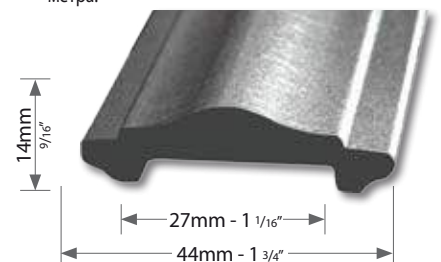

L: ca. 3 m.
L: ca. 10 ft.
L: ca. 6 m.
L: ca. 20 ft.

MC 305

MC 605

HANDGREPEN - PASAMANOS - ПЕРИЛА

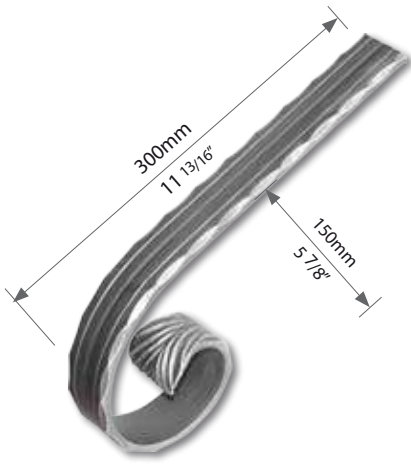

DR 30

FRANÇAIS : Main courante en plat 40 x 8 mm martelé. Livrée en longueurs de 3/6 mètres.

DEUTSCH : Gehämmertes Handlaufprofil aus 40 x 8 mm. Geliefert in Längen von ca. 3/6 Metern.

NEDERLANDS : Gehamerde handgreep, plat 40 x 8 mm. Leverbaar in lengtes van 3/6 meter.

ENGLISH : Hammered handrail made of 40 x 8 mm (1 9/16" x 5/16") steel bar. Supplied in 3/6 meter (ca. 10 ft.) lengths.

ESPAÑOL : Pasamanos en pletina de 40 x 8 martilleada. Se sirve en 3/6 metros de longitud.

RUSSE : Перила с чеканкой, изготовлены из стальной полосы 40 x 8 мм. Поставляются в виде заготовок длиной по 3/6 метра.



| | | |
|-------------------|----------------|---------------|
| ■ 40 x 8 mm | L : ca. 3 m. | MC 300 |
| ■ 1 9/16" x 5/16" | L : ca. 10 ft. | |
| ■ 40 x 8 mm | L : ca. 6 m. | MC 600 |
| ■ 1 9/16" x 5/16" | L : ca. 20 ft. | |

FRANÇAIS : Support-cavalier de main courante, livré sans vis.
DEUTSCH : Handlaufträger, Lieferung ohne Schrauben.
ENGLISH : Forged handrail bracket. Delivered without screws.
NEDERLANDS : Muurleuninghouder, exclusief schroeven.
ESPAÑOL : Soporte para pasamanos. Se suministra sin tornillos.
RUSSE : Кованые кронштейны для перил. Поставляются без крепежных винтов.

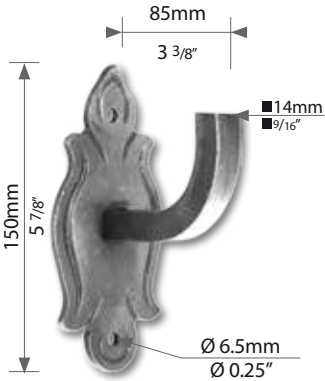

SMC 5

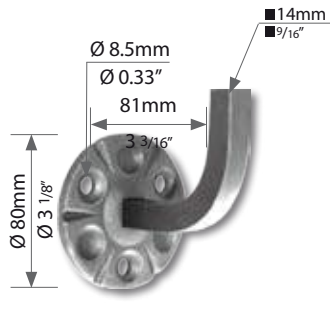

SMC 3

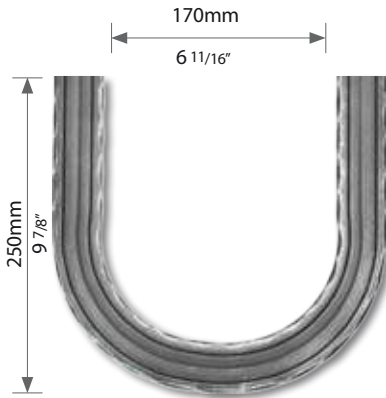

CU 160

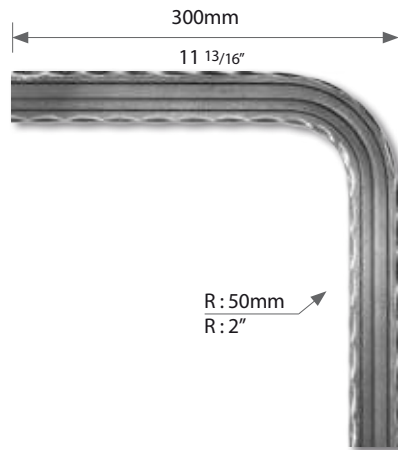

CO 70

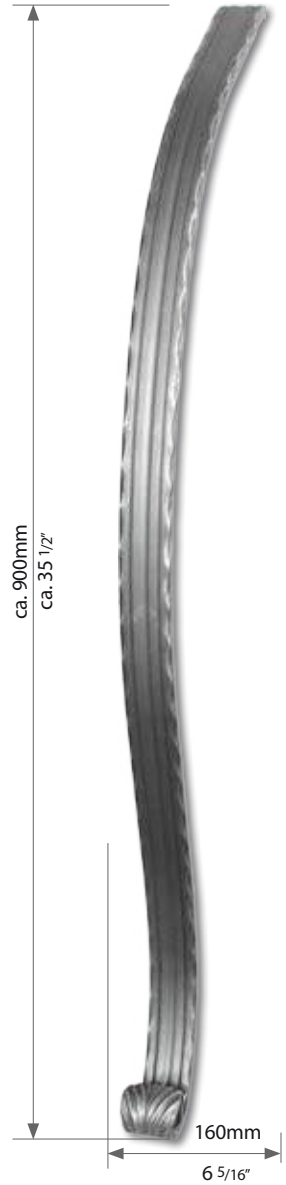

DR 90

FER



Livrée brute.
 Bruttolieferungen.
 Raw deliveries.
 rauwe livrei.
 Entregas brutas.
 Валовые поставки.



Longueur 1000 mm
 Lengths 39 3/8" **MC-F1-1000**



Longueur 1500 mm
 Lengths 58 5/8" **MC-F1-1500**



Longueur 2000 mm
 Lengths 78" **MC-F1-2000**



Longueur 3000 mm
 Lengths 10 ft. **MC-F1-3000**

BARREAUX FORGES - GESCHMIEDETE ZIERSTÄBE - FORGED BARS GESMEEDE SIERSTAVEN - BALAUSTRES FORJADOS - КОВАННЫЕ ПИКИ

FRANÇAIS : Barreaux **CARRÉS** forgés pour clôture.

DEUTSCH : Geschmiedete **VIERKANT** Zierstäbe für Zaun.

ENGLISH : Forged **SQUARE** balusters for fence.

NEDERLANDS : Gesmede **VIERKANTE** balusters voor een hekwerk.

ESPAÑOL : Balaustres forjados **CUADRADOS** para clotura.

RUSSE : Кованые пики квадратной формы для ограждений.

FRANÇAIS : Barreaux **RONDS** forgés pour clôture.

DEUTSCH : Geschmiedete **RUNDE** Zierstäbe für Zaun.

ENGLISH : Forged **ROUND** balusters for fence.

NEDERLANDS : Gesmede **RUNDE** balusters voor een hekwerk.

ESPAÑOL : Balaustres forjados **REDONDO** para clotura.

RUSSE : Кованые пики круглой формы для ограждений.

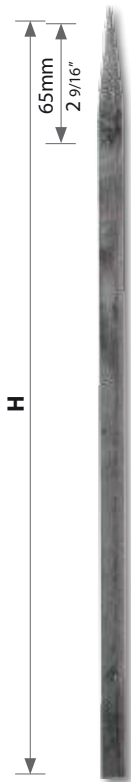

| | | |
|-----------------|---------------------------|-------------------|
| 14 mm 9/16" | H : 200mm H : 7 7/8" | LAC14-200 |
| 16 mm 5/8" | H : 200mm H : 7 7/8" | LAC16-200 |
| 16 mm 5/8" | H : 1200mm H : 47 1/4" | LAC16-1200 |
| 16 mm 5/8" | H : 2000mm H : 78 3/4" | LAC16-2000 |
| 18 mm 11/16" | H : 200mm H : 7 7/8" | LAC18-200 |
| 18 mm 11/16" | H : 1200mm H : 47 1/4" | LAC18-1200 |
| 18 mm 11/16" | H : 2000mm H : 78 3/4" | LAC18-2000 |
| 20 mm 13/16" | H : 200mm H : 7 7/8" | LAC20-200 |
| 20 mm 13/16" | H : 1400mm H : 55 1/8" | LAC20-1400 |
| 20 mm 13/16" | H : 2000mm H : 78 3/4" | LAC20-2000 |



| | | |
|-----------------|---------------------------|-------------------|
| 14 mm 9/16" | H : 200mm H : 7 7/8" | LAR14-200 |
| 14 mm 9/16" | H : 600mm H : 23 5/8" | LAR14-600 |
| 14 mm 9/16" | H : 1200mm H : 47 1/4" | LAR14-1200 |
| 16 mm 5/8" | H : 200mm H : 7 7/8" | LAR16-200 |
| 16 mm 5/8" | H : 1200mm H : 47 1/4" | LAR16-1200 |
| 16 mm 5/8" | H : 2000mm H : 78 3/4" | LAR16-2000 |
| 18 mm 11/16" | H : 200mm H : 7 7/8" | LAR18-200 |
| 18 mm 11/16" | H : 1200mm H : 47 1/4" | LAR18-1200 |
| 18 mm 11/16" | H : 2000mm H : 78 3/4" | LAR18-2000 |
| 20 mm 13/16" | H : 200mm H : 7 7/8" | LAR20-200 |
| 20 mm 13/16" | H : 1400mm H : 55 1/8" | LAR20-1400 |
| 20 mm 13/16" | H : 2000mm H : 78 3/4" | LAR20-2000 |



| | | |
|-----------------|--------------------------|--------------|
| 14 mm 9/16" | H : 83mm H : 3 3/8" | LAD14 |
| 16 mm 5/8" | H : 95mm H : 3 3/4" | LAD16 |
| 18 mm 11/16" | H : 106mm H : 4 3/16" | LAD18 |
| 20 mm 13/16" | H : 120mm H : 4 3/4" | LAD20 |

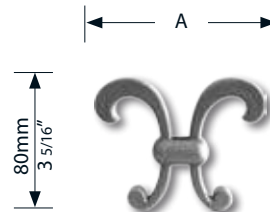

| | | |
|----------------|---------------------------|---------------|
| 12 mm 1/2" | A = 104 mm A = 4 1/8" | D 81 K |
| 14 mm 9/16" | A = 106 mm A = 4 3/16" | D 82 K |

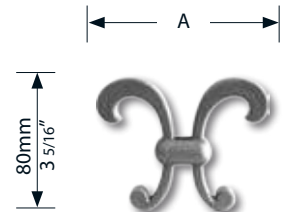

| | | |
|----------------|---------------------------|---------------|
| 14 mm 9/16" | A = 101 mm A = 4" | D 82 R |
| 16 mm 5/8" | A = 103 mm A = 4 1/16" | D 83 R |

FRANÇAIS : Traverses à trous. **Long. : 2 mètres**
DEUTSCH : Gelochte Gitterstäbe. **Länge : 2 Meter**
ENGLISH : Cross bars. **Length : 2 meters (78")**

NEDERLANDS : Hole dwarsliggers. **Long. : 2 meter**
ESPAÑOL : Traviesas perforadas. **Long. : 2 metros.**
RUSSE : Дырки шпал. **Long. : 2 метра**

| | | |
|---------------------|-------------------------|--------------------|
| A=14 mm A=9/16" | 30x8mm 1 3/16"x5/16" | TTC 308-14 |
| A=16 mm A=5/8" | 40x8mm 1 9/16"x5/16" | TTC 408-16 |
| A=18 mm A=11/16" | 40x8mm 1 9/16"x5/16" | TTC 408-18 |
| A=20 mm A=3/4" | 40x10mm 1 9/16"x3/8" | TTC 4010-20 |



| | | |
|---------------------|-------------------------|--------------------|
| D=14 mm D=9/16" | 30x8mm 1 3/16"x5/16" | TTR 308-14 |
| D=16 mm D=5/8" | 30x8mm 1 3/16"x5/16" | TTR 308-16 |
| D=18 mm D=11/16" | 40x8mm 1 9/16"x5/16" | TTR 408-18 |
| D=20 mm D=3/4" | 40x10mm 1 9/16"x3/8" | TTR 4010-20 |

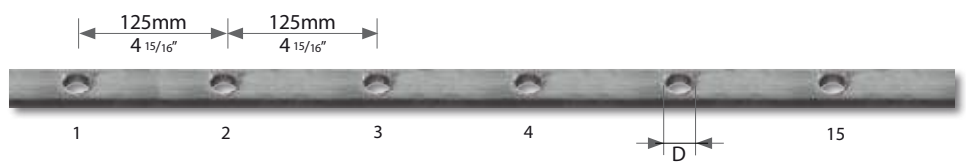

TRAVERSES - GITTERSTÄBE - CROSS BARS - DWARSSTAVEN - TRAVIESAS - ПОПЕРЕЧИНЫ

FRANÇAIS : Traverses crantées forgées à chaud. Sur la face avant, un décor à pointes de diamant ou à rosettes. A l'arrière, des encoches de 14,5 x 14,5 mm.

DEUTSCH : Warm geschmiedete Querstangen. Auf der Vorderseite Zierköpfe, auf der Rückseite ermöglichen die Hohlkehlen (14,5 x 14,5 mm) ein schnelles Zusammensetzen.

ENGLISH : Forged cross bars : On the front, a nailhead ornamentation. At the back, 14,5 x 14,5 mm notches which allow for easy and rapid positioning.

NEDERLANDS : Warm gesmede verbindingsprofielen. Aan de voorzijde met sierrozetten, uithollingen aan de achterzijde, geschikt voor spijlen van 14 mm. Voor een snelle samenstelling van hekwerk.

ESPAÑOL : Traviesas dentadas forjadas en caliente. Adornos en forma de punta de diamante ó de roseta en la cara anterior. En la parte posterior alojamientos de 14,5 x 14,5 mm.

RUSSE : Кованые поперечины: слицевой стороны украшены элементами, имитирующими шляпки декоративных гвоздей. С обратной стороны предусмотрены пазы 14,5 x 14,5 мм.

TRADITION

| | | |
|-----------------------|-----------------------|--------------|
| 14 mm 9/16" | E: 14,5mm E: 9/16" | T 201 |
| 20x15 mm 3/4x9/16" | E: 14,5mm E: 9/16" | T 202 |
| 20x15 mm 3/4x9/16" | E: 16,5mm E: 5/8" | T 206 |

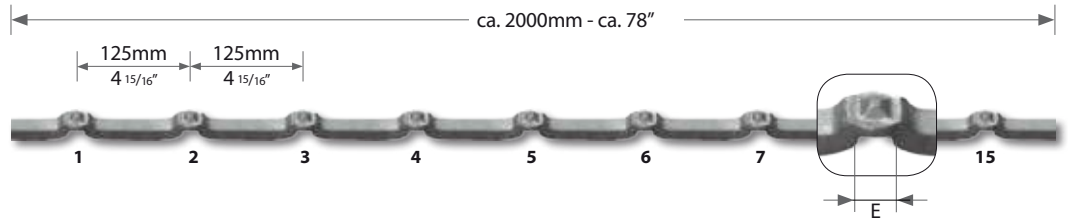

RUSTIQUE

| | | |
|-----------------------|-----------------------|---------------|
| 14 mm 9/16" | E: 14,5mm E: 9/16" | TM 201 |
| 20x15 mm 3/4x9/16" | E: 14,5mm E: 9/16" | TM 202 |
| 20x15 mm 3/4x9/16" | E: 16,5mm E: 5/8" | TM 206 |

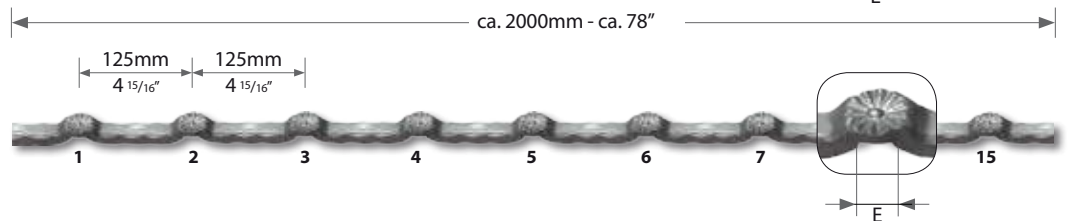

FRANÇAIS : Traverses à trous renflés, forgés à chaud. **Long. : 2 mètres**
DEUTSCH : Gelochte Gitterstäbe, warm geschmiedet. **Länge : 2 Meter**
ENGLISH : Cross bars with hot forged holes. **Length : 2 meters (78")**

NEDERLANDS : Dwars staven met hete gesmede gaten : **Long. : 2 meter**

ESPAÑOL : Traviesas perforadas de nudo abultado, forjadas en caliente. **Long. : 2 metros.**

RUSSE : Кованые поперечины с отверстиями. **Длина: 2 метра**

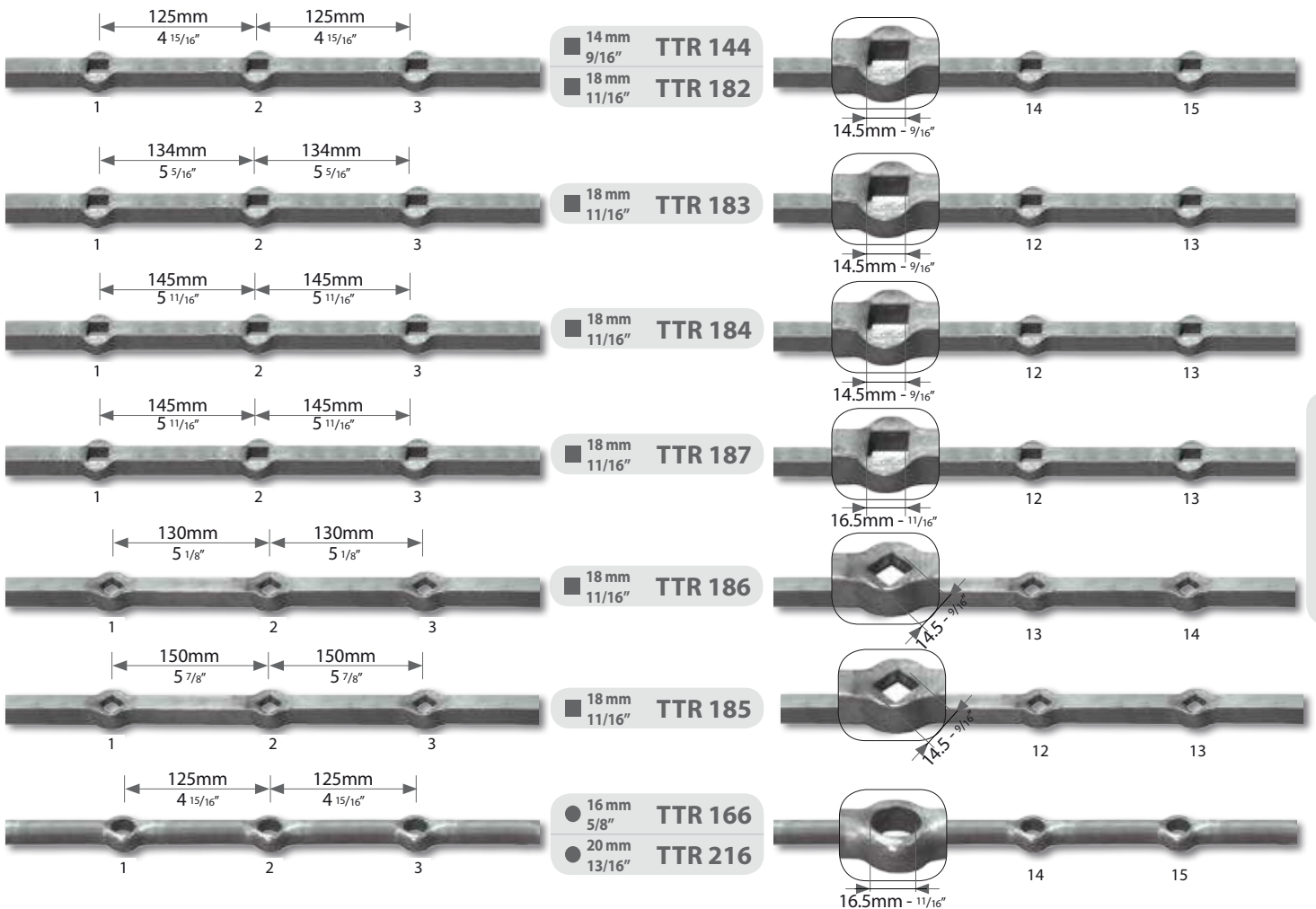

FER

ACCESSOIRES - ZUBEHÖR - ACCESSORIES TOEBEHOREN - ACCESORIOS - АКЦЕССУАРЫ

FRANÇAIS : Vis de sécurité en acier trempé à SENS UNIQUE : Dévissage au tournevis impossible.

DEUTSCH : Einweg-Sicherheits-Schraube aus gehärtetem Stahl. Die Schrauben können nicht mehr herausgedreht werden.

ENGLISH : One way security screw, heat treated (5/16" x 3"). Unscrewing will be impossible.

NEDERLANDS : Veiligheidsschroef uit gehard staal. Deze kan na montage niet meer los gedraaid worden.

ESPAÑOL : Tornillo unidireccional de seguridad de acero templado : Una vez atornillado ya no puede destornillarse.

RUSSE : Неотвинчиваемый предохранительный винт со штампованной горячим способом резьбой. Открутить невозможно.

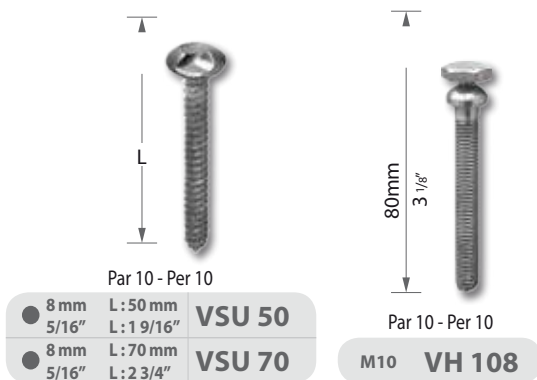

FRANÇAIS : Vis de sécurité indéserrable, par rupture de la tête hexagonale.

DEUTSCH : Abscheer-Sicherheits-Schraube. Sechskant-Kopf reißt bei einem bestimmten Druckpunkt ab.

ENGLISH : Security lock screw, by breaking off the hexagonal head.

NEDERLANDS : Veiligheidsbout met zeskkante kop die na montage is afgedraaid. Daarna is de bout niet meer te demonteren.

ESPAÑOL : Tornillo de seguridad indestructible si se rompe la cabeza hexagonal.

RUSSE : Предохранительный винт с шестигранной головкой.

FRANÇAIS : Patte de scellement pour traverses.

DEUTSCH : Befestigungsanker für Lochstäbe.

ENGLISH : Sealing lug for pierced bars.

NEDERLANDS : Bevestigingsanker om in te metselen, geschikt voor verbindingsprofielen.

ESPAÑOL : Terminación de adorno para traviesas perforadas de nudo abultado.

RUSSE : Кронштейн для поперечин.

FRANÇAIS : Platine de fixation pour traverses de grilles. Fournie avec 2 trous lamés Ø 11 mm pour vis VSU 70 ou VH 108. (Visserie à commander à part).

DEUTSCH : Befestigungsanker zum Aufdübeln der Quertraversen. Lieferung mit zwei Ø 11 mm Bohrungen passend zu VSU 70 und VH 108. (Schrauben müssen separat bestellt werden).

ENGLISH : Clamping plate for cross bars. Supplied with 2 Ø 11 mm holes matching VSU 70 or VH 108 screws. (Must be ordered separately).

NEDERLANDS : Bevestigingsrozet voor verbindingsprofielen. Uitgevoerd met 2 gaten Ø 11 mm, geschikt voor pluggen VSU 70. (Exclusief schroeven en pluggen, deze separaat bestellen).

ESPAÑOL : Placa de fijación para barras transversales. Dispone de dos orificios de Ø 11 mm para tornillos VSU 70 ó VH 108. (El pedido debe realizarse por separado).

RUSSE : Защёлка для поперечин. Изготавливается с двумя отверстиями Ø 11 мм под винты VSU70 и VH 108. Поставляется по дополнительному заказу.

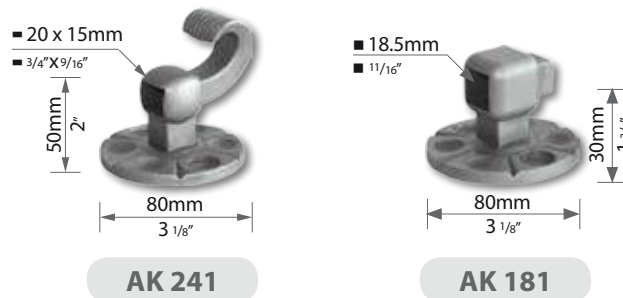
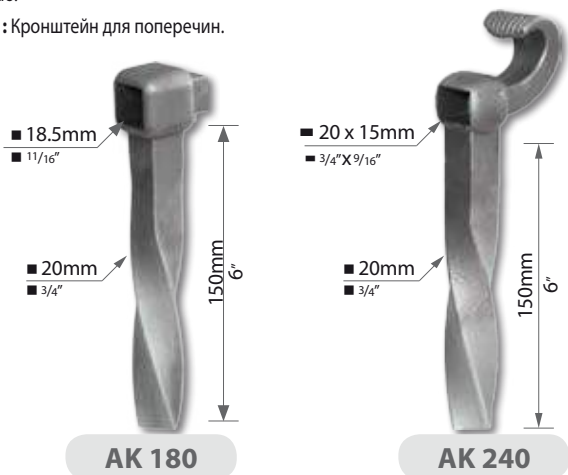

CARRÉ DE FER- QUADRAT AUS EISEN - SQUARE OF IRON VIERKANT VAN IJZER- CUADRADO DE HIERRO - КВАДРАТ ЖЕЛЕЗА

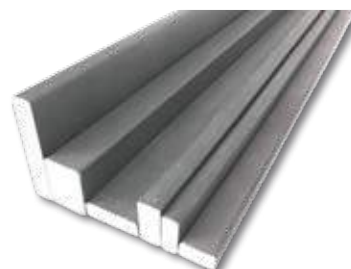

| | Longueur Length | Longueur Length | Longueur Length |
|------------------|--------------------|--------------------|--------------------|
| | 1000 mm 39 3/8" | 2000 mm 78 3/4" | 3000 mm 10 ft. |
| ■ 12 mm 1/2" | C12-1M | C12-2M | C12-3M |
| ■ 14 mm 9/16" | C14-1M | C14-2M | C14-3M |
| ■ 16 mm 5/8" | C16-1M | C16-2M | C16-3M |
| ■ 20 mm 3/4" | C20-1M | C20-2M | C20-3M |
| ■ 25 mm 1" | C25-1M | C25-2M | C25-3M |

| | Longueur Length | Longueur Length | Longueur Length |
|---------------------------|--------------------|--------------------|--------------------|
| | 1000 mm 39 3/8" | 2000 mm 78 3/4" | 3000 mm 10 ft. |
| ■ 12 x 6mm 1/2" x 1/4" | PLAT12-6-1M | PLAT12-6-2M | PLAT12-6-3M |
| ■ 14x6mm 9/16" x 1/4" | PLAT14-6-1M | PLAT14-6-2M | PLAT14-6-3M |
| ■ 20x6mm 3/4" x 1/4" | PLAT20-6-1M | PLAT20-6-2M | PLAT20-6-3M |
| ■ 20x15mm 3/4" x 9/16" | PLAT20-15-1M | PLAT20-15-2M | PLAT20-15-3M |
| ■ 16x8mm 5/8" x 5/16" | PLAT16-8-1M | PLAT16-8-2M | PLAT16-8-3M |

ROND DE FER - RUNDE EISEN - ROUND OF IRON
 RONDE VAN IJZER - RONDA DE HIERRO - ЖЕЛЕЗНЫЙ КРУГ

| | Longueur Length | Longueur Length | Longueur Length |
|------------------|--------------------|--------------------|--------------------|
| | 1000 mm 39 3/8" | 2000 mm 78 3/4" | 3000 mm 10 ft. |
| ● 14 mm 9/16" | R14-1M | R14-2M | R14-3M |
| ● 16 mm 5/8" | R16-1M | R16-2M | R16-3M |
| ● 18 mm 5/8" | R18-1M | R18-2M | R18-3M |
| ● 30 mm 3/4" | R30-1M | R30-2M | R30-3M |



BARRES MARTELEES - GEHÄMMERTES EISEN- HAMMERED BARS
 GEHAMERDE STAVEN - BARRAS MATILLADAS - ПЕРИЛА С ЧЕКАНКОЙ

FRANÇAIS : Fers martelés sur les angles.
 Livrés en longueurs de 3 mètres environ.

ENGLISH : Steel bars, with hammered edges.
 Available in lengths of ca. 3 meters. (9,85')

ESPAÑOL : Hierros martillados en los angulos.
 Suministrados en longitud de 3 metros.

DEUTSCH : Eisen, Kanten gehämmert.
 Lieferbar in Längen von ca. 3 Metern.

NEDERLANDS : Kantgehamerd ijzer. Leverbaar
 in lengten van ca. 3 meter.

RUSSE : Стальные прутки с чеканкой по
 краям. Поставляются в виде заготовок
 длиной по 3 метра.



| | |
|-------------------------|---------------|
| ■ 12 mm 1/2" | HR 120 |
| ■ 14 mm 9/16" | HR 140 |
| ■ 16 mm 5/8" | HR 160 |
| ■ 20 mm 3/4" | HR 200 |
| ■ 25 mm 1" | HR 250 |
| ■ 12x6mm 1/2"x1/4" | HR 126 |
| ■ 14x6mm 9/16"x1/4" | HR 146 |
| ■ 20x6mm 3/4"x1/4" | HR 206 |
| ■ 20x15mm 3/4"x9/16" | HR 215 |
| ■ 16x8mm 5/8"x5/16" | HR 168 |

FRANÇAIS : Fers martelés sur les 4 faces.
 Livrés en longueurs de 3 mètres environ.

ENGLISH : Steel bars, with hammered sides.
 Available in lengths of ca. 3 meters. (9,85')

ESPAÑOL : Hierros martillados en las cuatro
 caras. Suministrados en longitud de 3 metros
 aproximadamente.

DEUTSCH : Eisen, vierseitig gehämmert.
 Lieferbar in Längen von ca. 3 Metern.

NEDERLANDS : Vierzijdig gehamerd ijzer.
 Leverbaar in lengten van ca. 3 meter.

RUSSE : Стальные прутки с чеканкой по
 краям. Поставляются в виде заготовок
 длиной по 3 метра.



| | |
|-------------------------|---------------|
| ■ 12 mm 1/2" | HC 120 |
| ■ 14 mm 9/16" | HC 140 |
| ■ 20 mm 3/4" | HC 200 |
| ■ 25 mm 1" | HC 250 |
| ■ 12x6mm 1/2"x1/4" | HC 126 |
| ■ 14x6mm 9/16"x1/4" | HC 146 |
| ■ 20x15mm 3/4"x9/16" | HC 215 |



FRANÇAIS : Tubes carrés et rectangulaires martelés sur les
 angles. Longueur : 3000 mm ou 6000 mm.

DEUTSCH : Vierkant und Rechteckröhre mit gehämmerten
 Kanten. Länge : 3000 mm oder 6000 mm.

ENGLISH : Square and rectangular box section, with
 hammered edges. Length : 3000 mm or 6000 mm.

NEDERLANDS : Vierkante en rechthoekige buis met
 gehamerde kanten, leverbaar in lengten van ca. 3 meter.

ESPAÑOL : Tubos cuadrados y rectangulares martillados en
 los vértices. Longitud : 3000 mm o 6000 mm.

RUSSE : Полый профиль квадратного или прямоугольного
 сечения с чеканкой по краям. Поставляется в виде
 заготовок длиной по 3/6 метра.

| | 3000mm | 6000mm |
|--|---------------|-----------------|
| ■ 30 x 20 x 2.0 mm 1 3/16 x 3/4" | HT 320 | HT 320-6 |
| ■ 40 x 20 x 2.0 mm 1 9/16 x 13/16" | HT 420 | HT 420-6 |
| ■ 40 x 30 x 2.5 mm 1 9/16 x 1 3/16" | HT 430 | HT 430-6 |
| ■ 50 x 30 x 2.5 mm 2 x 1 3/16" | HT 530 | HT 530-6 |
| ■ 60 x 40 x 2.5 mm 2 3/8 x 1 9/16" | HT 640 | HT 640-6 |
| ■ 80 x 40 x 3.0 mm 3 1/8 x 1 9/16" | HT 840 | HT 840-6 |

| | 3000mm | 6000mm |
|--|----------------|------------------|
| ■ 20 x 20 x 2.0 mm 13/16 x 13/16" | HT 200 | HT 200-6 |
| ■ 25 x 25 x 2.0 mm 1 x 1" | HT 250 | HT 250-6 |
| ■ 30 x 30 x 2.5 mm 1 13/16 x 1 13/16" | HT 300 | HT 300-6 |
| ■ 40 x 40 x 2.5 mm 1 9/16 x 1 9/16" | HT 400 | HT 400-6 |
| ■ 50 x 50 x 3.0 mm 2 x 2" | HT 500 | HT 500-6 |
| ■ 60 x 60 x 3.0 mm 2 3/8 x 2 3/8" | HT 600 | HT 600-6 |
| ■ 80 x 80 x 3.0 mm 3 1/8 x 3 1/8" | HT 800 | HT 800-6 |
| ■ 100 x 100 x 4.0 mm 4 x 4" | HT 1000 | HT 1000-6 |

FRANÇAIS : Profilés acier en barre.
DEUTSCH : Stangenmaterial.

ENGLISH : Steel bar stock.
ESPAÑOL : Barras de acero perfiladas.

RUSSE : Стальной профиль.

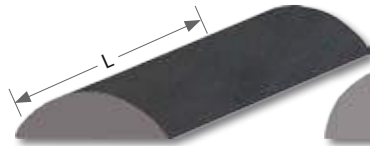

16 x 5mm
5/8 x 3/16"

L: 1200 mm
L: 47 1/4" **BCL 12**



20 x 10mm
3/4 x 3/8"

L: 3000 mm
L: 9,8' **BCL 23**



30 x 8mm
1 3/16 x 5/16"

L: 3000 mm
L: 9,8' **BCL 33**

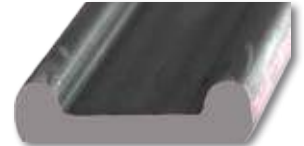

30 x 8mm
1 3/16 x 5/16"

L: 3000 mm
L: 9,8' **BCL 38**

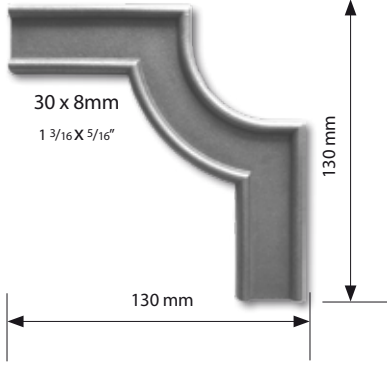

30 x 8mm
1 3/16 x 5/16"

130 mm

BCLA 38

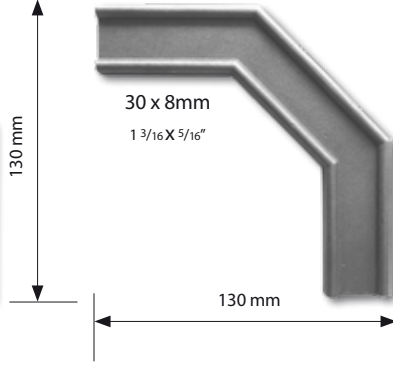

30 x 8mm
1 3/16 x 5/16"

130 mm

BCLB 38

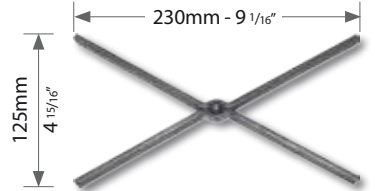

125mm
4 15/16"

14x6mm
9/16" x 1/4" **CK 232**

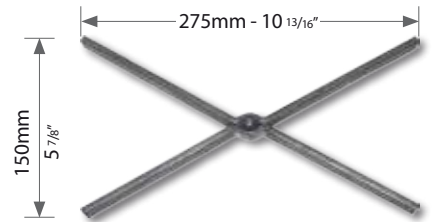

150mm
5 7/8"

16x8mm
5/8" x 5/16" **CK 274**

ELEMENTS DECORATIFS - ZIERELEMENTE - ORNAMENTS
ORNAMENTEN - ORNAMENTOS - ДЕКОРАТИВНЫЕ ЭЛЕМЕНТЫ

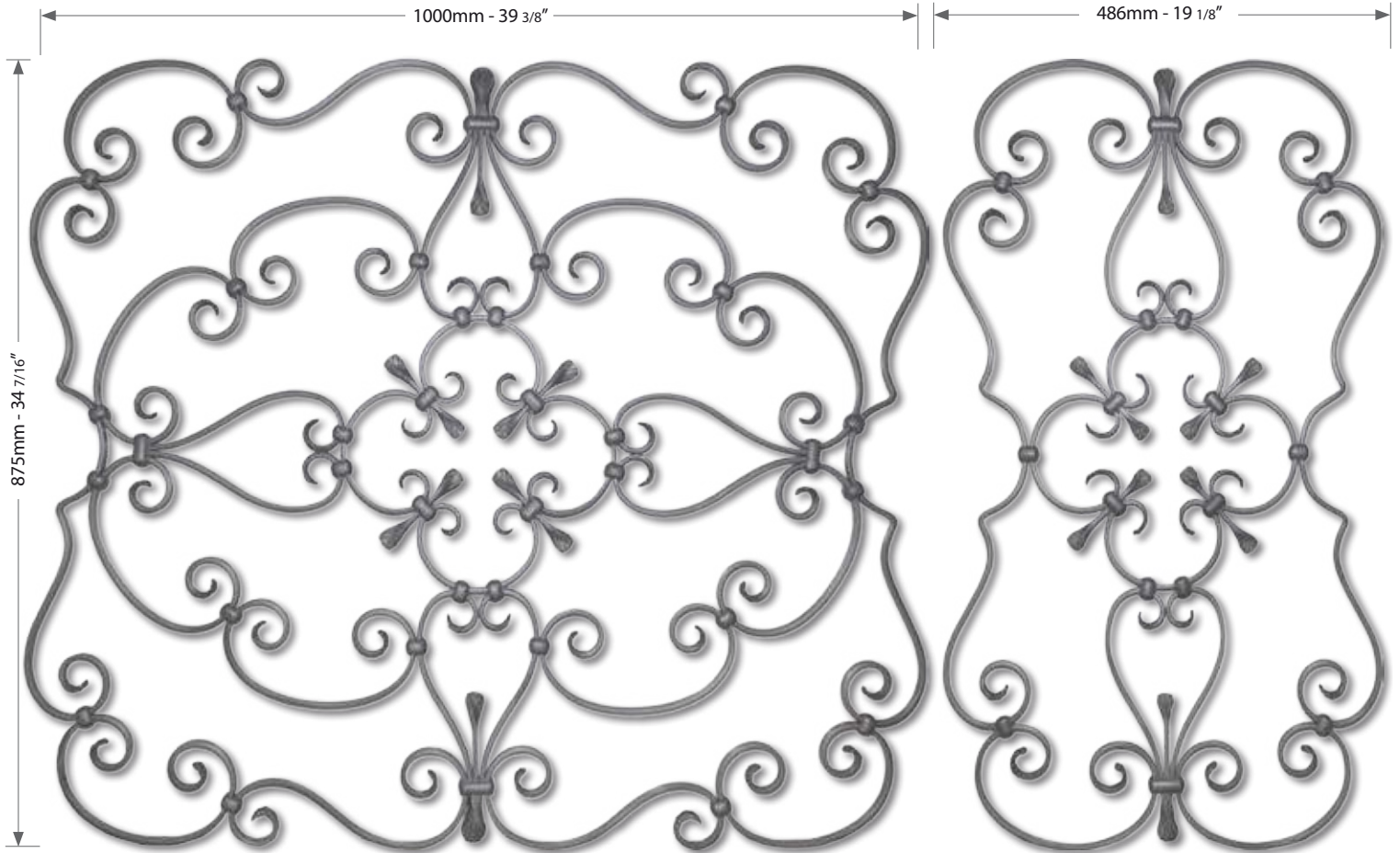

875mm - 34 7/16"

1000mm - 39 3/8"

486mm - 19 1/8"

14x6mm
9/16" x 1/4" **EL 1872**

12 x 6 mm
1/2 x 1/4" **EL 871**

14 x 6 mm
9/16 x 1/4" **EL 872**

FRANÇAIS : Partie centrale de balustre en fer forgé à chaud, à souder sur fer carré.

DEUTSCH : Einschweisstück aus Stahl, warm geschmiedet. Für Vierkant

ENGLISH : Baluster center made of hot forged steel; to weld onto square bars.

NEDERLANDS : Middenstuk voor baluster vervaardigd uit warm gesmeed ijzer, om tussen spijlen van vierkant te lassen.

ESPAÑOL : Elemento central de balaustre en hierro forjado en caliente para soldar a barra cuadrada

RUSSE : Стальная ковкая центральная вставка для стоек.

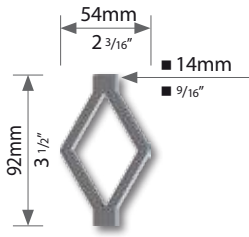

ESK 912

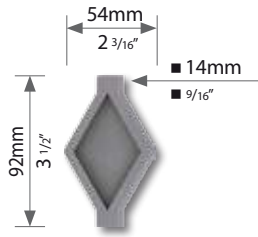

ESK 922

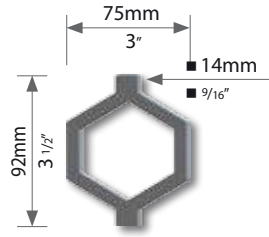

ESK 972

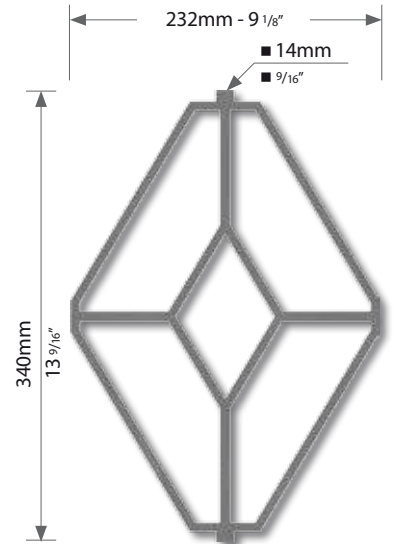

ESK 342
14x7mm
9/16"x1/4"

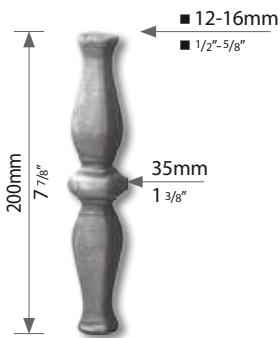

ESK 202



I 1201



I 1501

| | | |
|----------------------|---------------|---------------|
| 12x6mm 1/2"x1/4" | I 1201 | I 1501 |
| 14x6mm 9/16"x1/4" | I 1202 | I 1502 |
| 20x6mm 3/4"x1/4" | - | I 1503 |
| 16x8mm 5/8"x5/16" | - | I 1504 |



| | L = 245mm L = 9 5/8" | L = 300mm L = 11 13/16" | L = 350mm L = 13 3/4" | L = 410mm L = 16 1/8" |
|--------------------------|-------------------------|----------------------------|--------------------------|--------------------------|
| 12 x 6 mm 1/2 x 1/4" | EL 251 | EL 301 | EL 351 | - |
| 14 x 6 mm 9/16 x 1/4" | EL 252 | EL 302 | EL 352 | EL 412 |
| 20x6mm 3/4"x1/4" | - | - | EL 353 | EL 413 |
| 16x8mm 5/8"x5/16" | - | - | EL354 | EL 414 |

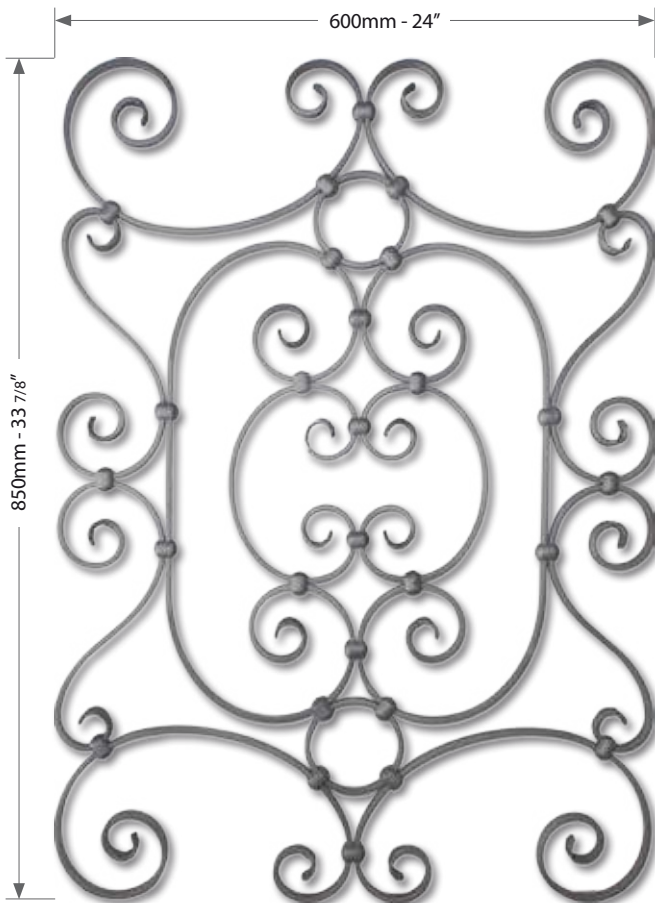

EL 852
14x6mm
9/16"x1/4"

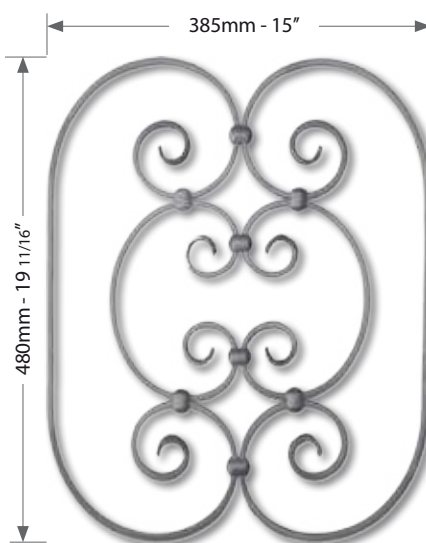

EL 482
14x6mm
9/16"x1/4"

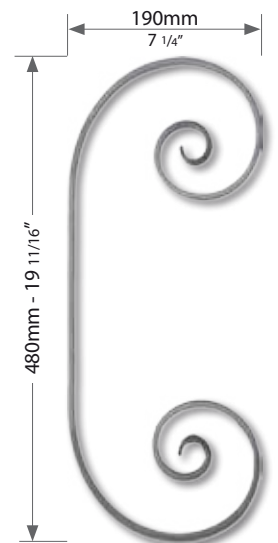

C 4802
14x6mm
9/16"x1/4"

FER

ELEMENTS DECORATIFS - ZIERELEMENTE - ORNAMENTS ORNAMENTEN - ORNAMENTOS - ДЕКОРАТИВНЫЕ ЭЛЕМЕНТЫ

FRANÇAIS : Eléments décoratifs préassemblés, à souder sur fer carré de 12 ou 14 mm. Les colliers ouverts à l'arrière sont prêts à être repliés.

DEUTSCH : Zierelemente zum Einschweißen. Die Bunde sind auf der Rückseite offen und zum Umbiegen vorgerichtet.

ENGLISH : Forged steel ornaments, to weld on to 12 or 14 mm (1/2 or 9/16") square pickets. The collars are open at the back ready to be closed.

NEDERLANDS : Sierelementen voor aan te lassen (spijlen 12 en 14 mm vierkant). Na het aanlassen de lusjes aan achterzijde ombuigen.

ESPAÑOL : Elementos decorativos premontados para soldar en hierro cuadrado de 12 ó 14 mm. Los collarines abiertos por detrás, están preparados para ser doblados.

RUSSE : Декоративные элементы, изготовленные из кованой стали, приваривают к квадратным прутьям 12 или 14 мм.

Соединительные звенья, открытые с тыльной стороны, могут быть замкнуты в любой момент.



| | | | |
|----------------|--------------------------|-----------------------|------|
| 12 mm 1/2" | 12 x 6 mm 1/2 x 1/4" | L=135mm L= 5 5/16" | D 71 |
| 14 mm 9/16" | 14 x 6 mm 9/16 x 1/4" | L=135mm L= 5 5/16" | D 72 |
| 16 mm 5/8" | 16 x 8 mm 5/8 x 5/16" | L=140mm L= 5 1/2" | D 74 |

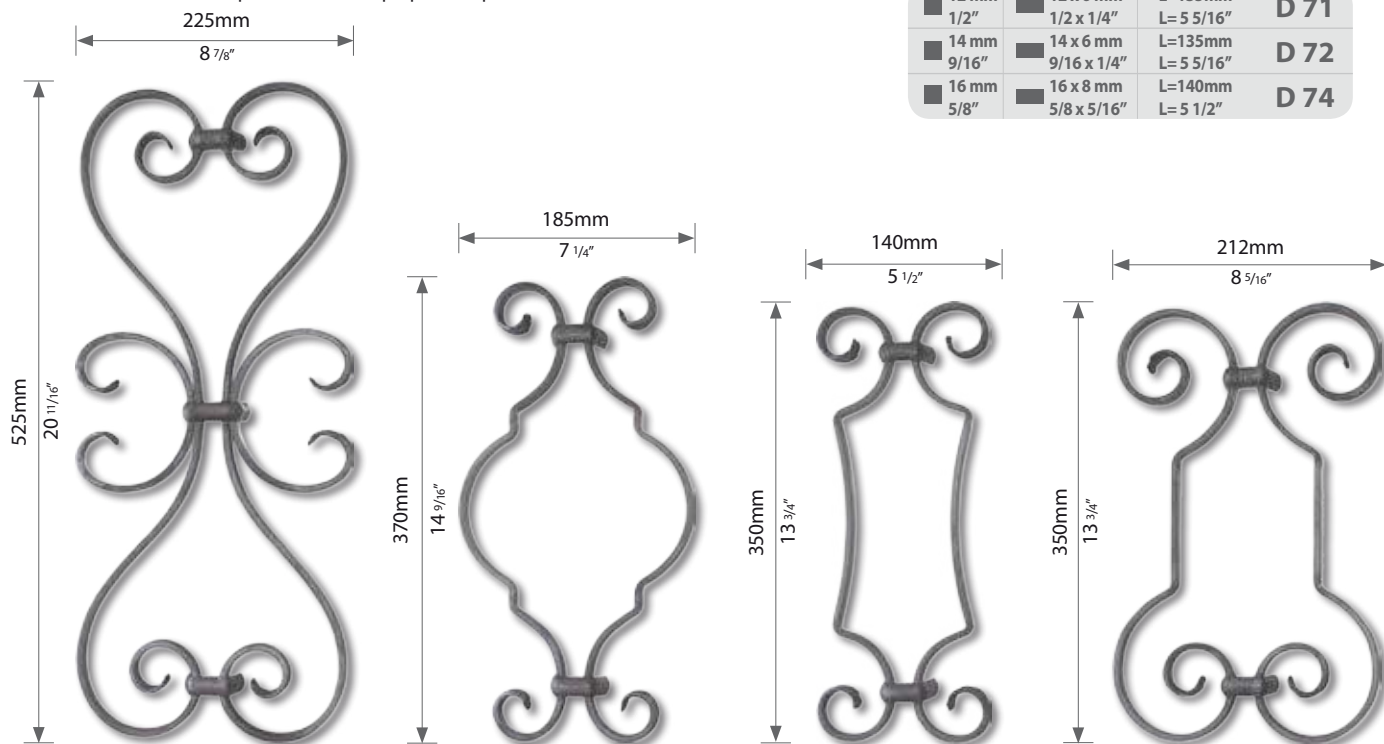

| | | | | | |
|----------------|--------------------------|-------|-------|-------|-------|
| 12 mm 1/2" | 12 x 6 mm 1/2 x 1/4" | D 141 | D 251 | D 161 | D 501 |
| 14 mm 9/16" | 14 x 6 mm 9/16 x 1/4" | D 142 | D 252 | D 162 | D 502 |

CERCLES ET OVALES - RINGE UND OVALE - RINGS AND OVALS RONDE EN OVALE RINGEN - AROS REDONDOS Y OVALADOS КРУГЛЫЕ И ОВАЛЬНЫЕ КОЛЬЦА

FRANÇAIS : Cercles et ovales formés à chaud. Non soudés.
DEUTSCH : Warmgeformte Ringe und ovale. ungeschweißt.

ENGLISH : Hotformed rings and ovals.
NEDERLANDS : Warm gesmede ronde en ovale ringen. open, niet gelast.
ESPAÑOL : Aros redondos y ovalados conformados en caliente. Sin soldar.
RUSSE : Горячекованные круглые и овальные кольца. Сделаны без сварки.

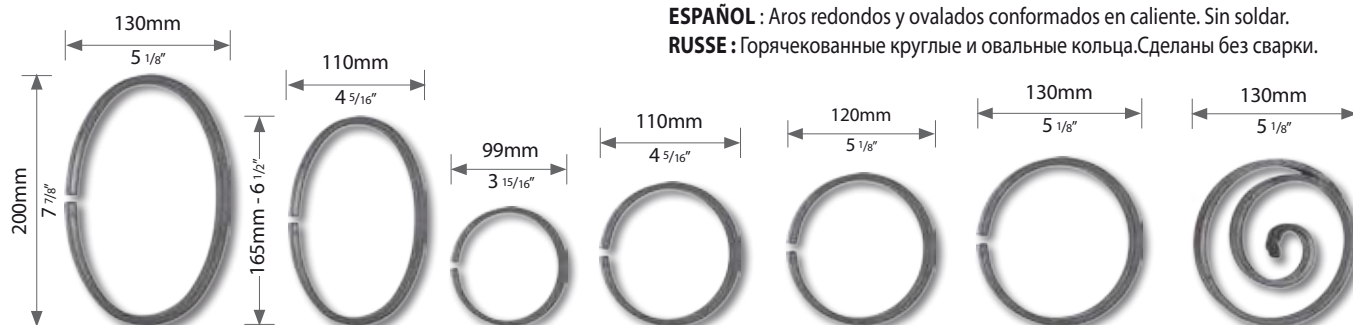

| | | | | | | | |
|----------------------|--------|--------|--------|--------|--------|--------|---------|
| 12x6mm 1/2"x1/4" | OV 131 | OV 111 | CR 101 | CR 111 | CR 121 | CR 131 | CRV 131 |
| 14x6mm 9/16"x1/4" | OV 132 | OV 112 | CR 102 | CR 112 | CR 122 | CR 132 | CRV 132 |
| 20x6mm 3/4"x1/4" | OV 133 | - | - | - | CR 123 | CR 133 | - |
| 16x8mm 5/8"x5/16" | OV 134 | OV 114 | - | CR 114 | - | CR 134 | - |

VOLUTES - SCHNÖRSEL - CURLS KRULEN - VOLUTAS ЗАВИТКИ

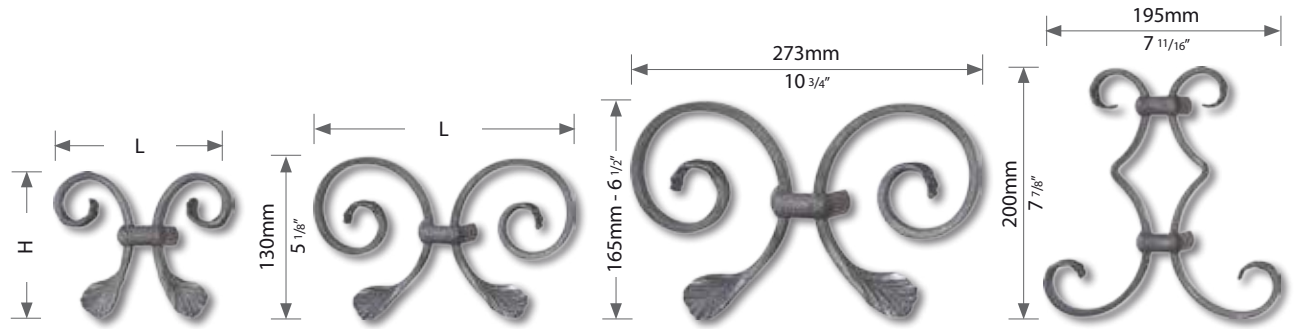

| | | | | | | | | |
|----------------|--------------------------|-------------|-----------------------|------------------------|--------------|----------------------|--------------|--------------|
| 12 mm 1/2" | 12 x 6 mm 1/2 x 1/4" | D 61 | L=130mm L= 5 1/8" | H=115mm H= 4 1/2" | D 101 | L=212mm L= 8 3/8" | - | D 271 |
| 14 mm 9/16" | 14 x 6 mm 9/16 x 1/4" | D 62 | L=130mm L= 5 1/8" | H=115mm H= 4 1/2" | D 102 | L=212mm L= 8 3/8" | D 132 | D 272 |
| 16 mm 5/8" | 16 x 8 mm 5/8 x 5/16" | D 64 | L=160mm L= 6 5/16" | H=125mm H= 4 15/16" | D 104 | L=215mm L= 8 1/2" | D 134 | - |



FRANÇAIS : Grandes volutes formées à chaud. Non soudées.

DEUTSCH : Große Schnörkel warm geschmiedet. An einem Stück.

ENGLISH : Large, hot forged scrolls. Forged in one piece.

NEDERLANDS : Grote warmgesmede krullen, gesmeed uit één stuk

ESPAÑOL : Volutas grandes conformadas en caliente. No soldadas.

RUSSE : Большие волюты, изготовленные с применением горячей формовки. Сделаны без сварки.

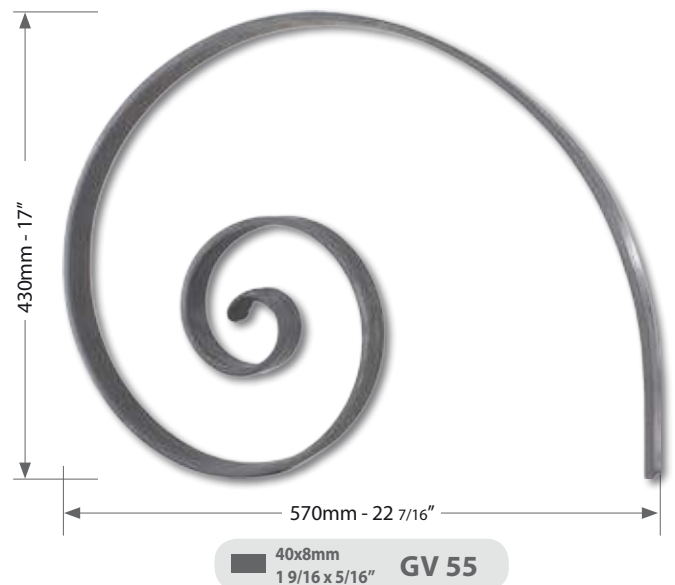

VOLUTES - SCHNÖRCEL - CURLS

FRANÇAIS : Toutes les volutes sont forgées et formées à chaud, avec une gravure sur les deux faces.

DEUTSCH : Alle Zierelemente sind warm geschmiedet und geformt. Die Prägung ist auf beiden Seiten.

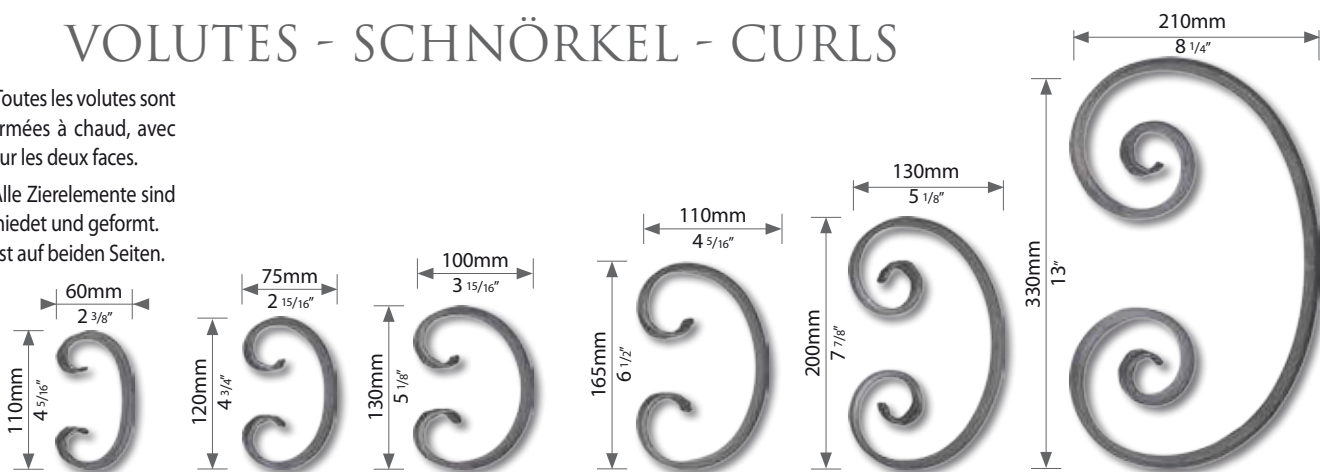

| | | | | | | |
|----------------------|--------|--------|--------|--------|--------|--------|
| 12x6mm 1/2"x1/4" | C 1101 | C 1201 | C 1301 | C 1601 | C 2001 | - |
| 14x6mm 9/16"x1/4" | C 1102 | C 1202 | C 1302 | C 1602 | C 2002 | C 3302 |
| 20x6mm 3/4"x1/4" | - | C 1203 | C 1303 | C 1603 | C 2003 | C 3303 |
| 16x8mm 5/8"x5/16" | C 1104 | C 1204 | C 1304 | C 1604 | C 2004 | C 3304 |

ENGLISH : All scrolls are hot forged, ends stamped on both sides.

NEDERLANDS : Alle krullen zijn tweezijdig warm uitgesmeed en gevormd.

ESPAÑOL : Todas las volutas están forjadas y conformadas en caliente con ambas caras grabadas.

RUSSE : Все завитки (спирали) выкованы горячим способом, концы с обеих сторон штампованы

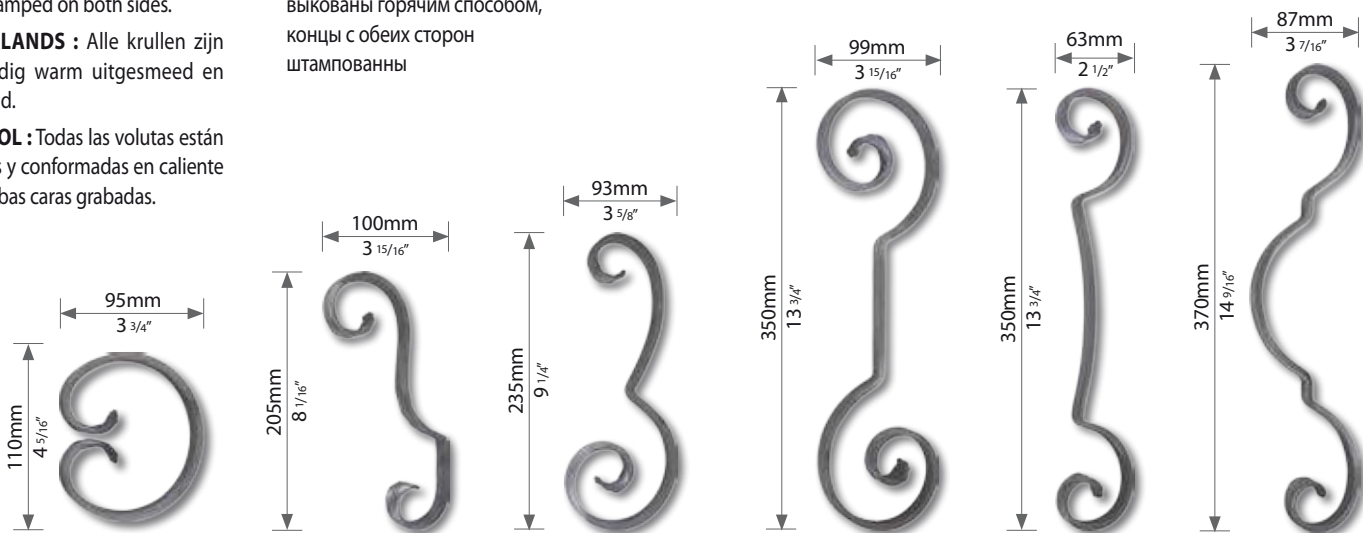

| | | | | | | |
|----------------------|--------|--------|--------|--------|--------|--------|
| 12x6mm 1/2"x1/4" | R 1101 | L 2001 | L 2301 | L 3501 | L 3601 | L 3701 |
| 14x6mm 9/16"x1/4" | R 1102 | L 2002 | L 2302 | L 3502 | L 3602 | L 3702 |

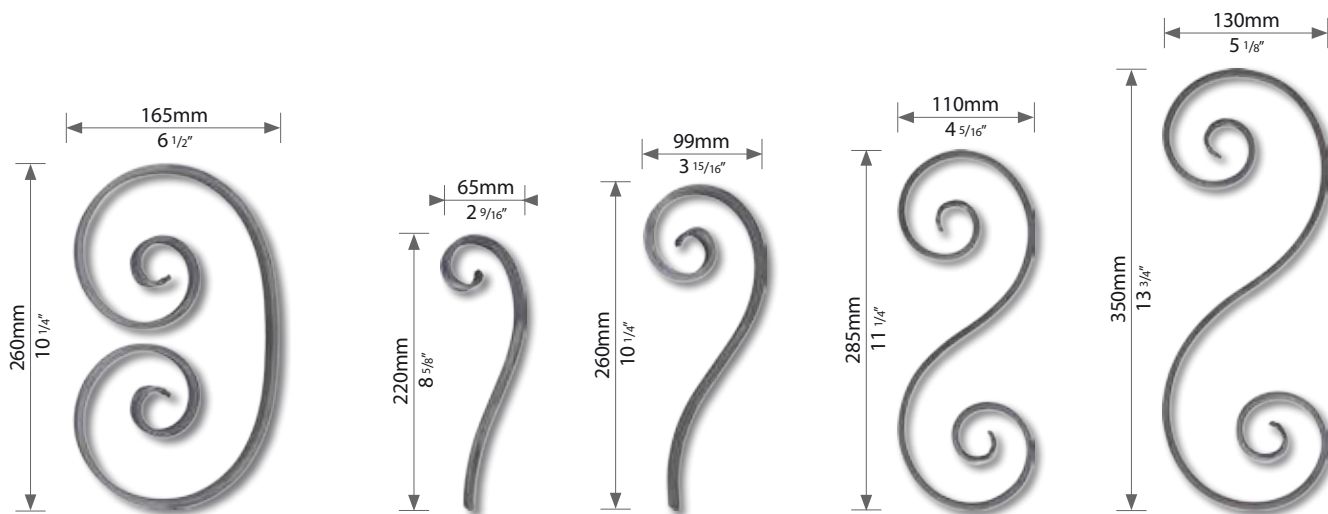

| | | | | | |
|----------------------|--------|--------|--------|--------|--------|
| 12x6mm 1/2"x1/4" | - | J 2201 | J 2601 | S 2801 | S 3501 |
| 14x6mm 9/16"x1/4" | R 2602 | J 2202 | J 2602 | S 2802 | S 3502 |
| 20x6mm 3/4"x1/4" | R 2603 | J 2203 | J 2603 | S 2803 | S 3503 |
| 16x8mm 5/8"x5/16" | R 2604 | - | - | S 2804 | S 3504 |

KRULEN - VOLUTAS - ЗАВИТКИ

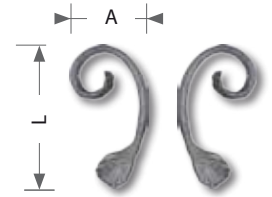
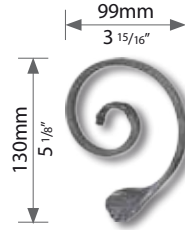
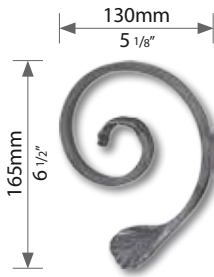

| | | | | | | |
|----------------------|----------|----------|----------|----------|---------------------------------------|-------------------|
| 12x6mm 1/2"x1/4" | - | - | J 1001 L | J 1001 R | A=60mm - 2 3/8" L=115mm - 4 1/2" | J 0601 L J 0601 R |
| 14x6mm 9/16"x1/4" | J 1302 L | J 1302 R | J 1002 L | J 1002 R | A=60mm - 2 3/8" L=115mm - 4 1/2" | J 0602 L J 0602 R |
| 20x6mm 3/4"x1/4" | J 1303 L | J 1303 R | - | - | - | - |
| 16x8mm 5/8"x5/16" | J 1304 L | J 1304 R | J 1004 L | J 1004 R | A=70mm - 2 3/4" L=125mm - 4 15/16" | J 0604 L J 0604 R |

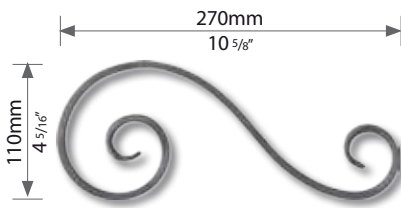

| | | |
|--------|----------------------|--------|
| S 2701 | 12x6mm 1/2"x1/4" | - |
| S 2702 | 14x6mm 9/16"x1/4" | S 4502 |
| S 2703 | 20x6mm 3/4"x1/4" | S 4503 |
| S 2704 | 16x8mm 5/8"x5/16" | S 4504 |

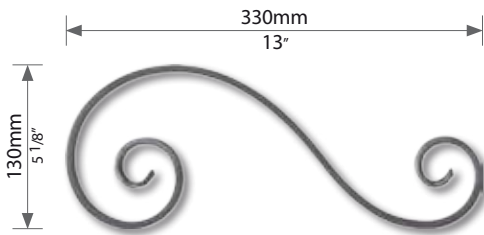
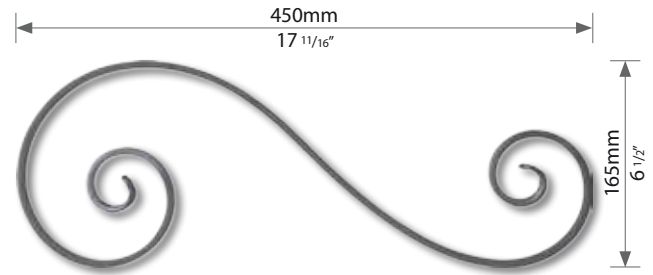

| | | |
|--------|----------------------|--------|
| S 3301 | 12x6mm 1/2"x1/4" | - |
| S 3302 | 14x6mm 9/16"x1/4" | S 4102 |
| S 3303 | 20x6mm 3/4"x1/4" | S 4103 |
| S 3304 | 16x8mm 5/8"x5/16" | S 4104 |

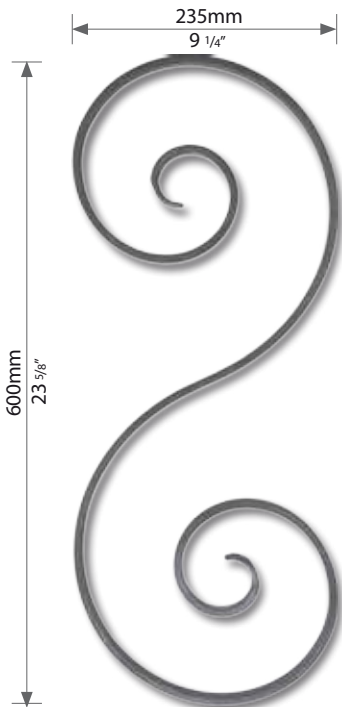
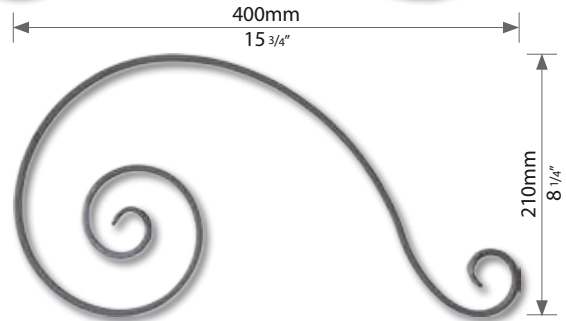

| | |
|----------------------|--------|
| 14x6mm 9/16"x1/4" | S 6502 |
| 20x6mm 3/4"x1/4" | S 6503 |
| 16x8mm 5/8"x5/16" | S 6504 |

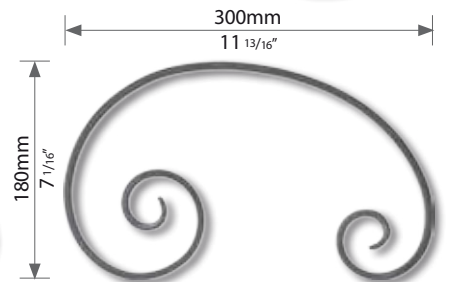
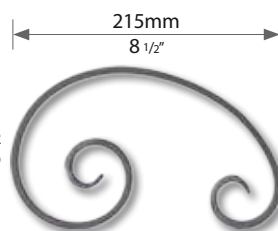
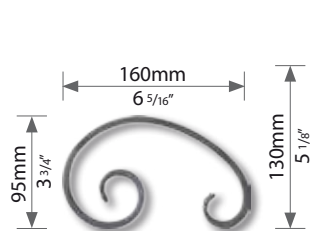
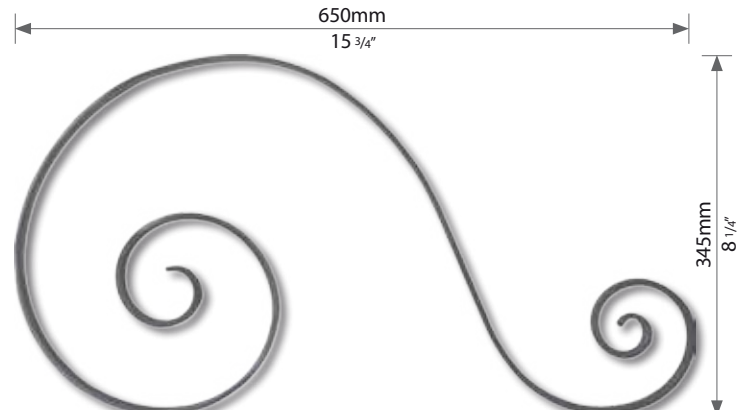

| | | | | |
|--------|----------------------|--------|--------|--------|
| - | 12x6mm 1/2"x1/4" | L 1301 | - | - |
| S 6002 | 14x6mm 9/16"x1/4" | L 1302 | L 2102 | L 3002 |
| S 6003 | 20x6mm 3/4"x1/4" | - | L 2103 | L 3003 |
| S 6004 | 16x8mm 5/8"x5/16" | - | L 2104 | L 3004 |

FER

CHAPEAUX DE GENDARME - PREFORMED TUBES
 SCHWEIFBÖGEN- ARCOS PARA PORTAL - ИЗОГНУТЫЕ ПРЯМОУГОЛЬНЫЕ

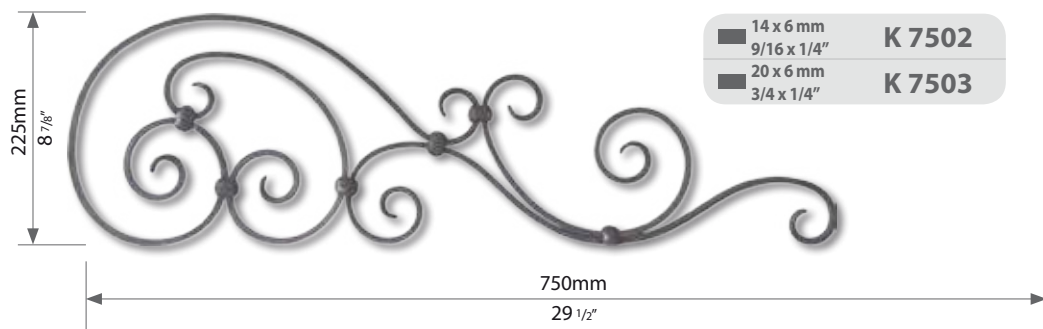

| | | |
|------------|------------|--------------|
| B: 30 mm | L: 55 mm | AD 30 |
| B: 1 3/16" | L: 2 1/8" | |
| B: 40 mm | L: 65 mm | AD 40 |
| B: 1 9/16" | L: 2 9/16" | |

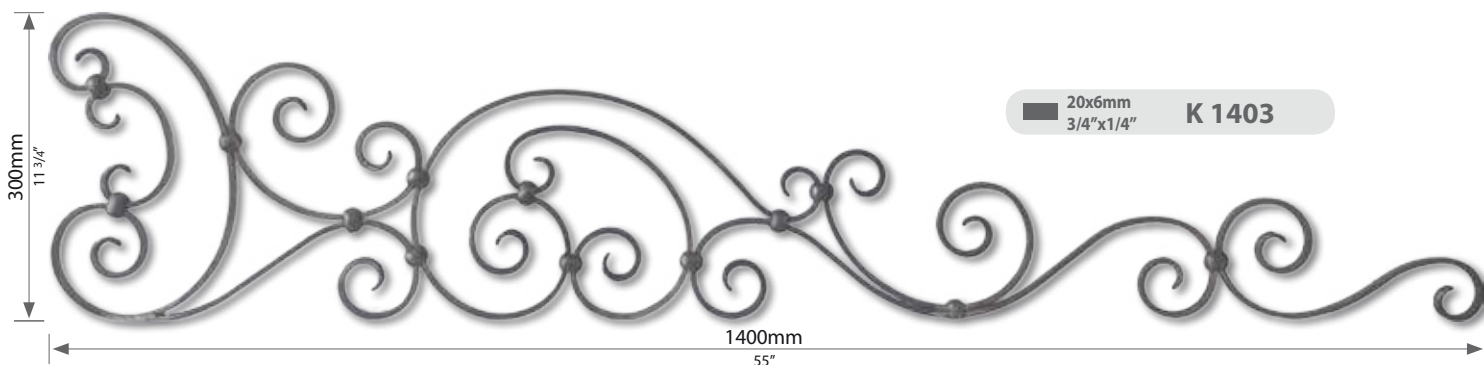
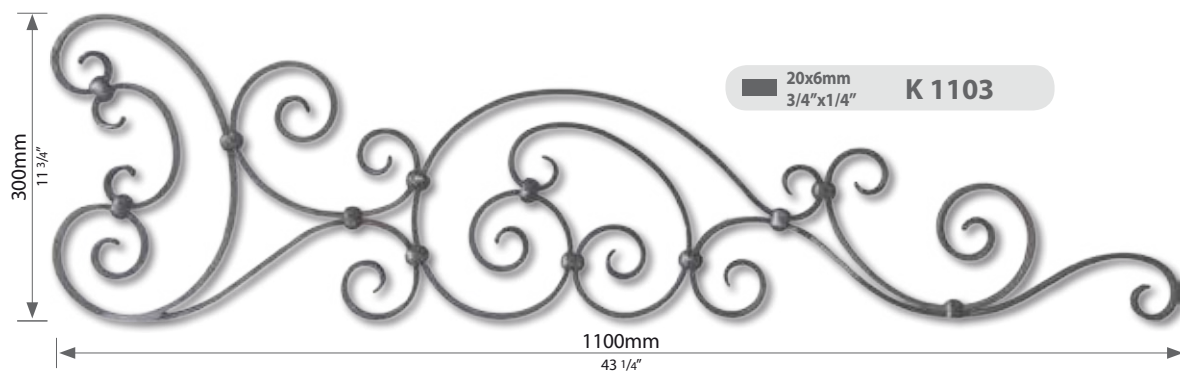
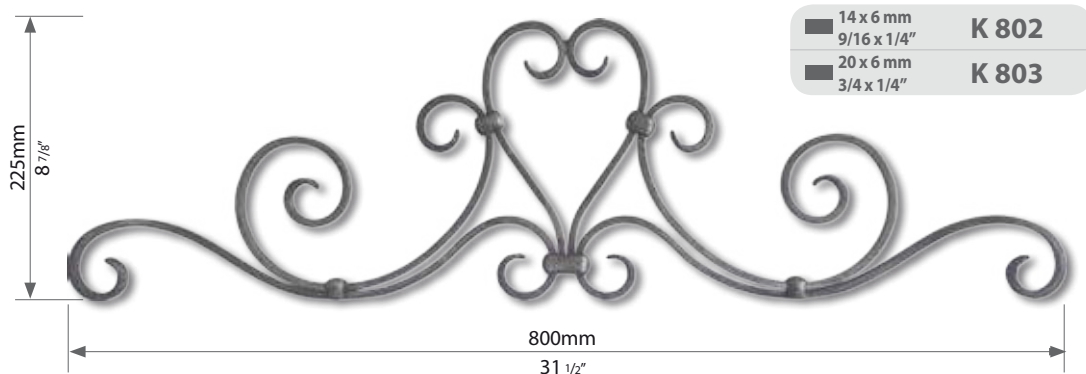

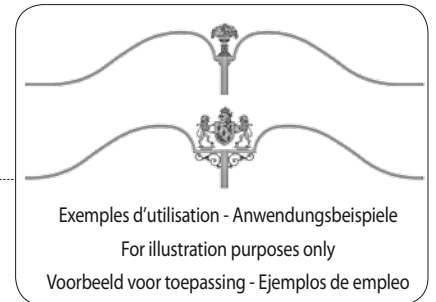
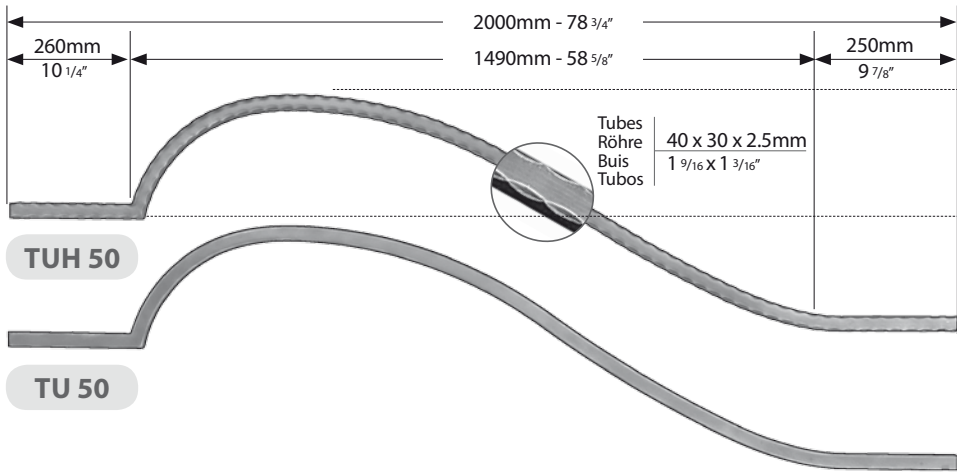
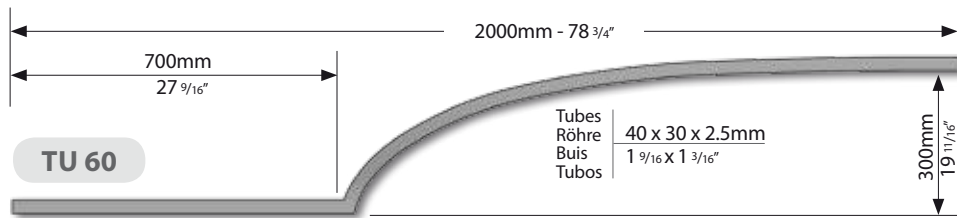

FRANÇAIS : Livré par paire.
DEUTSCH : Paarweise geliefert.
ENGLISH : Supplied in pairs.
NEDERLANDS : Leverbaar per paar.
ESPAÑOL : Se suministra por parejas.
RUSSE : Поставляются парами.

| | | |
|------------------------|---------------------------|--------------|
| L: 3500 mm L: 11,5" | H: 200 mm H: 7 7/8" | TU 20 |
| L: 3500 mm L: 11,5" | H: 300 mm H: 11 13/16" | TU 30 |
| L: 3500 mm L: 11,5" | H: 400 mm H: 15 3/4" | TU 40 |

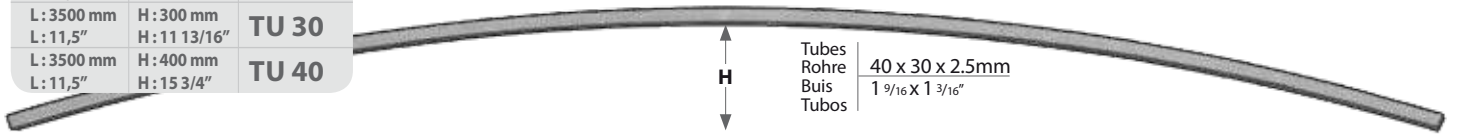

| | | |
|------------------------|---------------------------|---------------|
| L: 3500 mm L: 11,5" | H: 200 mm H: 7 7/8" | TUH 20 |
| L: 3500 mm L: 11,5" | H: 300 mm H: 11 13/16" | TUH 30 |
| L: 3500 mm L: 11,5" | H: 400 mm H: 15 3/4" | TUH 40 |

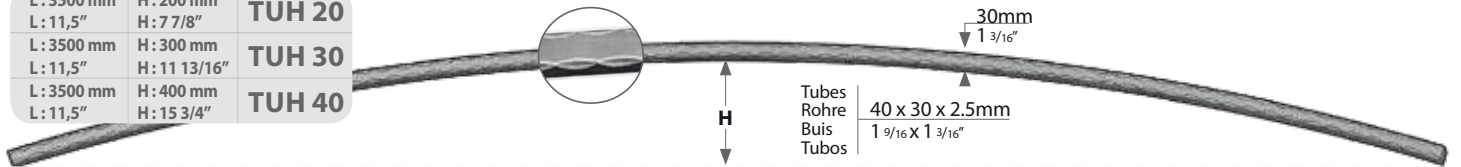

| | | |
|------------------------|---------------------------|--------------|
| L: 3500 mm L: 11,5" | H: 300 mm H: 11 13/16" | TU 33 |
| L: 3500 mm L: 11,5" | H: 400 mm H: 15 3/4" | TU 43 |
| L: 4000 mm L: 13,1" | H: 400 mm H: 15 3/4" | TU 44 |

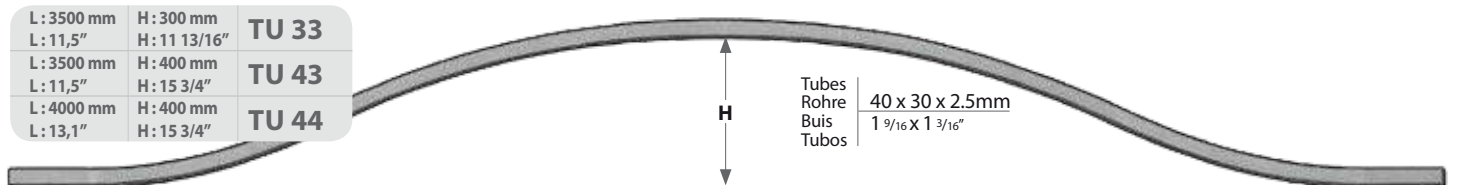

| | | |
|------------------------|---------------------------|---------------|
| L: 3500 mm L: 11,5" | H: 300 mm H: 11 13/16" | TUH 33 |
| L: 3500 mm L: 11,5" | H: 400 mm H: 15 3/4" | TUH 43 |
| L: 4000 mm L: 13,1" | H: 400 mm H: 15 3/4" | TUH 44 |

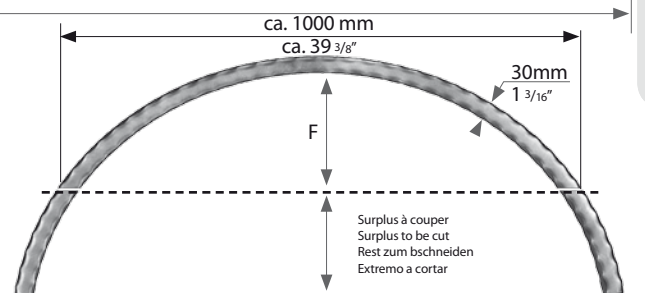
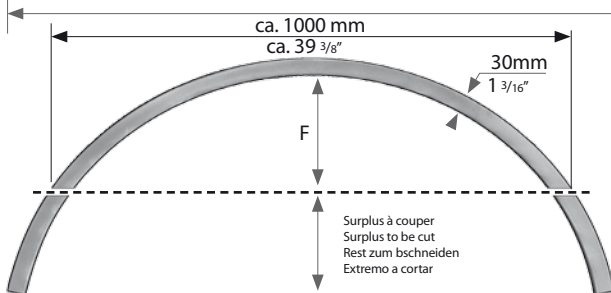
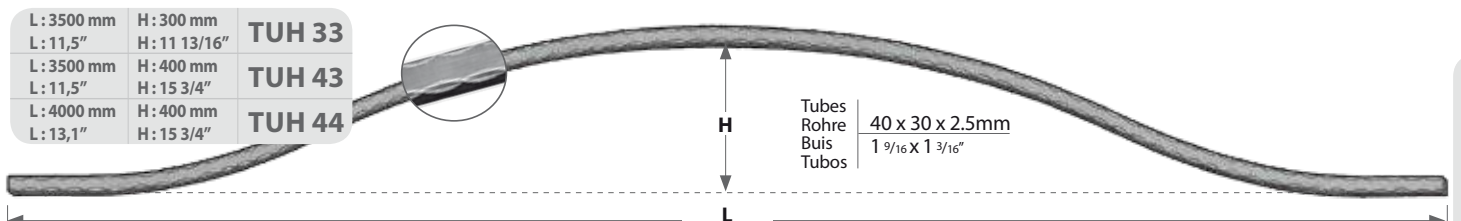

| | |
|---------------------------|--------------|
| F: 200 mm F: 7 7/8" | TU 12 |
| F: 300 mm F: 11 13/16" | TU 13 |
| F: 400 mm F: 15 3/4" | TU 14 |

FRANÇAIS : Hauts de portail cintrés en tube rectangulaire 40x30 mm. Lisses ou martelés sur angles.
DEUTSCH : Stichbogen und Schweißbogen für Tore aus Rechteckrohr 40x30 mm. Glatt oder Kantengehämmert.
ENGLISH : Preformed rectangular tubes 40x30 mm (1 9/16" x 1 3/16"). Smooth or with hammered edges.

NEDERLANDS : Gebogen hekwerkkokers 40x30 mm. In gladde of gehamerde uitvoering leverbaar.
ESPAÑOL : Pieza superior de portal arqueado en tubo rectangular de 40x30 mm. Lisas o martilleadas en las esquinas.
RUSSE : Изогнутые (дуги) прямоугольные трубы сечением 40 x 30 мм. Гладкие или с чеканкой по краям.

| | |
|---------------------------|---------------|
| F: 200 mm F: 7 7/8" | TUH 12 |
| F: 300 mm F: 11 13/16" | TUH 13 |
| F: 400 mm F: 15 3/4" | TUH 14 |

SUR MESURE - MADE TO MEASURE - NACH MAß

Veillez préciser la section du tube, lisse ou martelé, les cotes B, F et L.

Please specify the tube's section, whether smooth or hammered, as well as the dimensions B, F and L.

Bitte angeben, ob glatt oder gehämmert, sowie Maße B, F und L.

Indique la seccion del tubo, si es liso o matillado y las cotas B, F y L.

Пожалуйста, укажите сечение трубы, гладкое или кованое, а также размеры B, F и L.

CINTRES - ARC DESIGN - STICHBÖGEN - CURVAS ИЗОГНУТЫЕ ПРЯМОУГОЛЬНЫЕ

| | |
|--|---|
| Tubes lisses ou martelés sur angles | LONGUEUR L : MINI 1000 mm - MAXI 5000 mm. |
| Smooth tubes or tubes with hammered edges | LENGTH L : MINI 1000 mm, MAXI 5000 mm. |
| Glatte oder kantengehämmerte Rohre | LÄNGE L : MINI 1000 mm, MAXI 5000 mm. |
| Tubos lisos o con las esquinas martilladas | LONGITUD L : MINIMO 1000 mm - MAXIMO 5000 mm. |
| Гладкие трубки или трубки с забитыми краями | ДЛИНА L : МИНУТА 1000 mm - МАКСИМУМ 5000 mm. |

| | | |
|------------------------------|------------------|------------------|
| Sections disponibles | 20 x 20 x 2,0 mm | 30 x 20 x 2,0 mm |
| Available sizes | 30 x 30 x 2,5 mm | 40 x 20 x 2,0 mm |
| Rohre Abmessungen | 40 x 40 x 2,5 mm | 40 x 30 x 2,5 mm |
| Secciones disponibles | 50 x 50 x 3,0 mm | 50 x 30 x 2,5 mm |
| раздел доступен | 60 x 60 x 3,0 mm | 60 x 40 x 2,5 mm |

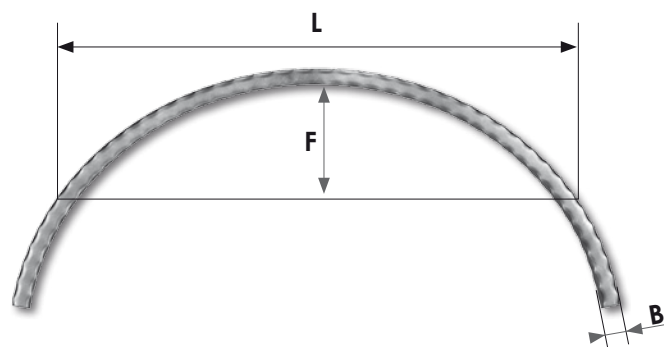
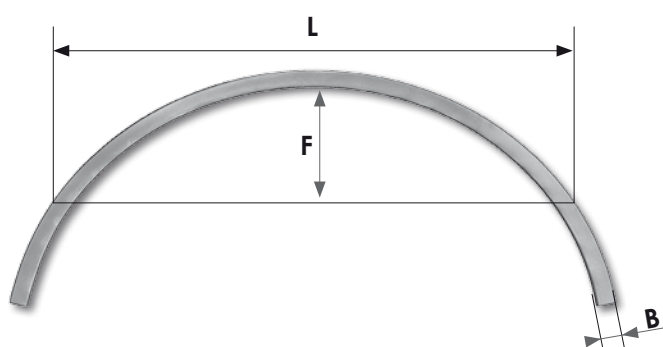

A MEDIDA - СДЕЛАНО ДЛЯ ИЗМЕРЕНИЯ

Veillez préciser la section du tube, lisse ou martelé, les cotes B, F et L.

Please specify the tube's section, whether smooth or hammered, as well as the dimensions B, F and L.

Bitte angeben, ob glatt oder gehämmert, sowie Maße B, F und L.

Indique la seccion del tubo, si es liso o matilleado y las cotas B, F y L.

Пожалуйста, укажите сечение трубы, гладкое или кованое, а также размеры B, F и L.

CHAPEAUX DE GENDARME - PREFORMED TUBES - SCHWEIFBÖGEN ARCOS PARA PORTAL - ИЗОГНУТЫЕ ПРЯМОУГОЛЬНЫЕ

| | |
|--|---|
| Tubes lisses ou martelés sur angles | LONGUEUR L : MINI 2500 mm - MAXI 5000 mm. |
| Smooth tubes or tubes with hammered edges | LENGTH L : MINI 2500 mm, MAXI 5000 mm. |
| Glatte oder kantengehämmerte Rohre | LÄNGE L : MINI 2500 mm, MAXI 5000 mm. |
| Tubos lisos o con las esquinas martilleadas | LONGITUD L : MINIMO 2500 mm - MAXIMO 5000 mm. |
| Гладкие трубки или трубки с забитыми краями | ДЛИНА L : МИНУТА 2500 mm - МАКСИМУМ 5000 mm. |

| | | |
|------------------------------|------------------|------------------|
| Sections disponibles | 20 x 20 x 2,0 mm | 30 x 20 x 2,0 mm |
| Available sizes | 30 x 30 x 2,5 mm | 40 x 20 x 2,0 mm |
| Rohre Abmessungen | 40 x 40 x 2,5 mm | 40 x 30 x 2,5 mm |
| Secciones disponibles | 50 x 50 x 3,0 mm | 50 x 30 x 2,5 mm |
| раздел доступен | 60 x 60 x 3,0 mm | 60 x 40 x 2,5 mm |

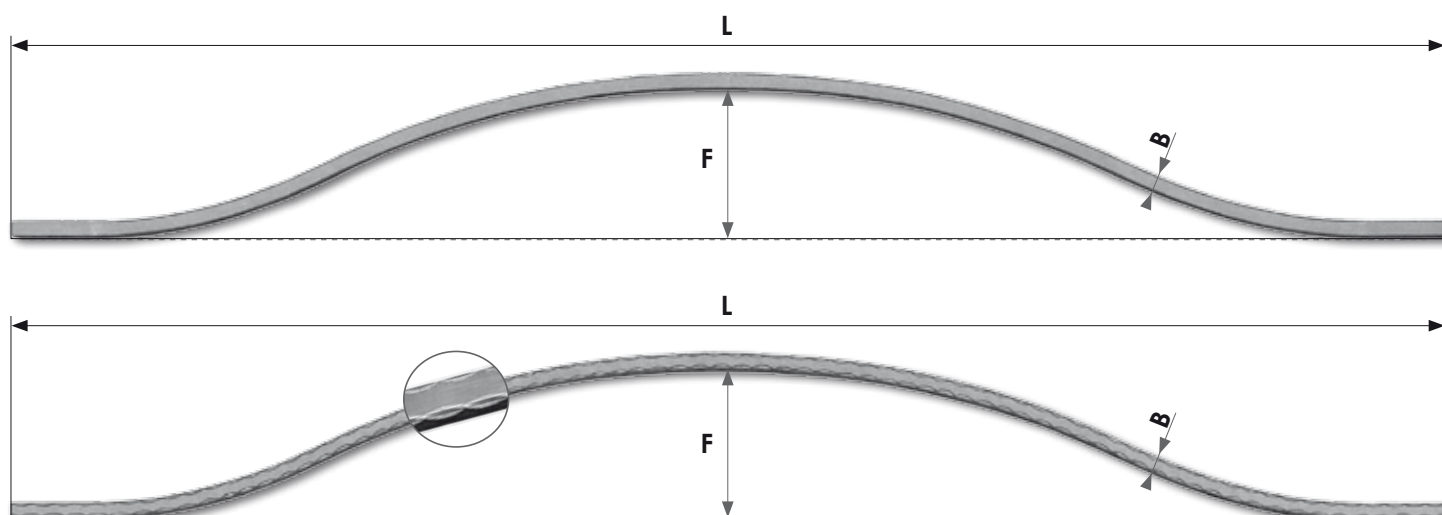

MANCHONS - ZIERHÜLSEN - SLEEVES

SIERHULZEN - MACOLLAS - СОЕДИНИТЕЛЬНЫЕ ЭЛЕМЕНТЫ

FRANÇAIS : Manchons décoratifs, en acier, tournés. Equipés d'une vis de blocage. **GALVANISABLES.**

DEUTSCH : Zierhülsen aus Stahl, abgedreht. Ausgerüstet mit einer Blockierschraube. **FEUERVERZINKBAR.**

ENGLISH : Decorative steel sleeves. Supplied with set screw. **SUITABLE FOR HOT DIP GALVANIZING.**

NEDERLANDS : Stalen sierhulzen, gedraaid. Voorzien van een blokkeerschroefje om de sierhuls vast te zetten. Materiaal St. 37, **VERZINKBAAR.**

ESPAÑOL : Macollas decorativas en acero, torneadas. Equipadas con tornillo de fijación. **GALVANIZABLES.**

RUSSE : Декоративные стальные соединительные элементы. Поставляются с крепёжными винтами. **Пригодны для цинкования.**

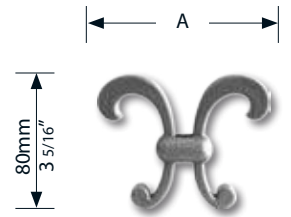

| | | |
|------------------|---------------------------|---------------|
| ● 14 mm 9/16" | A = 101 mm A = 4" | D 82 R |
| ● 16 mm 5/8" | A = 103 mm A = 4 1/16" | D 83 R |

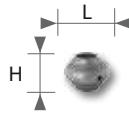

| | | | |
|--------------------|------------------------|------------------------|---------------|
| ● 14 mm 9/16" | L: 33 mm L: 1 5/16" | H: 24 mm H: 15/16" | EG 114 |
| ● 16 mm 5/8" | L: 37 mm L: 1 7/16" | H: 27 mm H: 1 1/16" | EG 116 |
| ● 18 mm 1 1/16" | L: 41 mm L: 1 5/8" | H: 30 mm H: 1 3/16" | EG 118 |

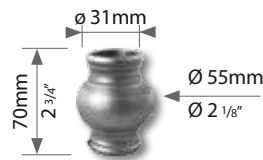

● 30 mm
1 3/16" **EG 741**

Boules plates tournées, avec trou 5,5 mm.
Gedrehte Flachkugeln, mit 5,5 mm Loch.
Turned flattened balls, with 5.5 (0.21") hole.
Gedraaide halfronde ringen, met gat Ø 5,5 mm.
Bolas planas torneadas.
Точёные сплюснутые шарики с отверстием Ø 5,5 мм.

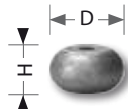

| | | |
|----------------------|------------------------|--------------|
| H: 13 mm H: 1/2" | D: 21 mm D: 1 3/16" | OL 13 |
| H: 15 mm H: 9/16" | D: 27 mm D: 1 1/16" | OL 15 |

Sachets de 10 pièces / 10 Stück pro Pack
10 pees per bag / Eenheidsverpakking 10 st
Disponibile en bolsas de 10 unidades
Сумки по 10 штук

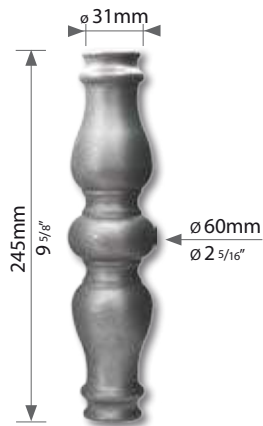

● 30 mm
1 3/16" **EG 743**

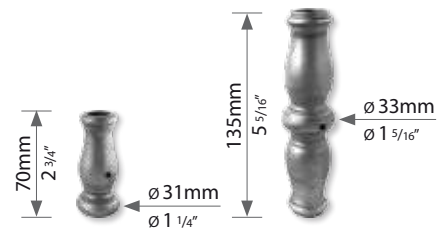

● 14 mm
9/16" **EG 514** **EG 714**

Bagues en fer, tournées. À souder.
Gedrehte Einschweißteile.
Turned steel ornaments. Fully weldable.
Gedraaide sierringen.
Anillos de hierro torneados para soldar.
Точёное стальное кольцо. Можно приваривать.

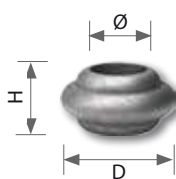

| | | | |
|-------------------------|-----------------------|------------------------|--------------|
| Ø: 14,5 mm Ø: 9/16" | H: 23 mm H: 7/8" | D: 34 mm D: 1 5/16" | EG 14 |
| Ø: 17 mm Ø: 11/16" | H: 23 mm H: 7/8" | D: 38 mm D: 1 1/2" | EG 16 |
| Ø: 18,5 mm Ø: 3/4" | H: 23 mm H: 7/8" | D: 40 mm D: 1 9/16" | EG 18 |
| Ø: 20,5 mm Ø: 13/16" | H: 23 mm H: 7/8" | D: 41 mm D: 1 5/8" | EG 20 |
| Ø: 31 mm Ø: 1 3/16" | H: 35 mm H: 1 3/8" | D: 63 mm D: 2 1/2" | EG 30 |

Manchons en acier moulé.
Zierhülsen aus Schmiedeguß.
Decorative steel sleeves.
Sierhulzen van gietstaal.
Macollas en acero moldeado.
Литые стальные муфты.

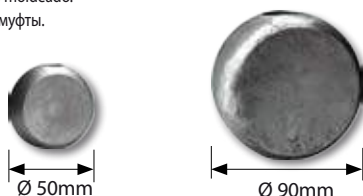

● 12 mm
1/2" **EG 551** ● 30 mm
1 3/16" **EG 553**

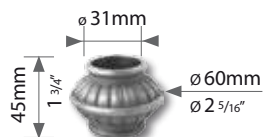

● 30 mm
1 3/16" **EG 831**

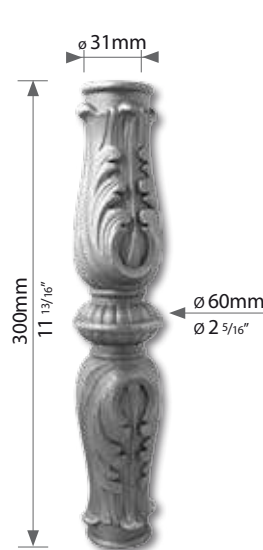

● 30 mm
1 3/16" **EG 833**

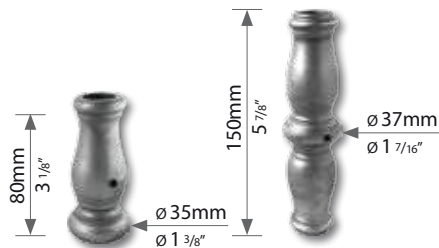

● 16 mm
5/8" **EG 516** **EG 716**

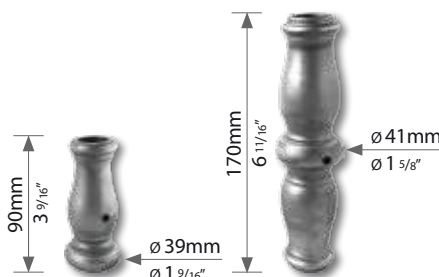

● 18 mm
1 1/16" **EG 518** **EG 718**

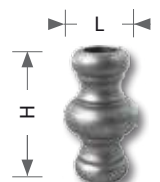

| | | | |
|--------------------|-------------------------|-------------------------|---------------|
| ● 14 mm 9/16" | L: 36 mm L: 1 7/16" | H: 65 mm H: 2 9/16" | EG 614 |
| ● 16 mm 5/8" | L: 38 mm L: 1 1/2" | H: 69 mm H: 2 11/16" | EG 616 |
| ● 18 mm 1 1/16" | L: 43 mm L: 1 11/16" | H: 74 mm H: 2 15/16" | EG 618 |

MANCHONS - ZIERHÜLSEN - SLEEVES - SIERHULZEN MACOLLAS - СОЕДИНИТЕЛЬНЫЕ ЭЛЕМЕНТЫ

FRANÇAIS : Manchons décoratifs. Ils sont équipés d'une vis de blocage M 3 permettant un montage facile et rapide.

DEUTSCH : Zierhülsen, ausgerüstet mit einer M 3 Blockierschraube für einfache und rasche Montage.

ENGLISH : Decorative sleeves equipped with an M 3 locking screw to allow a fast and easy mounting.

NEDERLANDS : Sierhulzen voorzien van een M 3 blokkeringschroefje voor eenvoudige en snelle montage.

ESPAÑOL : Macolla decorativa equipada con tornillo de bloqueo M 3 para un montaje impecable y rápido.

RUSSE : Отделочная втулка с крепежным болтом М 3, позволяет быстрый и легкий монтаж.



AISI 304 (V2A) **WM 34**
AISI 316 (V4A) **WM 934**

AISI 304 (V2A) **WM 124**
AISI 316 (V4A) **WM 9124**

AISI 304 (V2A) **WM 54**
AISI 316 (V4A) **WM 954**

MANCHONS - ZIERHÜLSEN - SLEEVES - SIERHULZEN MACOLLAS - СОЕДИНИТЕЛЬНЫЕ ЭЛЕМЕНТЫ

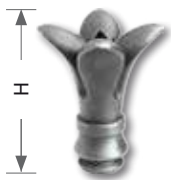

FRANÇAIS : Manchons décoratifs pour fers carrés en acier moulé, **GALVANISABLES**. Equipés d'une vis de blocage.

DEUTSCH : Zierhülsen für Vierkanteisen aus Schmiedeguß, **FEUERVERZINKBAR**. Ausgerüstet mit einer Blockierschraube.

ENGLISH : Decorative steel sleeves for square bars, **SUITABLE FOR GALVANIZING**. Supplied with set screw.

NEDERLANDS : Sierhulzen voor vierkante balusters, uit smeedbaar gietijzer, **VERZINKBAAR** en voorzien van blokkeerschroefje.

ESPAÑOL : Macollas decorativas para cuadrado de hierro; en acero moldeado, **GALVANIZABLE**. Equipado con tornillo de fijación.

RUSSE : Декоративные стальные соединительные элементы для квадратных стоек. **ПРИГОДНЫ ДЛЯ ЦИНКОВАНИЯ**. Поставляются с крепежными винтами

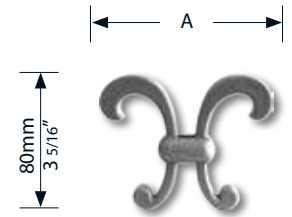

| | | |
|-----------------|--------------------------|--------------|
| 14 mm 9/16" | H : 83mm H : 3 3/8" | LAD14 |
| 16 mm 5/8" | H : 95mm H : 3 3/4" | LAD16 |
| 18 mm 11/16" | H : 106mm H : 4 3/16" | LAD18 |
| 20 mm 13/16" | H : 120mm H : 4 3/4" | LAD20 |

| | | |
|----------------|---------------------------|---------------|
| 12 mm 1/2" | A = 104 mm A = 4 1/8" | D 81 K |
| 14 mm 9/16" | A = 106 mm A = 4 3/16" | D 82 K |

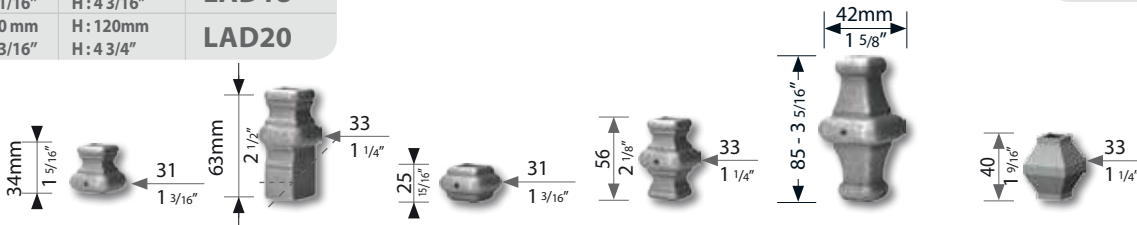

| | | | | | |
|----------------|---------------|---------------|---------------|---------------|-----------------------------|
| 12 mm 1/2" | EGK 31 | - | EGK 12 | EGK 51 | - |
| 14 mm 9/16" | EGK 32 | EGK 33 | EGK 14 | EGK 52 | EGK 82 EGK 42 |

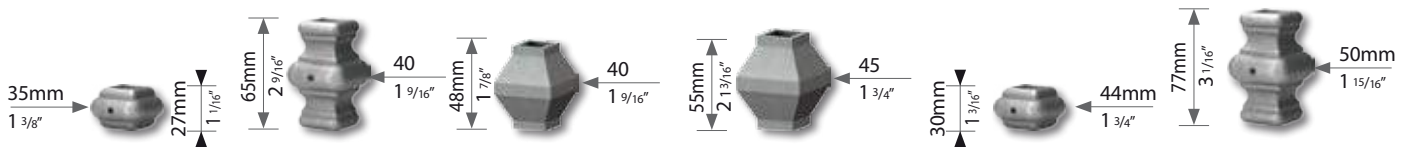

| | | | | | | | | |
|---------------|---------------|---------------|---------------|-----------------|---------------|---------------|---------------|---------------|
| 16 mm 5/8" | EGK 16 | EGK 66 | EGK 46 | 18 mm 11/16" | EGK 58 | 20 mm 3/4" | EGK 20 | EGK 80 |
|---------------|---------------|---------------|---------------|-----------------|---------------|---------------|---------------|---------------|

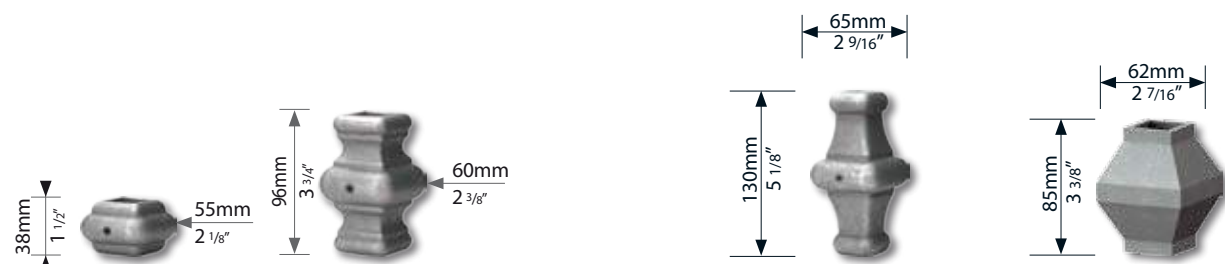

| | | | | |
|-------------|---------------|----------------|----------------|---------------|
| 25 mm 1" | EGK 25 | EGK 100 | EGK 125 | EGK 85 |
|-------------|---------------|----------------|----------------|---------------|

ACCESSOIRES - ZUBEHÖR - ACCESSORIES TOEBEHOREN - ACCESORIOS - АКЦЕССУАРЫ

Maillon de chaîne
Kettenglied
Link of chain
Kettingschakel
Eslabon de cabena
Звено цепи

Ø 115mm
Ø 4 1/2"



10 mm
3/8" Z 1153

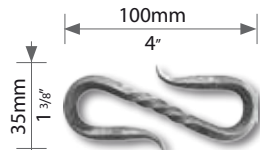

6 mm
1/4" CHA 10

74mm
2 7/8"



6 mm
1/4" Z 701

7 mm
0,28" Z 702



S: 14 mm
S: 9/16" Z 1502



| | | |
|----------------------|-----------------------|--------|
| S: 12 mm S: 1/2" | L: 155mm L: 6 1/8" | Z 1301 |
| S: 14 mm S: 9/16" | L: 155mm L: 6 1/8" | Z 1302 |
| S: 16 mm S: 5/8" | L: 200mm L: 7 7/8" | Z 1304 |



| | |
|------------------------|--------|
| S: 20 mm S: 3/4" | Z 2203 |
| S: 25 mm S: 1" | Z 2204 |
| S: 30 mm S: 1 3/16" | Z 2205 |

COLLIERS - BUNDLE - COLLARS - COLLARES - ХОМУТЫ

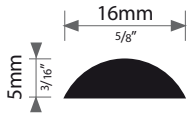

CL 14 14 mm
9/16"



CL 120 14 mm
9/16" + 14 x 6 mm
9/16 x 1/4"



CL 148 14 mm
9/16" + 16 x 8 mm
5/8 x 5/16"



CL 101 14 x 6 mm
9/16 x 1/4" + 14 mm
9/16" + 14 x 6 mm
9/16 x 1/4"



CL 102 12 x 6 mm
1/2 x 1/4" + 12 mm
1/2" + 12 x 6 mm
1/2 x 1/4"



CL 103 12 x 6 mm
1/2 x 1/4" + 12 x 6 mm
1/2 x 1/4"



CL 104 14 x 6 mm
9/16 x 1/4" + 14 x 6 mm
9/16 x 1/4"



CL 105 20 x 6 mm
3/4 x 1/4" + 20 x 6 mm
3/4 x 1/4"



CL 160 16 x 8 mm
5/8 x 5/16" + 16 x 8 mm
5/8 x 5/16"



CL 106 12 x 6 mm
1/2 x 1/4" + 12 x 6 mm
1/2 x 1/4" + 12 x 6 mm
1/2 x 1/4"



CL 107 14 x 6 mm
9/16 x 1/4" + 14 x 6 mm
9/16 x 1/4" + 14 x 6 mm
9/16 x 1/4"



CL 108 20 x 6 mm
3/4 x 1/4" + 20 x 6 mm
3/4 x 1/4" + 20 x 6 mm
3/4 x 1/4"



CL 161 16 mm
5/8" + 16 x 8 mm
5/8 x 5/16"



CL 162 16 x 8 mm
5/8 x 5/16" + 16 mm
5/8" + 16 x 8 mm
5/8 x 5/16"

FRANÇAIS : Boules pleines en fer forgé **GALVANISABLES.**

DEUTSCH : Kugeln aus geschmiedetem Eisen. **FEUERVERZINKBAR**

ENGLISH : Hot forged steel balls **SUITABLE FOR HOT DIP GALVANIZING.**

NEDERLANDS : Ronde massieve bollen. **VERZINKBAAR.**

ESPAÑOL : Bolas macizas en hierro forjado **GALVANIZABLES.**

RUSSE : Кованые горячим способом стальные шары. **Пригодны для цинкования.**



| | |
|---------------|---------------|
| Ø20 13/16" | SPP 20 |
| Ø25 1" | SPP 25 |
| Ø35 1 3/8" | SPP 35 |

| | |
|------------------|----------------|
| Ø50 1 15/16" | SPP 50 |
| Ø70 2 3/4" | SPP 70 |
| Ø100 3 15/16" | SPP 100 |

FRANÇAIS : Demi-sphères et sphères en tôle d'acier soudées et ponçées.

DEUTSCH : Halb- und Hohlkugeln aus Stahlblech verschweißt und sauber geschliffen.

ENGLISH : Hemispheres and balls made of sheet steel. With seam ground smooth.

NEDERLANDS : Halve en hele holle stalen bollen, gelast en geslepen.

ESPAÑOL : Semiesferas y esferas en chapa de acero soldadas y lijadas.

RUSSE : Полушеры и шары, изготовленные из листовой стали. С зачищенным швом.

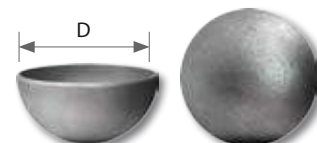
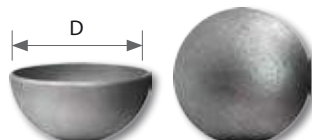

| | | | |
|-------------------|-------------------|---------------|---------------|
| Sch.40: 3/4" | D : 26,9 x 2,5 mm | DS 27* | SPM 27 |
| Sch.40: 1" | D : 33,7 x 2,5 mm | DS 33* | SPM 33 |
| Sch.40: 1 1/4" | D : 42,4 x 2,5 mm | DS 42* | SPM 42 |
| Sch.40: 1 1/2" | D : 48,3 x 2,5 mm | DS 48* | SPM 48 |
| Sch.40: 2" | D : 60,3 x 2,5 mm | DS 60* | SPM 60 |

| | | | |
|-------------------|-------------------|----------------|----------------|
| Sch.40: 2 1/2" | D : 76,1 x 2,5 mm | DS 76* | SPM 76 |
| Sch.40: 3" | D : 88,9 x 2,5 mm | DS 89* | SPM 89 |
| Sch.40: 3 1/2" | D : 101,6 x 3 mm | DS 101* | SPM 101 |
| - | D : 120 x 3 mm | DS 120* | SPM 120 |
| Sch.40: 6" | D : 153 x 3 mm | DS 153* | SPM 153 |
| Sch.40: 8" | D : 203 x 3 mm | DS 203* | SPM 203 |

***GALVANISABLES - FEUERVERZINKBAR
SUITABLE FOR HOT DIP GALVANIZING
VERZINKBAAR - GALVANIZABLES
ПРИГОДНЫ ДЛЯ ЦИНКОВАНИЯ.**

COUVRE-TUBE - ROHRABDECKUNGEN - TUBE COVERS
AFDEKBUIS - TUBO DE CUBIERTA
КРЫШКА ТРУБКИ

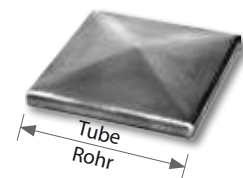
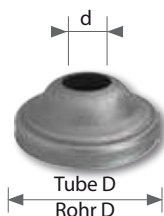

FRANÇAIS : Chapeaux couvre-tubes en tôle d'acier prévus pour recevoir par soudure une boule.

DEUTSCH : Rundrohrkappen aus Stahlblech, als Unterteil für eine Kugel, zum aufschweißen.

ENGLISH : Round post caps made of sheet steel, designed to receive by welding a ball.

NEDERLANDS : Ronde paalkappen vervaardigd uit plaatstaal, voorbereid voor aanlassen van bollen. 2 mm dik.

ESPAÑOL : Remates cubre-tubos en chapa de acero previstos para recibir, por soldadura, una bola.

RUSSE : Основания для стоек, изготовленные из листовой стали. Разработаны с учётом возможности приварить шар.

FRANÇAIS : Chapeaux couvre-tubes en tôle de fer, ép. 2 mm. À souder.

DEUTSCH : Rohrkappen aus Eisen 2 mm dick. Zum Anschweißen.

ENGLISH : Newell post caps made of 2 mm sheet steel. To be welded.

NEDERLANDS : Plaatstalen paalkappen, dik 2 mm.

ESPAÑOL : Tapa decorativa para cubrir tubos en chapa estampada de 2 mm, para soldar.

RUSSE : Крышки на столбы, изготовленные из листовой стали толщиной 2 мм. Можно приваривать.

| | |
|--------------------------------|---------------|
| 30 x 30 mm 1 3/16 x 1 3/16" | SC 30 |
| 40 x 40 mm 1 9/16 x 1 9/16" | SC 40 |
| 50 x 50 mm 2 x 2" | SC 50 |
| 60 x 60 mm 2 3/8 x 2 3/8" | SC 60 |
| 80 x 80 mm 3 1/8 x 3 1/8" | SC 80 |
| 100 x 100 mm 4 x 4" | SC 100 |
| 150 x 150 mm 5 7/8 x 5 7/8" | SC 150 |

FRANÇAIS : Couvre-tubes en acier moulé prévus pour recevoir par vissage ou soudage une sphère ou pomme de pin des pages 206 et 207.

DEUTSCH : Rohrkappen aus Schmiedeguß bestimmt für die Kugeln oder Eicheln zum anschrauben oder aufschweißen der Seiten 206 und 207.

ENGLISH : Steel casting finial base for balls or pines to be screwed or welded of pages 206 and 207.

ESPAÑOL : Cubre tubos en acero moldeado preparados para recibir atornillada o soldadura una esfera o piña de las páginas 206 y 207.

RUSSE : Крышки для столбов из литой стали, предназначенные для прикручивания или приваривания шара или сосновой шишки (см. стр. 206 и 207).

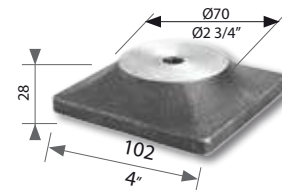
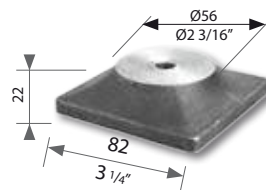
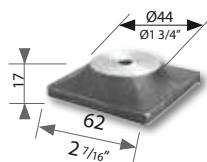
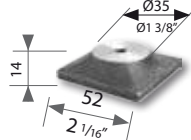
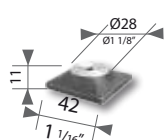

**SOUDABLES ET GALVANISABLES - SCHWEISSBAR UND FEUERVERZINKBAR - SUITABLE FOR WELDING AND GALVANIZING - GIETIJZEREN PAALKOPPEN VERZINKBAAR - SOLDABLES Y GALVANIZABLES
ПРИГОДНЫ ДЛЯ СВАРКИ И ЦИНКОВАНИЯ.**

M8 **FOC 40-ST** M10 **FOC 50-ST** M10 **FOC 60-ST** M12 **FOC 80-ST** M12 **FOC 100-ST**

CACHE-SCELLEMENTS - ROSETA EMBELLECEDOR BASE COLLARS

FRANÇAIS : Platines et cache-scellements en fer forgé à chaud.

DEUTSCH : Warm geschmiedete Abdeckrosetten.

ENGLISH : Hot forged steel base collars.

NEDERLANDS : Warm gesmede afdekrosetten.

ESPAÑOL : Pletinas y embellecedores de hierro forjado en caliente.

RUSSE : Стальные основания, выкованные горячим способом.



55mm
2 1/8"

| | |
|-------------------------|---------------|
| 12 mm 1/2" | CS 121 |
| 14 mm 9/16" | CS 141 |
| 16 mm 5/8" | CS 161 |
| 20x15 mm 13/16"x5/8" | CS 241 |

CST 1

55mm
2 1/8"

Ep. 6mm
T. 0,23"

CST 1



85mm
3 3/8"

| | |
|-----------------|---------------|
| 20 mm 13/16" | CS 201 |
| 25 mm 1" | CS 251 |

CST 2

85mm
3 3/8"

Ep. 8mm
T. 5/16"

CST 2

85mm
3 3/8"

Ø 8.5mm
Ø 0,33"

CST 5



50mm
2"

Ep. 6mm
T. 0,23"

| | |
|---------------------------|---------------|
| 12 mm 1/2" | CS 120 |
| 14 mm 9/16" | CS 140 |
| 16 mm 5/8" | CS 160 |
| 16 x 8 mm 5/8" x 5/16" | CS 168 |



70mm
2 3/4"

Ep. 6mm
T. 1/4"

| | |
|-----------------------------|---------------|
| 20 mm 13/16" | CS 200 |
| 20 x 15 mm 13/16" x 5/8" | CS 240 |



80mm
3 1/8"

Ep. 6mm
T. 1/4"

| | |
|------------------|---------------|
| 25 mm 1" | CS 250 |
| 30 mm 1 3/16" | CS 300 |



85mm
3 1/8"

Ø 8.5mm
Ø 0,33"

| | |
|-----------------|---------------|
| 20 mm 13/16" | CS 205 |
|-----------------|---------------|



60mm
2 3/8"

16 mm
5/8"

CSKF16



92mm
3 5/8"

35 mm
1 3/8"

CSKF35



60mm
2 3/8"

16 mm
5/8"

CSRF16



92mm
3 5/8"

40 mm
1 5/8"

CSRF40

FRANÇAIS : Cache-scellement en tôle ordinaire.

DEUTSCH : Abdeckrosetten aus Eisen.

ENGLISH : Base collars sheet steel.

NEDERLANDS : Afdekrozet gemaakt uit staal.

ESPAÑOL : Embellecedor de chapa.

RUSSE : Основания изготовлены из листового стали.



53mm
2 1/8"

19mm
3/4"

| | |
|----------------|--------------|
| 14 mm 9/16" | CSR 4 |
| 16 mm 5/8" | CSR 6 |



63mm
2 1/2"

25mm
1"

| | |
|-----------------|--------------|
| 16 mm 5/8" | CSR 7 |
| 18 mm 11/16" | CSR 8 |



100mm
3 15/16"

38mm
1 1/2"

| | |
|--------------------------|---------------|
| 26,9 mm Sch.40 : 3/4" | CSR 27 |
| 30 mm | CSR 30 |
| 33,7 mm Sch.40 : 1" | CSR 34 |

FRANÇAIS : Cache-scellements en fer forgé à chaud.

DEUTSCH : Warm geschmiedete Abdeckrosetten.

ENGLISH : Hot forged steel base collars.

NEDERLANDS : Warm gesmede afdekrosetten.

ESPAÑOL : Pletinas y embellecedores de hierro forjado en caliente.

RUSSE : Основания кованые горячим способом.



14mm
9/16"

60mm
2 3/8"

CS 50



25mm
1"

92mm
3 5/8"

CS 80

ABDECKROSETTEN-AFDEKROZETTEN ОСНОВАНИЯ

FRANÇAIS : Cache-scéléments en fonte grise. Livrables bruts de fonderie ou **métallisés au zinc : "Z"**.

ENGLISH : Cast iron base collars, available as cast or with **metallic zinc spray : "Z"**.

ESPAÑOL : Embellecedores en fundición gris, se sirven en bruto de fundición ó **mezalizados en zinc : "Z"**.

DEUTSCH : Grauguß Abdeckrosetten. Lieferbar roh oder **Zinkspritz metallisiert : "Z"**.

NEDERLANDS : Gietijzeren afdekrozetten, leverbaar als omschreven of **gemetalseerd : "Z"**.

RUSSE : Основания отлитые из высококачественного серого чугуна. Поставляются необработанными или оцинкованными.

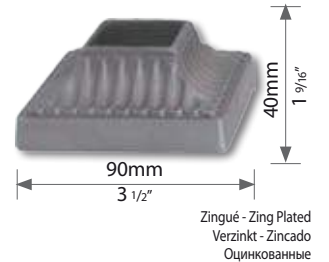
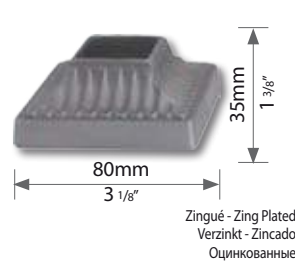
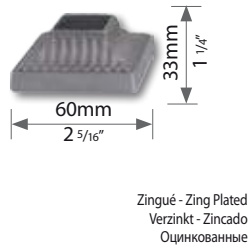
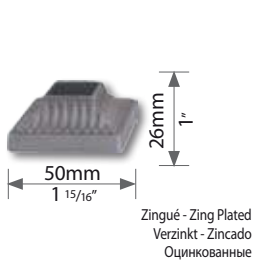

| | | |
|--------------------------|---------------|----------------|
| 14 mm 9/16" | FOC 52 | FOC 52Z |
| 16 x 8 mm 5/8 x 9/16" | FOC 53 | FOC 53Z |

| | | |
|---------------|---------------|----------------|
| 16 mm 5/8" | FOC 62 | FOC 62Z |
|---------------|---------------|----------------|

| | | |
|-----------------|---------------|----------------|
| 20 mm 13/16" | FOC 82 | FOC 82Z |
| 25 mm 1" | FOC 83 | FOC 83Z |

| | | |
|------------------|---------------|----------------|
| 30 mm 1 3/16" | FOC 85 | FOC 85Z |
| 35 mm 1 7/16" | FOC 84 | FOC 84Z |

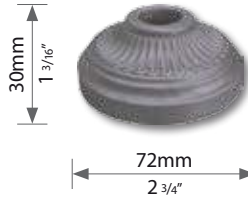

| | | |
|---------------|---------------|----------------|
| 16 mm 5/8" | FOC 16 | FOC 16Z |
|---------------|---------------|----------------|

| | | |
|-----------------|---------------|----------------|
| 18 mm 11/16" | FOC 71 | FOC 71Z |
| 25 mm 1" | FOC 72 | FOC 72Z |

| | | |
|------------------|----------------|-----------------|
| 30 mm 1 3/16" | FOC 123 | FOC 123Z |
| 40 mm 1 5/8" | FOC 124 | FOC 124Z |

| | | |
|---------------------|----------------|-----------------|
| 40 mm 1 5/8" | FOC 224 | FOC 224Z |
| 42,4 mm 1 11/16" | FOC 225 | FOC 225Z |



| | |
|-----------------|---------------|
| 20 mm 13/16" | CS 203 |
|-----------------|---------------|

CST 3

CST 7

CST 8

CST 15

Platines de fixation en fer
Eisen Bodenrosetten
Steel anchor bases
Montageringen voor spijlen en balusters
Platina de fijacion en hierro.
Стальные анкерные пластины.

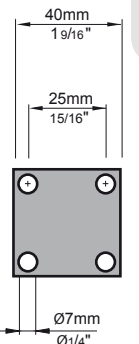
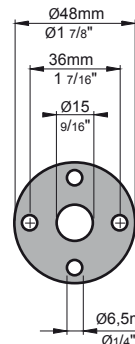
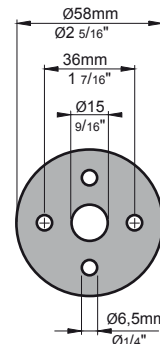
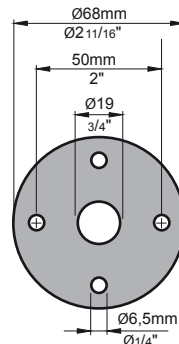
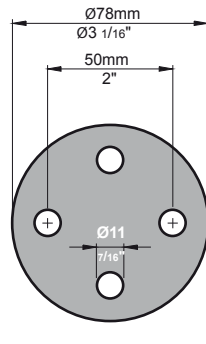
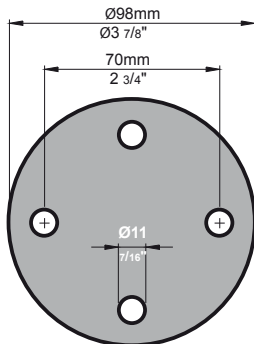

RF 100

RF 80

RF 70

RF 60

RF 50

RF 40

8 mm
5/16"

8 mm
5/16"

6 mm
1/4"

6 mm
1/4"

6 mm
1/4"

5 mm
3/16"

FEUILLES, ROSACES - BLÄTTER, ROSETTEN LEAVES, ROSETTES BLAADJES, ROZETTEN - HOJAS, ROSETONES ЛЕПЕСТКИ, РОЗЕТКИ

FRANÇAIS : Feuilles en tôle d'acier, estampées, ép. 1,2 mm

DEUTSCH : Zierblätter, 1,2 mm dick

ENGLISH : Stamped leaves. Sheet metal 1,2 mm thick

NEDERLANDS : Koud gestampte sierblaadjes, 1,2 mm dik

ESPAÑOL : Hojas estampadas en chapa de acero, grosor 1,2 mm

RUSSE : Штампованные лепестки. Листовой металл толщиной 1,2 мм.

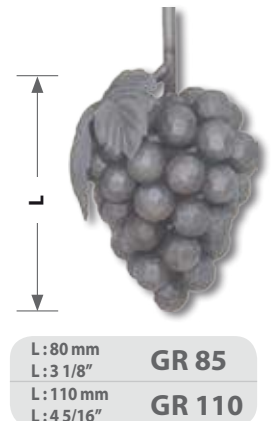
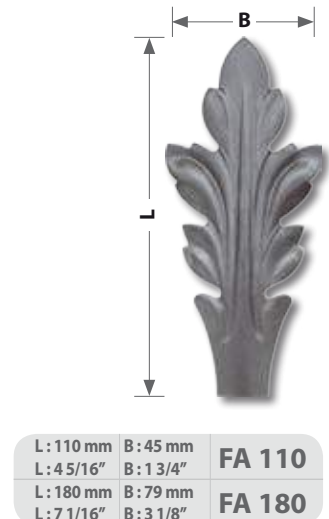
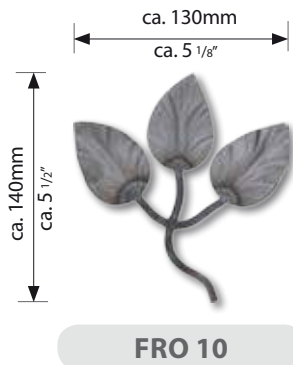
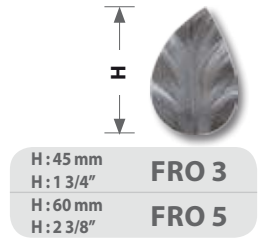
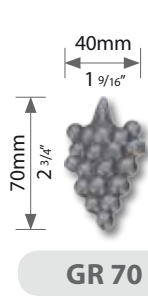
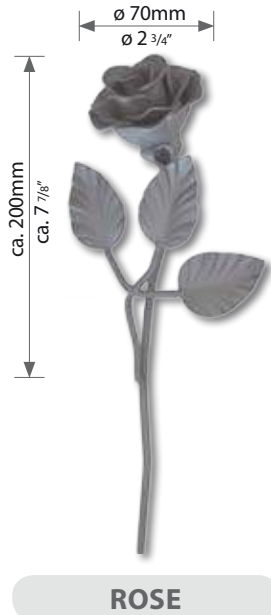

FRANÇAIS : Rosaces en fer forgé à chaud.
DEUTSCH : Zierrosetten aus geschmiedetem Stahl.
ENGLISH : Hot forged steel rosettes.
NEDERLANDS : Sierrozetten uit warm gesmeed ijzer.

ESPAÑOL : Rosetón en hierro forjado en caliente.
RUSSE : Стальные розетки кованные горячим способом.

FRANÇAIS : Rivet décoratif.
DEUTSCH : Ziernagel.
ENGLISH : Decorative-head rivet.
NEDERLANDS : Siernagel.
ESPAÑOL : Roblon decorativo.
RUSSE : Заклёпка с декоративной головкой.



FRANÇAIS : Éléments décoratifs en acier moulé DOUBLE FACE cintrables si chauffés au rouge. Soudables et galvanisables. Livrés bruts de fonderie.

DEUTSCH : Zierelemente aus Schmiedeguß, DOPPELSEITIG. Biegbar wenn rotglühend erhitzt. Schweißbar und feuerverzinkbar. Geliefert roh.

ENGLISH : DOUBLE-FACED steel castings can be re-shaped if heated. They are suitable for welding and galvanizing. Supplied in mill finish.

NEDERLANDS : DUBBELZIJDIG geprofileerde sierornamenten uit las- en verzinkbaar gietijzer. Tevens zeer goed buigbaar. Niet behandeld geleverd.

ESPAÑOL : Elementos decorativos en acero moldeado DOBLE CARA adaptables si se calientan al rojo vivo. Soldables y galvanizables. Se sirven en bruto de fundición.

RUSSE : ДВУХСТОРОННИЕ литые стальные элементы. Можно изменять форму, если нагреть. Пригодны для сварки и горячего цинкования. Поставляются в необработанном виде.

FRANÇAIS : Feuilles d'acanthé en acier moulé. Épaisseur 4 mm. **ESPAÑOL :** Hojas de acanto en acero moldeado. 4 mm. de grosor.
DEUTSCH : Akanthusblätter aus Schmiedeguß. 4 mm dick.
ENGLISH : Cast steel acanthus leaves, 4 mm (1/8").
NEDERLANDS : Acanthusbladeren uit gietstaal, 4mm dik.
RUSSE : Литые стальные листья аканта, 4 мм.

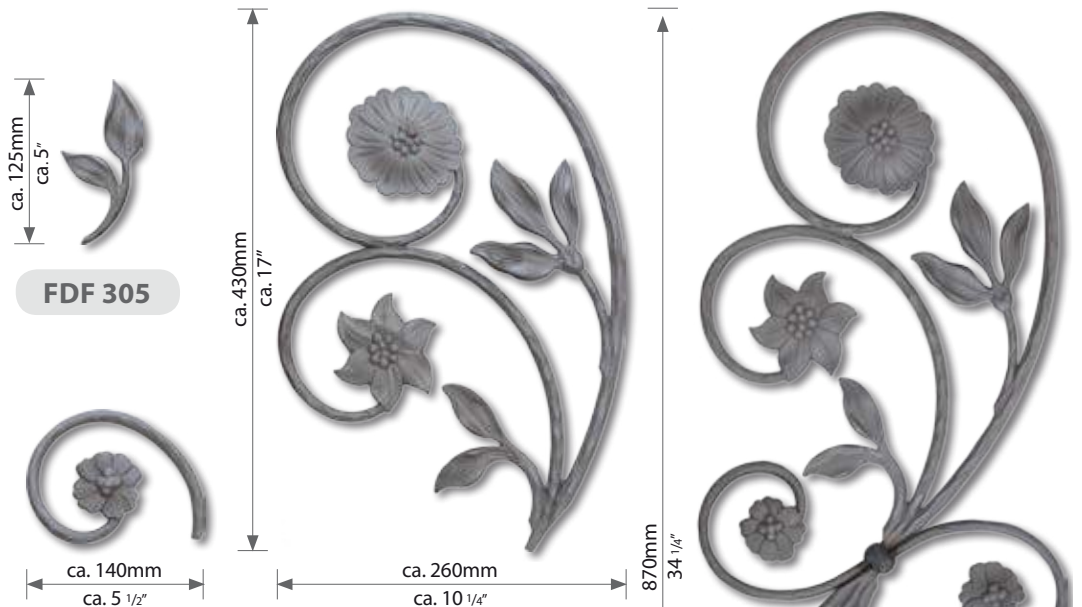

FDF 305

FDF 304

FDF 303

FDF 306

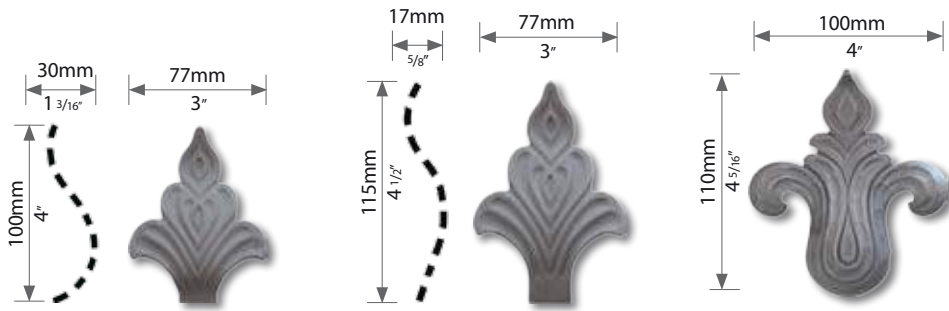

FR 91

FR 92

FR 111

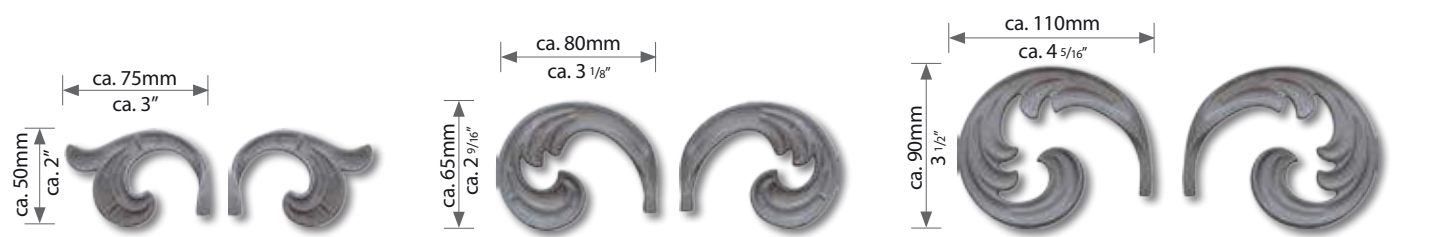

FR 66 L FR 66 R

FR 86 L FR 86 R

FR 118 L FR 118 R

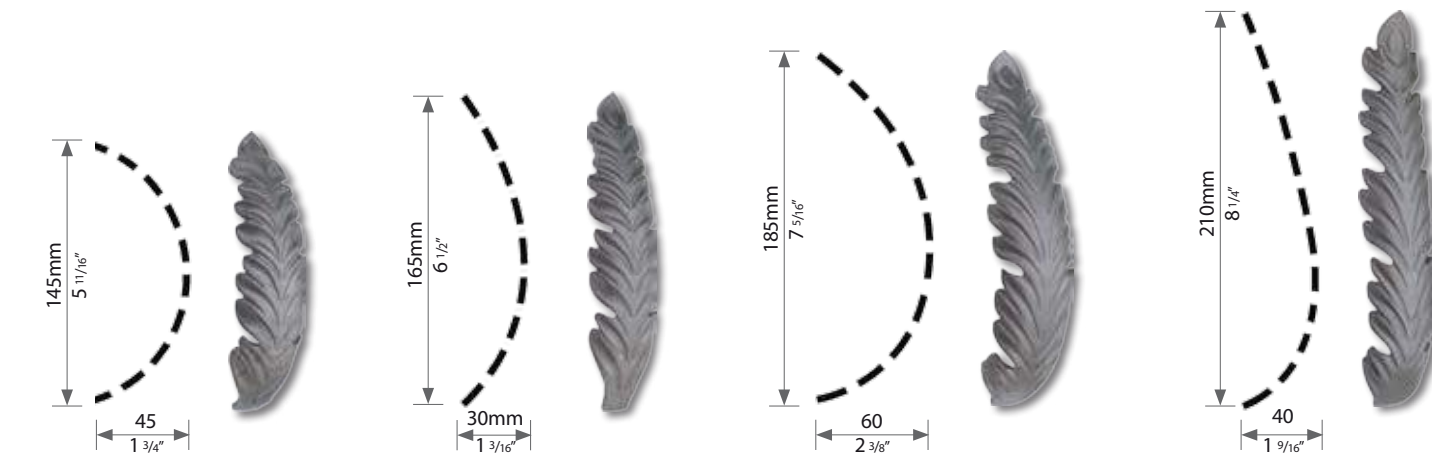

FAR 182

FAR 181

FAR 232

FAR 231

FER

ACIER MOULE DOUBLE FACE - DOPPELSEITIG SCHMIEDEGUSS DOUBLE FACED STEEL CASTINGS DUBBELZUDIG SMEEDBAAR GIETIJZER

SOUDABLES ET GALVANISABLES - SCHWEISSBAR UND FEUERVERZINKBAR - SUITABLE FOR WELDING AND GALVANIZING - TEVENS ZEER GOED BUIGBAAR
SOLDABLES Y GALVANIZABLES - ПРИГОДНЫ ДЛЯ СВАРКИ И ЦИНКОВАНИЯ

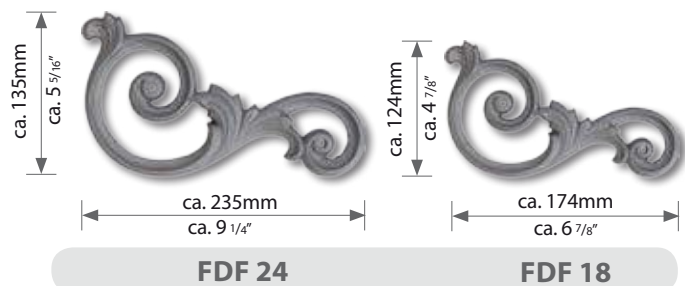
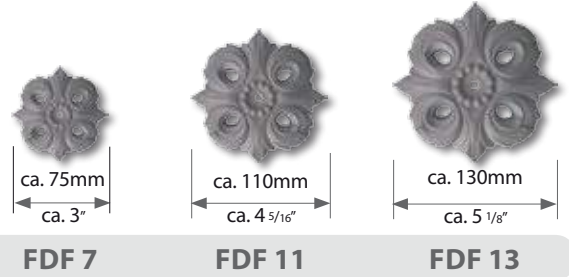
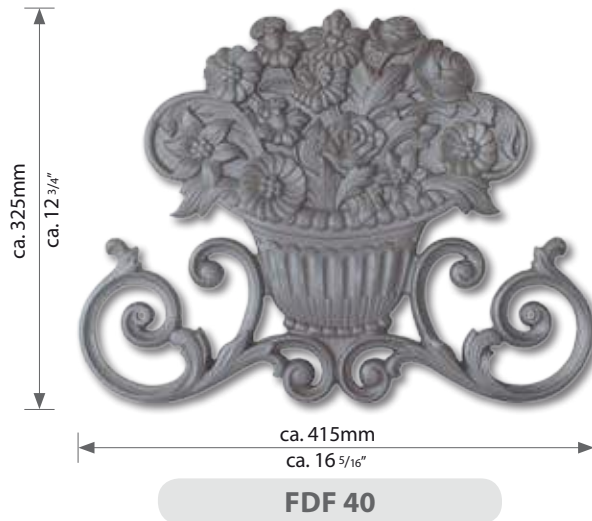
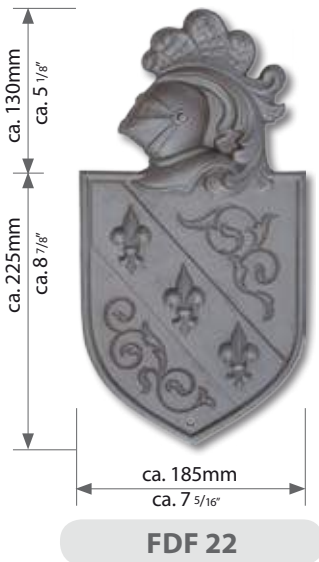
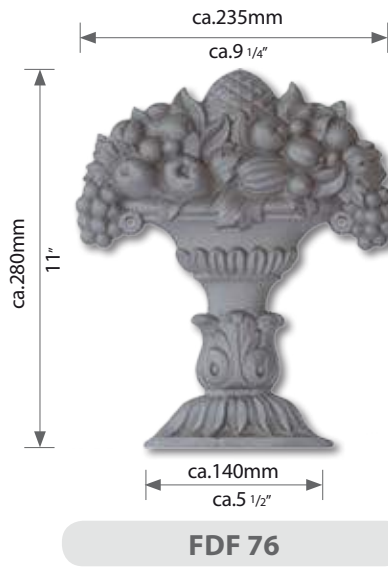
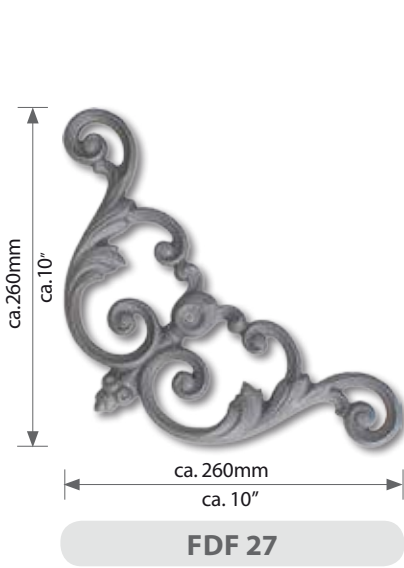

ACERO MODELADO DOBLE CERA - ЛИТЫЕ СТАЛЬНЫЕ УКРАШЕНИЯ

FRANÇAIS : Eléments décoratifs en acier moulé DOUBLE FACE, avec un encadrement en acier plat. S'agissant de pièces de fonderie, les dimensions peuvent varier légèrement, en raison du phénomène de retrait.

DEUTSCH : Zierelemente aus Schmiedeguß, DOPPELSEITIG mit Flachstahl umrahmung. Da es sich um Schmiedeguß handelt, können die Maße geringfügig abweichen.

RUSSE : ДВУХСТОРОННИЕ литые стальные элементы. Можно изменять форму, если нагреть. Пригодны для сварки и горячего цинкования. Поставляются в необработанном виде

ENGLISH : Decorative DOUBLE-FACED steel castings, with steel framings. Steel castings will shrink during the cooling process. As a result expect some variance in each casting from the dimensions shown in the catalog.

NEDERLANDS : DUBBELZIJDIG geprofileerde sierornamenten uit las- en verzinkbaar gietijzer, voorzien van frame uit strip.

Het betreft gegoten staal, geringe maatafwijkingen zijn hierbij voorbehouden.

ESPAÑOL : Elementos decorativos de acero moldeado en DOBLE CARA con un recuadro de pletina de acero. Tratándose de piezas de fundición, las dimensiones pueden variar ligeramente debido a la retracción.

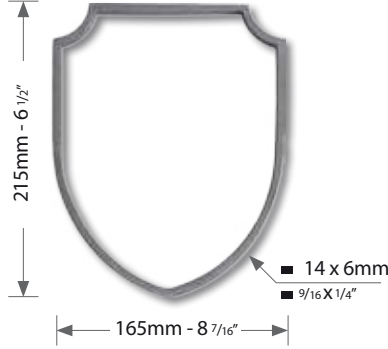

FAC 50

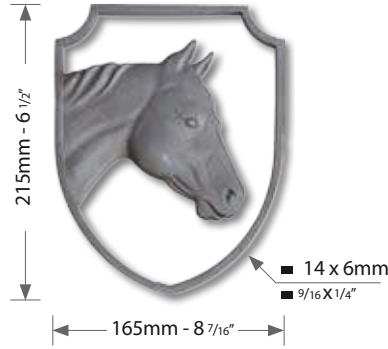

FAC 51

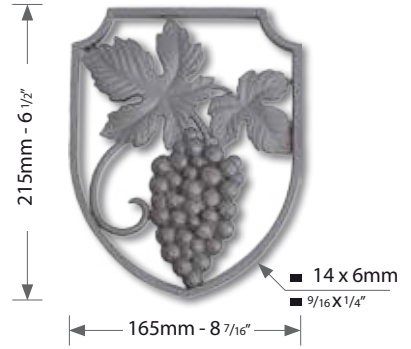

FAC 52



FAC 75



FAC 22



FAC 40

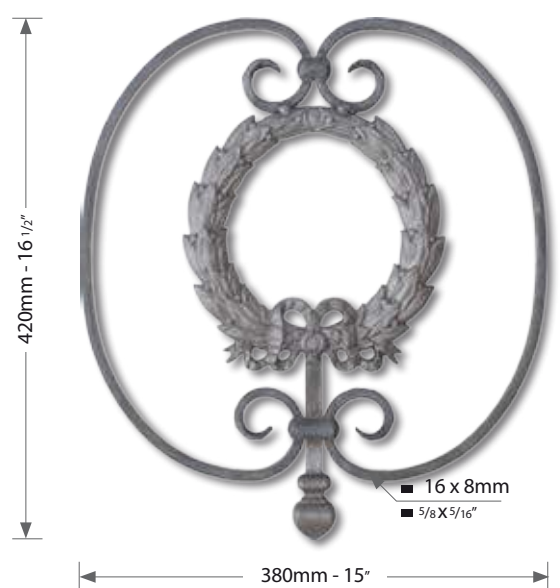

FAC 23

POINTES DE LANCE - GITTERSPITZEN - RAILING HEADS

FRANÇAIS : Pointes de lance et pontets en "fer" forgé à chaud au pilon, permettant un montage facile par soudure. Les références marquées * sont protégées par un dépôt international des dessins et modèles.

DEUTSCH : Gitterspitzen aus warm geschmiedetem "Eisen". Deshalb einfache Montage beim Schweißen. Artikel, die mit * markiert sind, haben internationalen Gebrauchsmusterschutz. Die Referenzen mit "GF" sind aus Schmiedeguß, schweißbar und feuerverzinkbar.

ENGLISH : Railing heads and spears made of hot forged "steel". These items will not break and are fully weldable. The items marked * are protected by international patent. The references with "GF" are steel castings, suitable for welding and galvanizing.

NEDERLANDS : Warm gesmede ijzeren hekpunten St. 37, las- en verzinkbaar Deze producten (*) zijn internationaal gedeponeerd op model en design en zijn van uitstekende kwaliteit. De modellen met "GF" zijn gemaakt van gietstaal, dat goed verlas- en verzinkbaar is.

ESPAÑOL : Puntas de lanza de hierro forjado en caliente con el martillo pilón. Permite el montaje fácil por soldadura. Los artículos marcados con * están protegidos con una patente internacional de diseños y modelos.

RUSSE : Наконечники пик и стоек выкованы горячим способом из стали, поэтому они прочны и легко монтируются с помощью сварки. Элементы помеченные * защищены международным патентом.

GALVANISABLES - FEUERVERZINKBAR - SUITABLE FOR HOT DIP GALVANIZING - VERZINKBAAR - GALVANIZABLES - Пригодны для цинкования.

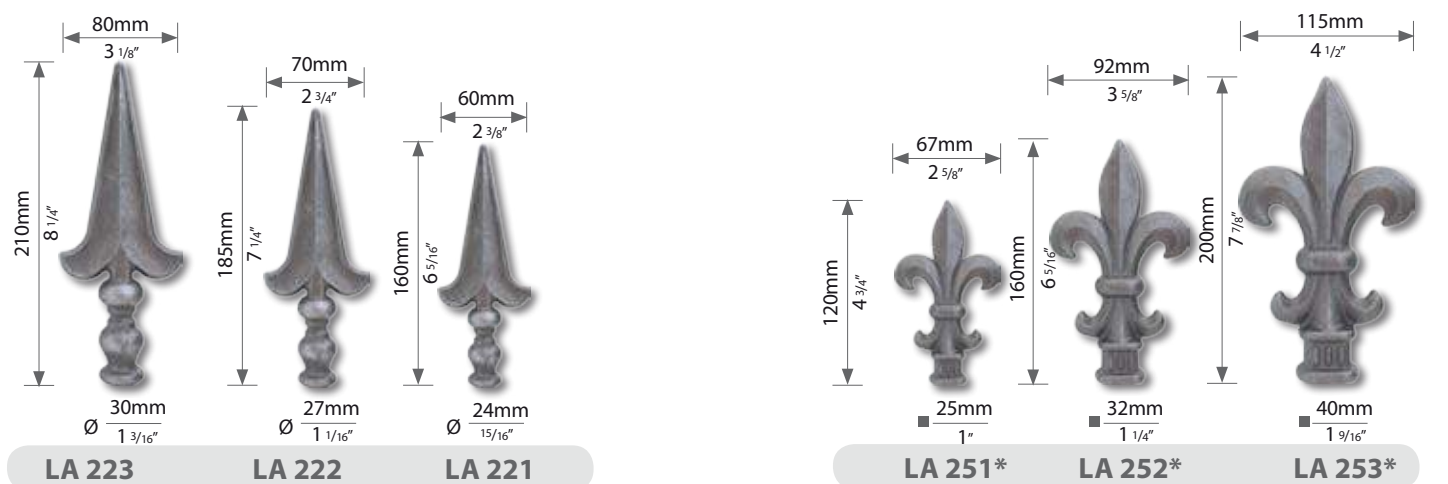
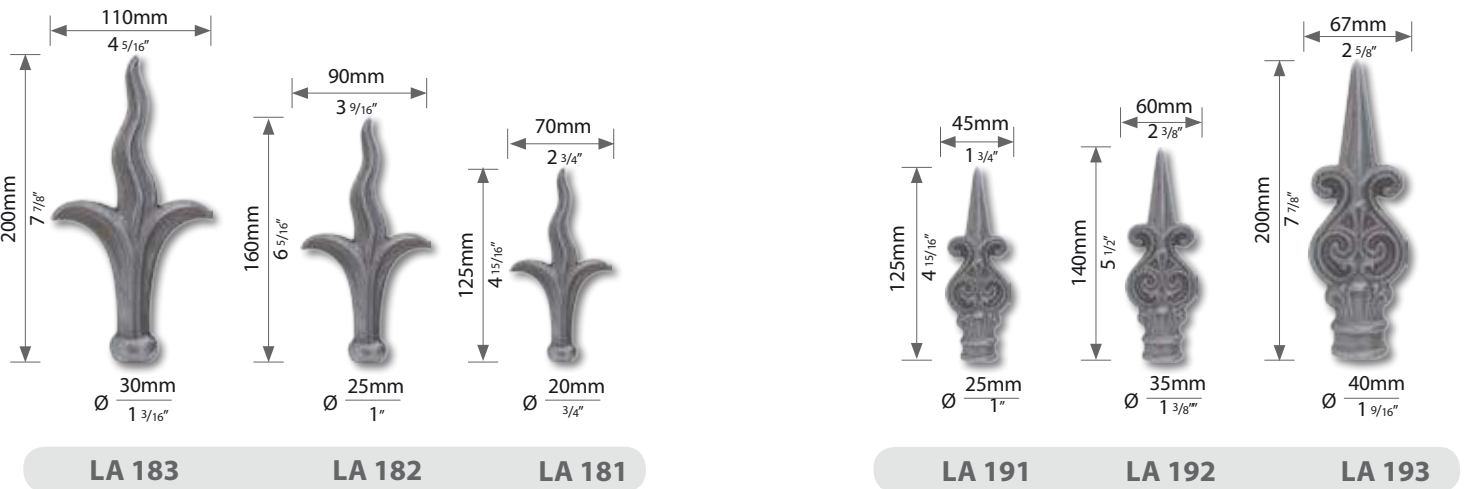
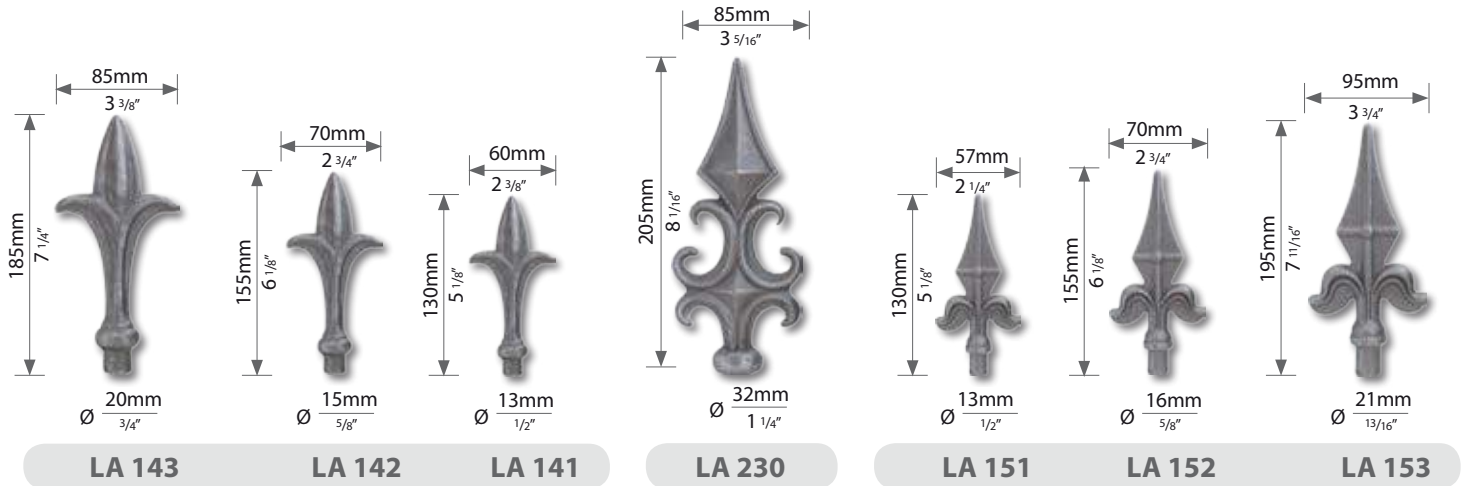

НЕКРУНТЕН - PUNTAS DE LANZA НАКОНЕЧНИКИ ДЛЯ СТОЕК

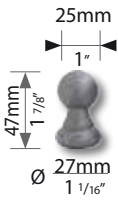

LA 31

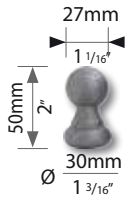

LA 32



LA 41

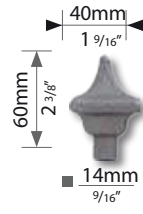

LA 45

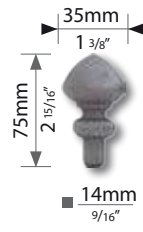

LA 51

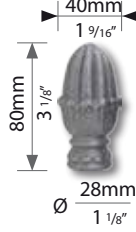

LA 111

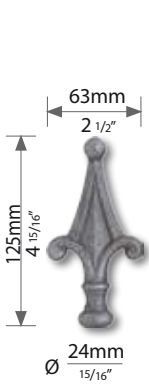

LA 211*



LA 212*



LA 213*



■ 12 mm 1/2" J 1501 JM 151

■ 14 mm 9/16" J 1502 JM 152



■ 14 mm 9/16" J 612 JM 612

■ 16 mm 5/8" J 616 JM 616

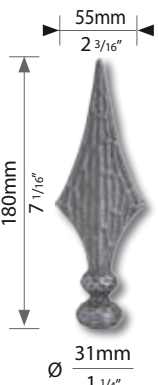

LA 103*

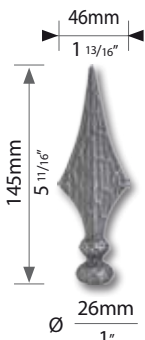

LA 101*

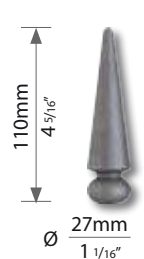

LA 171



LA 172



LA 272*

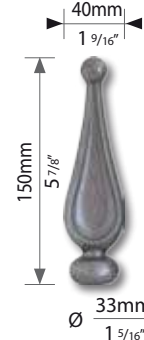

LA 273*



LA 22



LA 22M

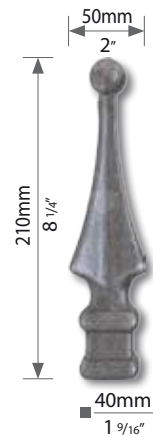

LA 163



LA 162



LA 161

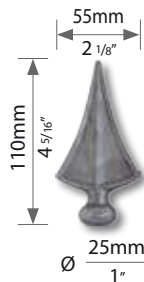

LA 231*



LA 232*

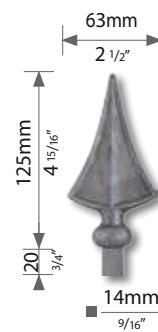

LA 237*



LA 233*

POINTES DE LANCE - GITTERSPITZEN - RAILING HEADS

FRANÇAIS : Pointes de lance et pontets en acier moulé, aptes à la soudure et la galvanisation. Les références «GF» sont destinées aux ferronniers les plus exigeants. Les références marquées * sont protégées par un dépôt international des dessins et modèles

DEUTSCH : Geformte Stahlspitzen und -sättel, zum Schweißen und Verzinken geeignet. Die Referenzen «GF» sind für die anspruchsvollsten Metallarbeiter gedacht. Die mit * gekennzeichneten Referenzen sind durch eine internationale Hinterlegung der Geschmacksmuster geschützt

ENGLISH : Molded steel spear points and saddles, suitable for welding and galvanizing. The references «GF» are intended for the most demanding metalworkers. The references marked * are protected by an international filing of the designs

NEDERLANDS : Gegoten stalen speerpunten en zadels, geschikt voor lassen en verzinken. De referenties «GF» zijn bedoeld voor de meest veeleisende metaalbewerker. De * gemarkeerde referenties worden beschermd door een internationale depot van de ontwerpen

ESPAÑOL : Puntas de lanza y monturas de acero moldeado, adecuadas para soldar y galvanizar. Las referencias «GF» están destinadas a los trabajadores metalúrgicos más exigentes. Las referencias marcadas * están protegidas por una presentación internacional de los diseños.

RUSSE : Литые стальные наконечники для наконечников и седла, пригодные для сварки и цинкования. Ссылки «GF» предназначены для самых требовательных металлистов. Ссылки, помеченные *, защищены международной регистрацией образцов.

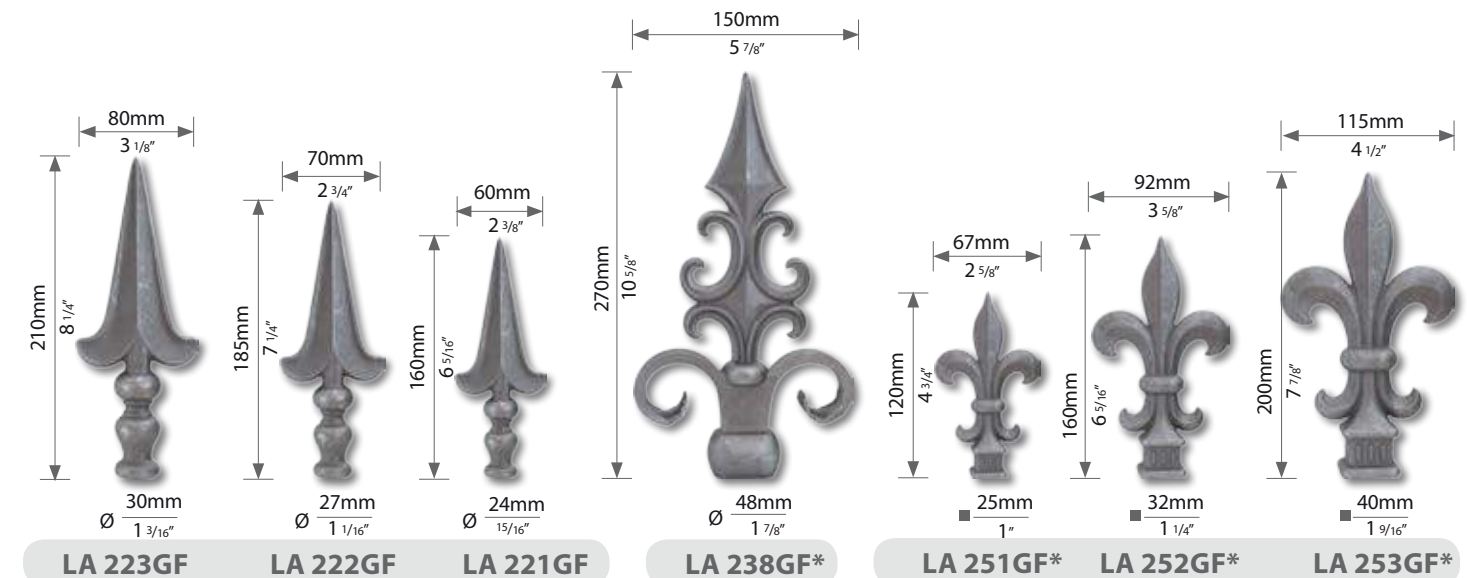
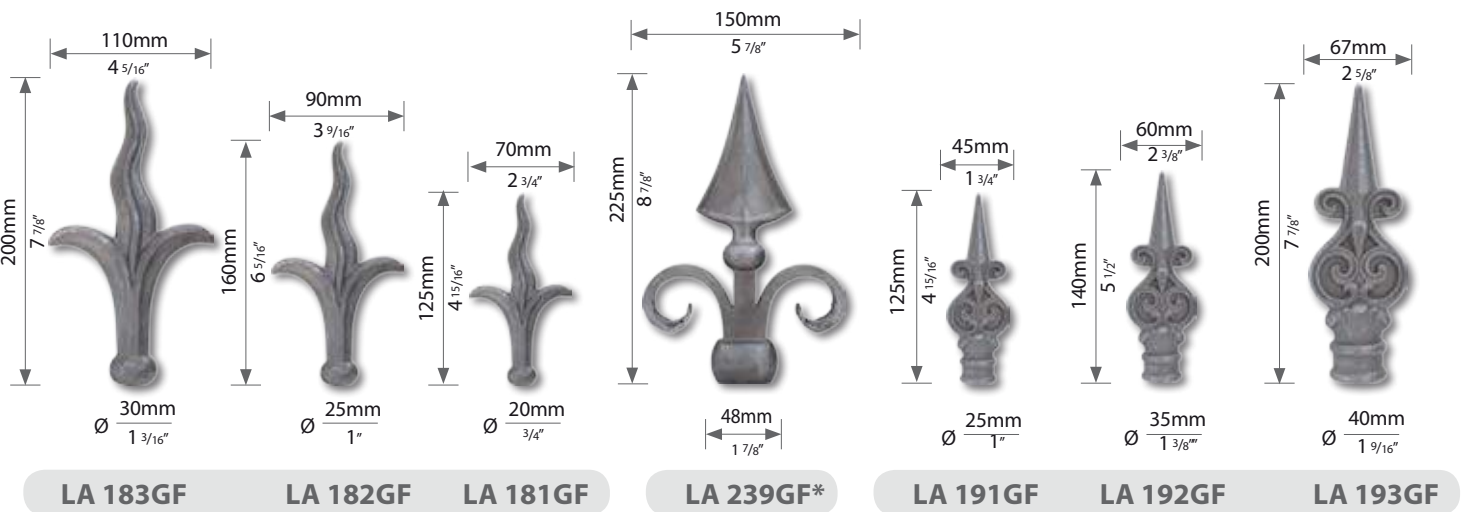
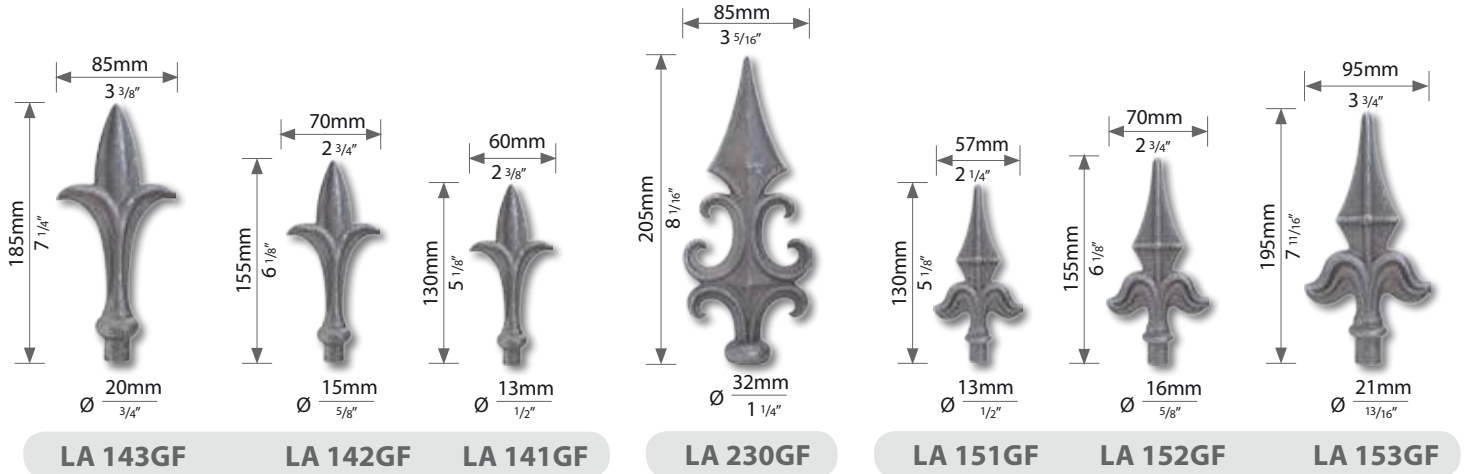

НЕКРУНТЕН - PUNTAS DE LANZA НАКОНЕЧНИКИ ДЛЯ СТОЕК

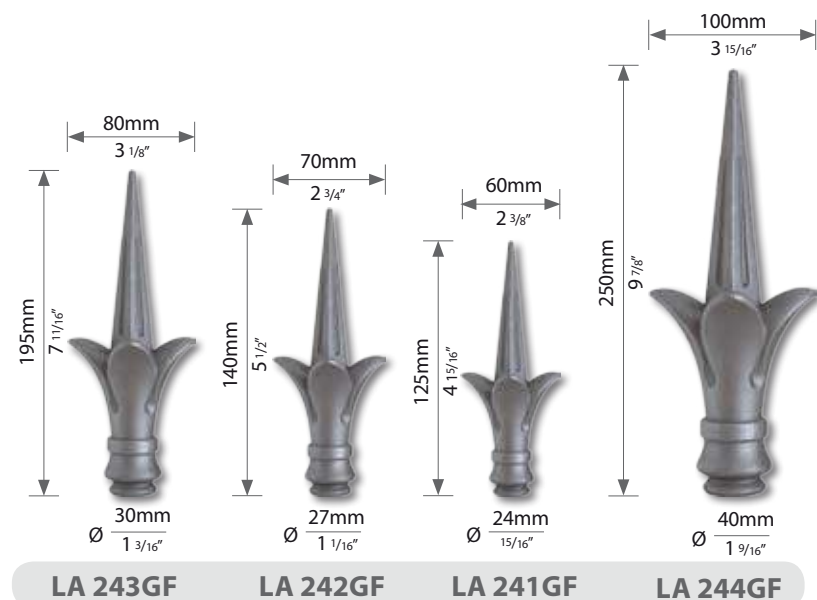
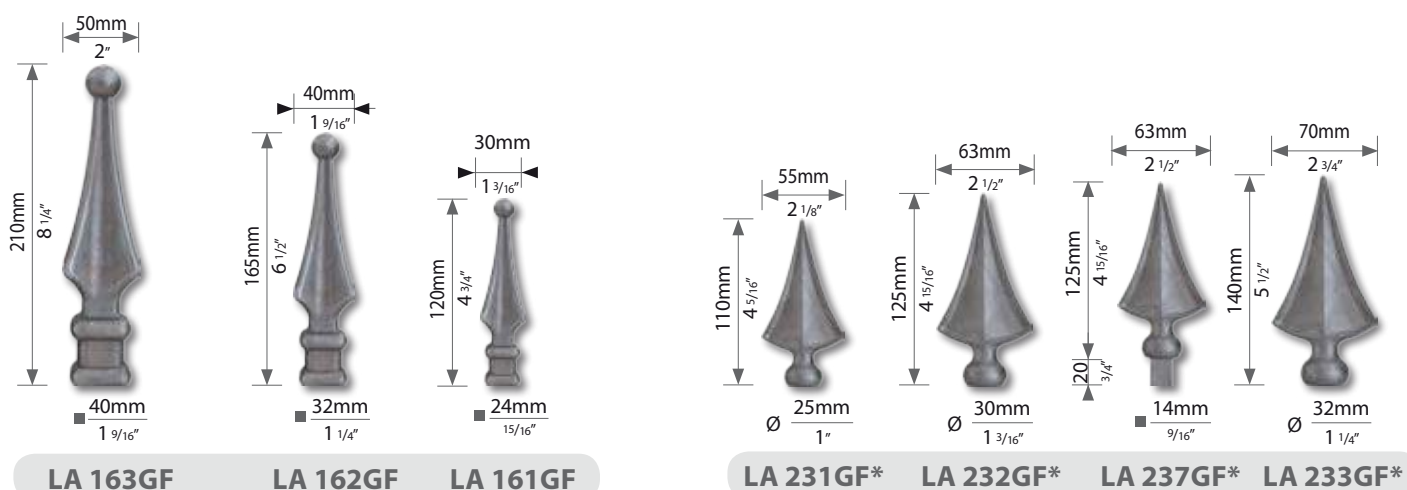
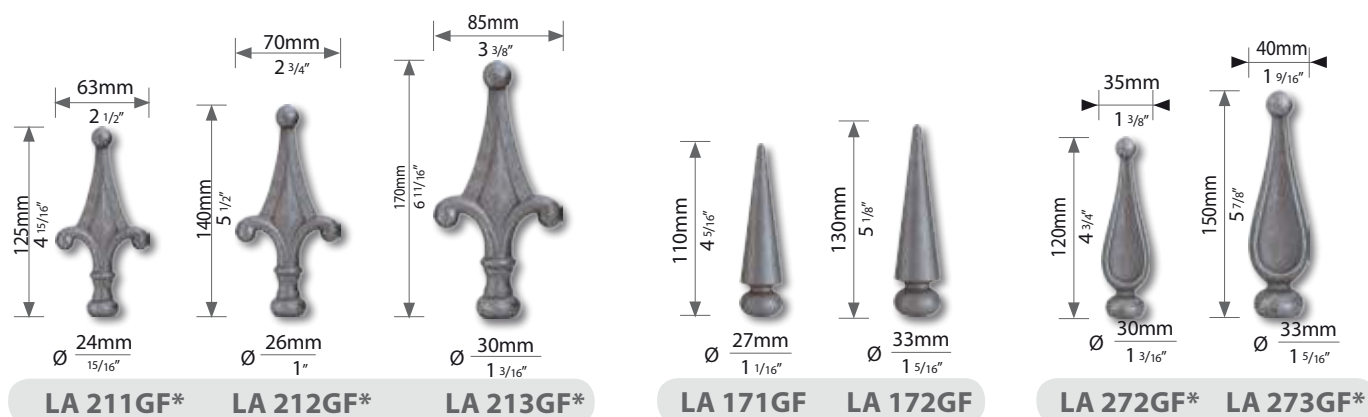
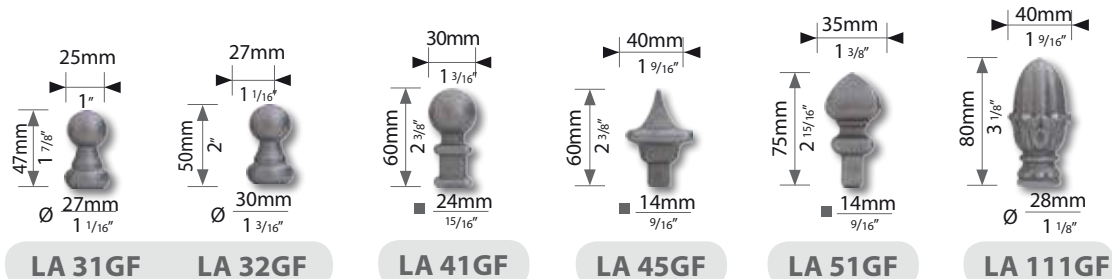

ELEMENTS DECORATIFS - ZIERELEMENTE ORNAMENTS

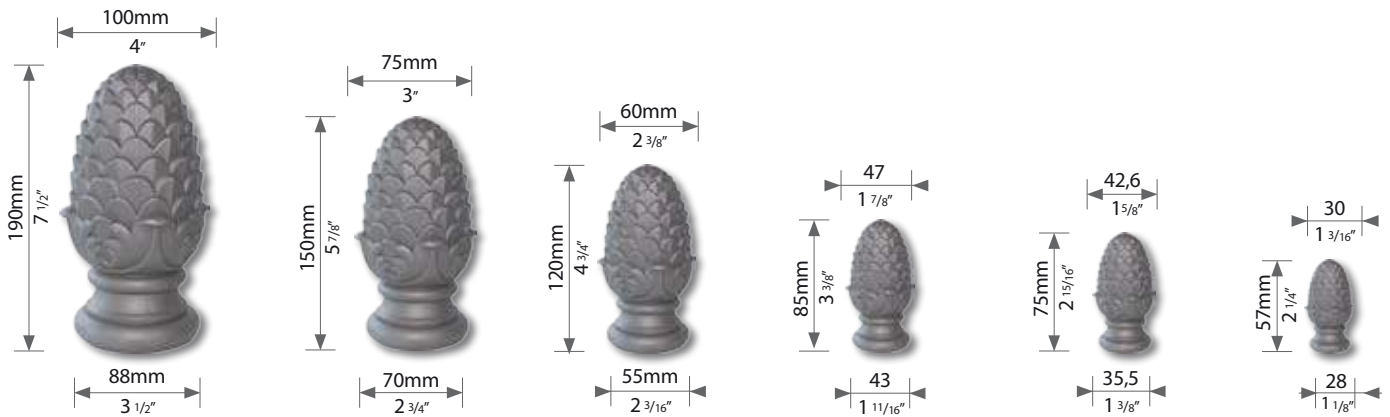

M12 FOT 19-FULL

M12 FOT 15-FULL

M10 FOT 12-FULL

M10 FOT 8-FULL

M8 FOT 7-FULL

M8 FOT 6-FULL

FRANÇAIS : Pommes de pin en acier massives prêtes à être montées. **SODABLES ET GALVANISABLES.**

DEUTSCH : Zieraufsätze aus Massivestahl zum montieren. **SCHWEISSBAR UND FEUERVERZINKBAR.**

ENGLISH : Full bodied steel casting pine cones ready to assemble. **SUITABLE FOR WELDING AND GALVANIZING.**

NEDERLANDS : Dennenappels massief staal. Gereed om te worden monteert. **LAS- EN VERZINKBAAR.**

ESPAÑOL : Pinas en acero solido. **SOLDABLES Y GALVANIZABLES.**

RUSSE : Готовые к установке сосновые шишки отлитые из стали. **Пригодны для сварки и цинкования**

M12 FOT 19-NG

M12 FOT 15-NG

FRANÇAIS : Pommes de pin creuses en acier moulé **SODABLES, NON GALVANISABLES.**

DEUTSCH : Zieraufsätze aus Schmiedeguß, **SCHWEISSBAR, NICHT FEUERVERZINKBAR.**

ENGLISH : Hollow pine in steel castings **SUITABLE FOR WELDING, NOT GALVANIZING.**

NEDERLANDS : Gietijzeren holle paalkoppen. **NIET VERZINKBAAR.**

ESPAÑOL : Pinas en acero moldeado. **SOLDABLES, NO GALVANIZABLES.**

RUSSE : Сосновые шишки отлитые из стали. **Пригодны для сварки, не оцинкованные(NG).**

ELEMENTS DECORATIFS - ZIERELEMENTE ORNAMENTS

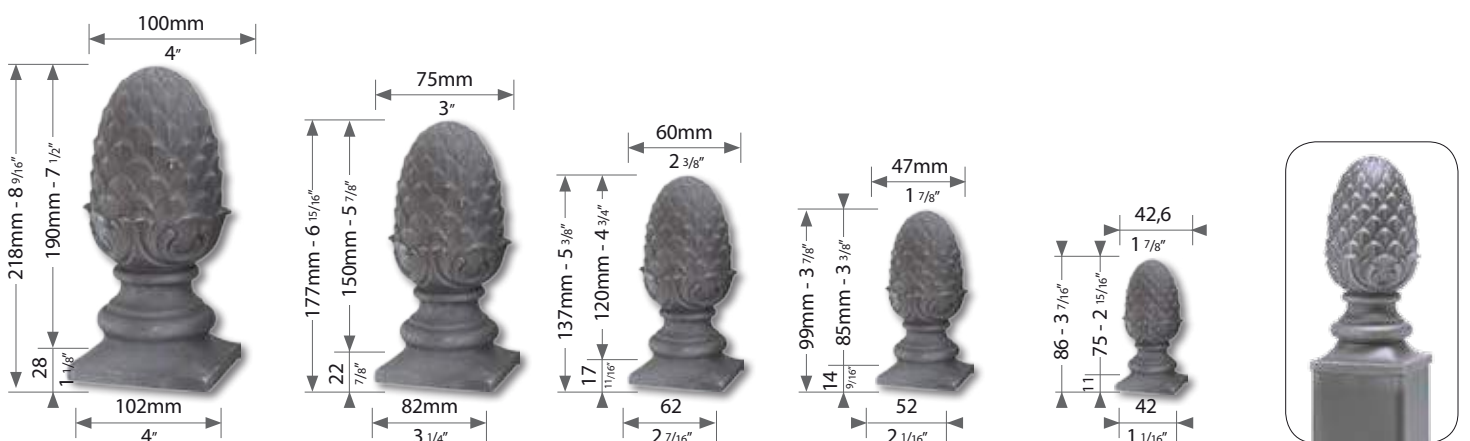

FOTC 19-FULL

FOTC 15-FULL

FOTC 12-FULL

FOTC 8-FULL

FOTC 7-FULL

FRANÇAIS : Pommes de pin en acier massives sur embases. **SODABLES ET GALVANISABLES.**

DEUTSCH : Zieraufsätze aus Massivestahl mit Sockel. **SCHWEISSBAR UND FEUERVERZINKBAR.**

ENGLISH : Full bodied steel pine cones with base. **SUITABLE FOR WELDING AND GALVANIZING.**

NEDERLANDS : Massieve stalen paalkoppen met deel. **VERZINKBAAR.**

ESPAÑOL : Pinas en acero solido con base. **SOLDABLES Y GALVANIZABLES.**

RUSSE : Сосновые шишки отлитые из стали на основании. **Пригодны для сварки и цинкования.**

FOTC 19-NG

FOTC 15-NG

FRANÇAIS : Pommes de pin creuses en acier moulé sur embases **SODABLES, NON GALVANISABLES.**

DEUTSCH : Zieraufsätze aus Schmiedeguß mit Sockel. **SCHWEISSBAR, NICHT FEUERVERZINKBAR.**

ENGLISH : Hollow pine in steel castings with base. **SUITABLE FOR WELDING, NOT GALVANIZING.**

NEDERLANDS : Gietijzeren holle paalkoppen met deel. **NIET VERZINKBAAR.**

ESPAÑOL : Pinas en acero moldeado con base. **SOLDABLES, NO GALVANIZABLES.**

RUSSE : Сосновые шишки отлитые из стали на основании. **Пригодны для сварки, не оцинкованные(NG).**

ORNAMENTEN - ORNAMENTOS УКРАШЕНИЯ

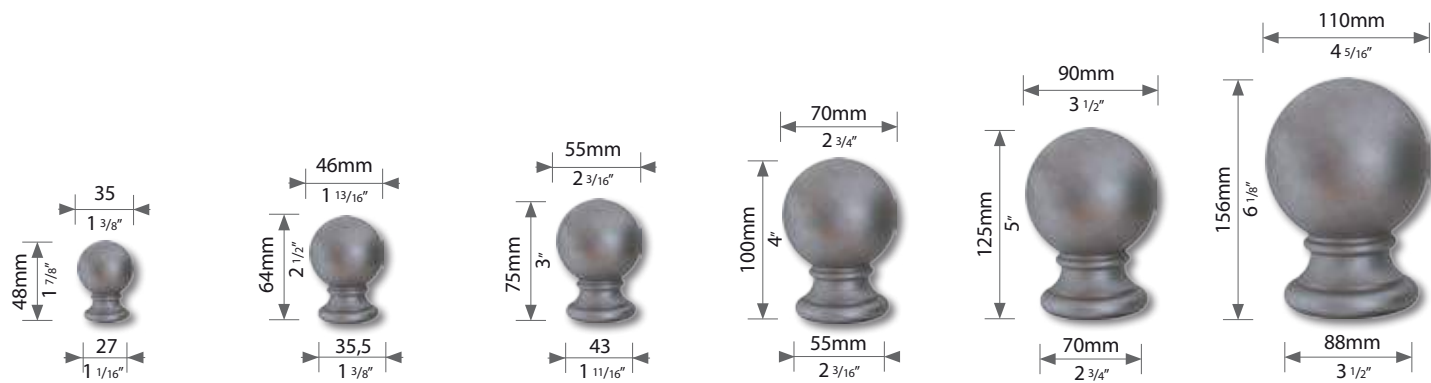

M8 **FOS 3-FULL** M8 **FOS 4-FULL** M10 **FOS 5-FULL** M10 **FOS 7-FULL** M12 **FOS 9-FULL** M12 **FOS 11-FULL**

FRANÇAIS : Sphères en acier massives prêtes à être montées. **SOUDEABLES ET GALVANISABLES.**

DEUTSCH : Kugeln aus Massivstahl zum montieren. **SCHWEISSBAR UND FEUERVERZINKBAR.**

ENGLISH : Full bodied steel casting balls ready to assemble. **SUITABLE FOR WELDING AND GALVANIZING.**

NEDERLANDS : Massieve stalen bollen. Gereed om te worden monteert. **LAS- EN VERZINKBAAR.**

ESPAÑOL : Esferas en acero solido. **SOLDABLES Y GALVANIZABLES.**

RUSSE : Готовые к установке шары отлитые из стали. **Пригодны для сварки и цинкования.**

M8 **FOS 3-NG** M8 **FOS 4-NG** M10 **FOS 5-NG** M10 **FOS 7-NG** M12 **FOS 9-NG** M12 **FOS 11-NG**

FRANÇAIS : Sphères creuses en acier moulé **SOUDEABLES, NON GALVANISABLES.**

DEUTSCH : Hohlkugeln aus Schmiedeguß, **SCHWEISSBAR, NICHT FEUERVERZINKBAR.**

ENGLISH : Hollow balls in steel castings **SUITABLE FOR WELDING, NOT GALVANIZING.**

NEDERLANDS : Gietijzere holle bollen. **NIET VERZINKBAAR.**

ESPAÑOL : Esferas huecas en acero moldeado. **SOLDABLES, NO GALVANIZABLES.**

RUSSE : Шары отлитые из стали. **Пригодны для сварки, не оцинкованные.**

ORNAMENTEN - ORNAMENTOS УКРАШЕНИЯ

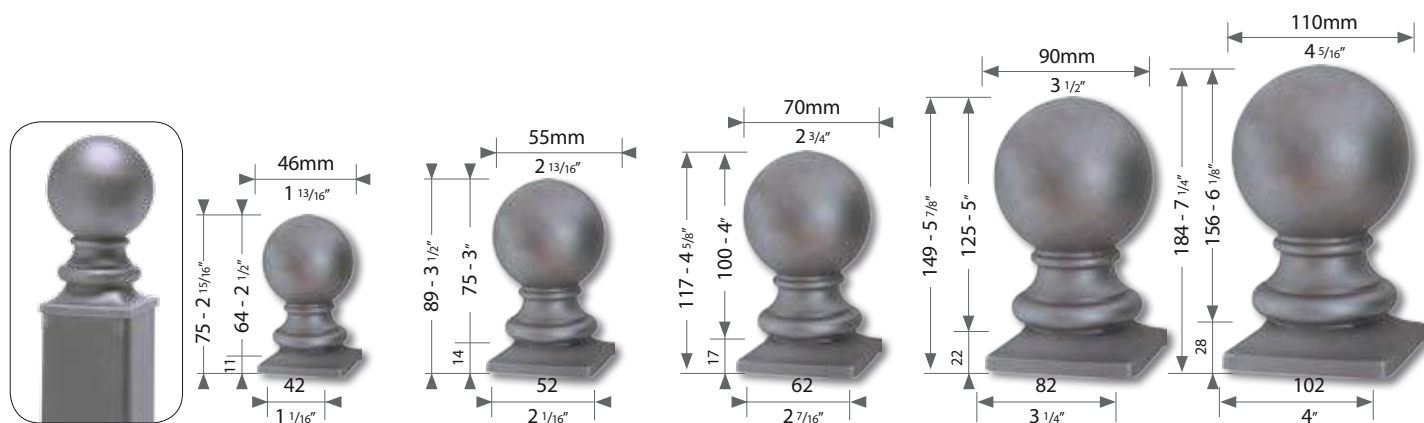

FOSC 4-FULL **FOSC 5-FULL** **FOSC 7-FULL** **FOSC 9-FULL** **FOSC 11-FULL**

FRANÇAIS : Sphères sur embases en acier massives. **SOUDEABLES ET GALVANISABLES.**

DEUTSCH : Kugeln mit Sockel aus Massivstahl. **SCHWEISSBAR UND FEUERVERZINKBAR.**

ENGLISH : Full bodied steel balls with base. **SUITABLE FOR WELDING AND GALVANIZING.**

NEDERLANDS : Massieve stalen bollen met deel. **LAS- EN VERZINKBAAR.**

ESPAÑOL : Esferas con base en acero solido. **SOLDABLES Y GALVANIZABLES.**

RUSSE : Шары отлитые из стали на основании. **Пригодны для сварки и цинкования.**

FOSC 4-NG **FOSC 5-NG** **FOSC 7-NG** **FOSC 9-NG** **FOSC 11-NG**

FRANÇAIS : Sphères creuses sur embases en acier moulé **SOUDEABLES, NON GALVANISABLES.**

DEUTSCH : Hohlkugeln mit Sockel aus Schmiedeguß, **SCHWEISSBAR, NICHT FEUERVERZINKBAR.**

ENGLISH : Hollow balls with base in steel castings **SUITABLE FOR WELDING, NOT GALVANIZING.**

NEDERLANDS : Gietijzere holle bollen met deel. **NIET VERZINKBAAR.**

ESPAÑOL : Esferas con base huecas en acero moldeado. **SOLDABLES, NO GALVANIZABLES.**

RUSSE : Шары отлитые из стали на основании. **Пригодны для сварки, не оцинкованные.**

SERRURERIE - TORZUBEHÖR - HARDWARE

FRANÇAIS : Béquilles et bouton en fer. Femelle avec vis pointeau pour tige carrée de 8 mm (non comprise). Protection anticorrosion par DACROMET®. Option : Patiné à la main "Fer Naturel" : P

DEUTSCH : Drücker und Drehknopf mit Befestigungsschraube, jedoch ohne Stift. DACROMET® beschichtung, passend für 8 mm Stift. Option : "Eisen natur" Hand patiniert : P

ENGLISH : Lever handles and knob made of iron, equipped with locking screws, but without the 8 mm (5/16") square rod. DACROMET® coated. Option : Hand patinated "Natural Steel" : P

NEDERLANDS : Poort/deurkrukken en -knop incl. evestigingsschroeven, excl. stift 8mm. DACROMET® bekleding. Optie: handgepatineerd "Naturel-metaalkleur" : P

ESPAÑOL : Palanca de apoyo y botón en hierro. Hembra con tornillo puntiagudo para varilla cuadrada de 8 mm.(sin pasador). Protección anticorrosiva para DACROMET®. Opcional : Patinado a mano "Hierro viejo" : P

RUSSE : Ручки изготовлены из металла, поставляются со стопорными винтами, но без 8-мм квадратного стержня с помощью покрытия DACROMET®. Оцинкованы. Дополнительно поставляются: ручки, окрашенные под цвет "естественной стали": "P".

Idem à ci-contre, mais bouton fixe.

Idem wie nebenstehend, aber mit festem Knopf.

Idem as opposite, but with fixed knob.

Idem als nebenstehend, echter met vaste knop.

Igual a los anteriores, pero con puño fijo.

Такой же как рядом, но с фиксатором.



| | | | | | | | | | |
|--------|------------------|-----------|------------------|-----------|-----------------|----------|----------------|----------|----------------|
| Brut | SEP 13 L | Raw | SEP 13 R | сырье | SEP 12 | Roh | SEP 7 | Bruto | SEP 8 |
| Patiné | SEP 13 LP | Patinated | SEP 13 RP | С патиной | SEP 12 P | Patinier | SEP 7 P | Patinado | SEP 8 P |

FRANÇAIS : Tiges carrées de 8 mm

DEUTSCH : 8 mm Stift und Wechselstift

ENGLISH : 8 mm - 5/16" square rods

NEDERLANDS : Wisselstift, 8 mm vierkant

ESPAÑOL : Varillas cuadradas de 8 mm

RUSSE : Квадратный штырь, 8 мм



SEK 6

SEK 11

FRANÇAIS : Cylindre en laiton - 4 goupilles.

DEUTSCH : Schließzylinder aus Messing, 4 Stiftzuhaltungen.

ENGLISH : Dual cylinder made of brass - 4 pins.

NEDERLANDS : Messing cilinder met 4 stiften, inclusief schroef en 3 sleutels.

ESPAÑOL : Bombillos de cierre en latón con 4 pasadores.

RUSSE : Двойной 4-штырьковый цилиндрический латунный механизм.



Fermetures différentes
Verschiedene Schließungen
Different lockings
Niet gelijksluitend
Cerraduras diferentes
Различное запираение

Fermetures identiques
Gleichschließend
Identical lockings
Gelijksluitend
Cerraduras idénticas
Одинаковое запираение.

L : 40 mm
L : 1 9/16"
L : 54 mm
L : 2 1/8"

SEC 40

SEC 40 S

SEC 54

SEC 54 S

FRANÇAIS : Serrure galvanisée à pêne réversible pour usage gauche ou droite. Pêne dormant 1 tour - sans le barillet

DEUTSCH : Verzinktes Schloß - 1 tourig. Links und Rechts verwendbar durch umdrehbaren Fallenkopf - ohne Zylinder.

ENGLISH : Galvanized lock - 1 Tour deadbolt. The springlatch is reversible for right or left hand use. Cylinder sold separately.

NEDERLANDS : Slot, verzinkt - 1-toerig. Links en rechts omkeerbaar, excl. cilinder.

ESPAÑOL : Cerrojo galvanizado con resbalón reversible a derecha e izquierda. El pestillo cierra con una vuelta. Se sirve sin bombillo.

RUSSE : Оцинкованный замок с реверсивной щеколдой для использования в левую или правую сторону. Неподвижная щеколда (1 оборот, без цилиндрического механизма).

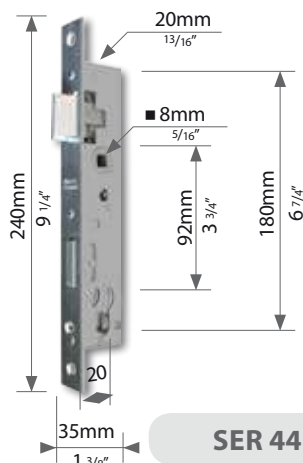

SER 44

FRANÇAIS : Têtière en acier galvanisé, ép. 3mm.

DEUTSCH : Schließblech, 3 mm, verzinkt.

ENGLISH : Striking plate - zinc plated.

NEDERLANDS : Sluitplaat, 3mm, verzinkt.

ESPAÑOL : Frente en acero galvanizado. Espesor 3 mm.

RUSSE : Накладка из стали (толщина: 3 мм).



E: 24 mm
E: 15/16"
E: 33 mm
E: 1 5/16"

SEB 39

SEB 49

FRANÇAIS : Plaque en acier électrozinguée martelée sur les angles. Epaisseur 3mm.

DEUTSCH : Kantengehämmerter Platte aus Stahl verzinkt. 3 mm dick.

ENGLISH : Steel plate with hammered edges. Zinc plated. 3 mm thick.

NEDERLANDS : Kantgehamerde Verzinkte stalen plaat. 3mm dik.

ESPAÑOL : Placa de acero con los bordes martillado. Zincado. 3 mm de espesor.

RUSSE : Кованная накладка из стали, прошедшая электролитическое цинкование и скованная по углам (толщина: 3 мм).

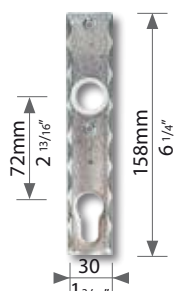

SEB 59

FRANÇAIS : Plaques décoratives en tôle d'acier, épaisseur 4 mm forgée à chaud.

DEUTSCH : Schloßblende, warm geschmiedet, Blechstärke 4 mm.

ENGLISH : Decorative plates of hot forged sheet steel, 4 mm thick.

NEDERLANDS : Warm gesmede sierplaten voor montage op de door ons te leveren slotkasten en tegenkasten. Dikte 4 mm.

ESPAÑOL : Placas decorativas de chapa de acero forjada en caliente, 4 mm de grosor.

RUSSE : Декоративные кованные накладки из листовой стали толщиной 4 мм.

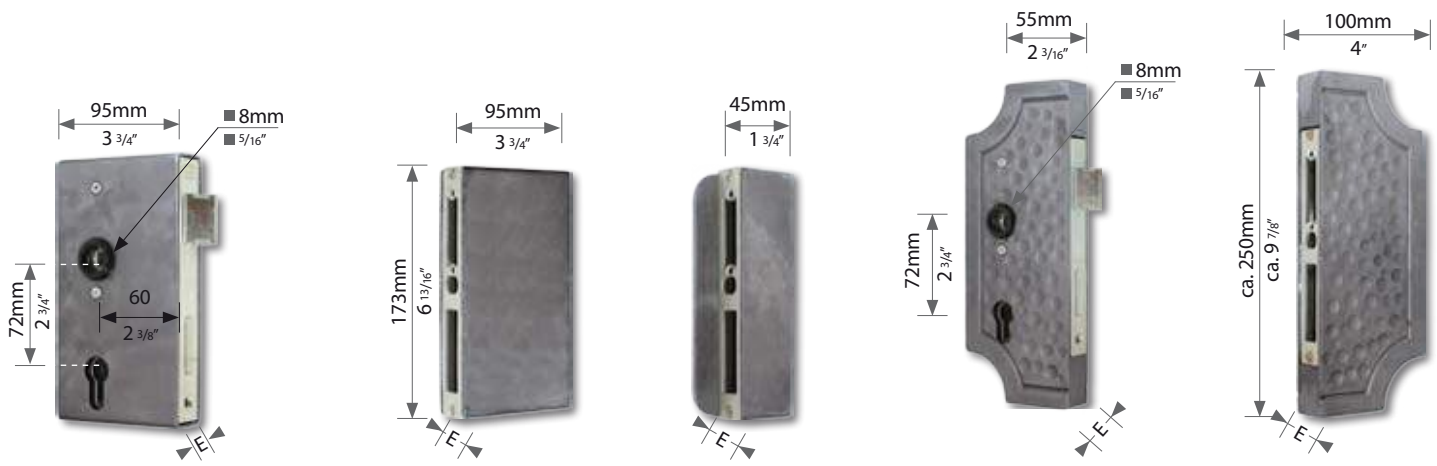
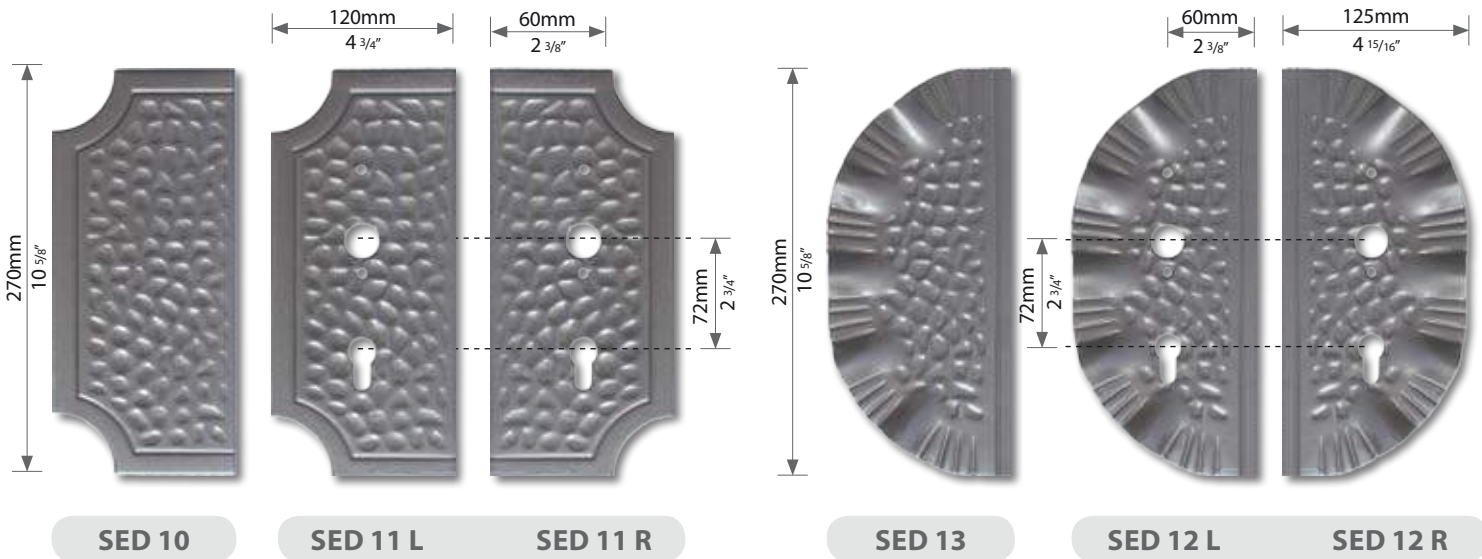

| | | | | | |
|------------------------|---------------|---------------|---------------|---------------|---------------|
| E: 30 mm E: 1 3/16" | SER 30 | SEB 31 | SEB 32 | SER 37 | SEB 38 |
| E: 40 mm E: 1 9/16" | SER 40 | SEB 41 | SEB 42 | SER 47 | SEB 48 |

FRANÇAIS : Boîtiers en acier à souder avec serrures galvanisées. Pêne réversible pour usage gauche ou droite. Pêne dormant à 2 tours – Sans le barillet. Contre boîtes, à souder, sans butée. Têtière réversible, prévue pour montage d'une gâche électrique.

DEUTSCH : Schloßkästen aus Stahl, zum Anschweißen, mit verzinkten Schlössern. 2 tourig- Links und Rechts verwendbar durch umdrehbaren Fallenkopf-ohne Zylinder. Gegenkästen aus Stahl, ohne Anschlag. Links und Rechts verwendbar. Für elektrischen Türöffner vorge richtet.

ENGLISH : Steel Lockboxes to be welded, with galvanized locks. 2 Tours deadbolts. The springlatch is reversible for right or left hand use. Locking cylinder sold separately. Steel Counterboxes, to be welded. The face plates are reversible and accept electric strikes.

NEDERLANDS : Slotkasten in staal, lasbaar, met verzinkte sloten. Rechts en links omkeerbaar doormiddel van draaibare

dagschoot- 2 toerig-zonder cilinder. Tegenkasten in staal, zonder aanslag. Rechts en links toepasbaar. Voorbereid voor elektrische deuropeners.

ESPAÑOL : Cuerpo de cerrojo en acero para soldar con cerrojo galvanizado. El resbalón es reversible a derecha e izquierda y el pestillo cierra con dos vueltas. Se sirve sin bombillo. Contra-cuerpo de cerrojo sin retención, para soldar. Cabezal reversible previsto para el montaje de una gacheta eléctrica.

RUSSE : Сварные кожухи для замков, изготовленные из стали, и оцинкованные замки. Два оборота. Пружинящий язычок можно переустанавливать на левую или правую сторону. Замок поставляется без цилиндрического механизма. Накладки сварные. Декоративные пластины можно устанавливать на любую сторону. Возможна установка электрического устройства.

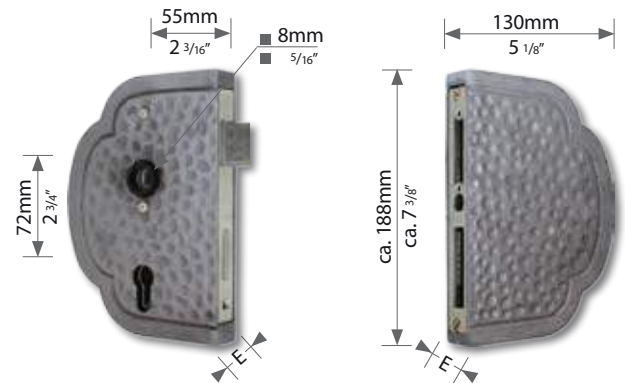

| | | |
|------------------------|---------------|---------------|
| E: 30 mm E: 1 3/16" | SER 35 | SEB 36 |
| E: 40 mm E: 1 9/16" | SER 45 | SEB 46 |

FRANÇAIS : Vis écrous à tête forgée décorative en pointe de diamant.

Ne pas utiliser pour fixer des RF. Couple maximum limité à 18N.m.

DEUTSCH : Zierkopfschrauben, nicht geeignet zur Befestigung der Bodenrosetten RF. Maximales Drehmoment beschränkt auf 18N.m.

ENGLISH : Forged nail-headed screws and nuts. Decorative screws are not suitable for fastening the RF anchor bases. The maximum torque is 18N.m.

NEDERLANDS : Warm gesmede sierkopfschroeven. Sierkopfschroeven, niet geschikt voor bevestiging van bevestigingsrozetten RF. Maximum draaimoment is 18N.m.

ESPAÑOL : Tornillo y tuerca con cabeza forjada con punta de diamante. Tornillo decorativo, no utilizar para fijar las pletinas RF. Par máximo limitado a 18 N.m.

RUSSE : Саморезы, с кованными декоративными плоскими головками. Не использовать для крепления анкерных пластин(RF). Максимальный затягивающий момент – 18 Н/м.

FRANÇAIS : Vis de sécurité en acier trempé à sens unique : Dévissage impossible.

DEUTSCH : Einweg-Sicherheits-Schraube aus gehärtetem Stahl. Die Schrauben können nicht mehr herausgedreht werden.

ENGLISH : One way security screw, heat threaded (5/16" x 3"). Unscrewing will be impossible.

NEDERLANDS : Veiligheidsschroef uit gehard staal. Deze kan na montage niet meer losgedraaid worden.

ESPAÑOL : Tornillo unidireccional de seguridad de acero templado. Una vez atornillado ya no puede destornillarse.

RUSSE : Неотвинчиваемые предохранительные винты. Невозможно открутить.

FRANÇAIS : Vis de sécurité indéserrable, par rupture de la tête hexagonale.

DEUTSCH : Abscheer-Sicherheits-Schraube. Sechskant-Kopf reißt bei einem bestimmten Druckpunkt ab.

ENGLISH : Security lock screw, by breaking off the hexagonal head.

NEDERLANDS : Veiligheidsbout met zeskante kop die na montage is afgedraaid. Daarna is de bout niet meer te demonteren.

ESPAÑOL : Tornillo de seguridad indestornillable si se rompe la cabeza hexagonal.

RUSSE : Предохранительные стопорные болты с отламывающейся шестигранной головкой.

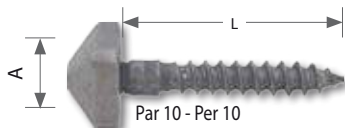

| | | | |
|-----------------|--------------------------|------------------------|---------------|
| Par 10 - Per 10 | | | |
| 6 mm 1/4" | L : 36 mm L : 1 7/16" | A : 14 mm A : 9/16" | VB 640 |
| 8 mm 5/16" | L : 56 mm L : 2 3/16" | A : 16 mm A : 5/8" | VB 860 |

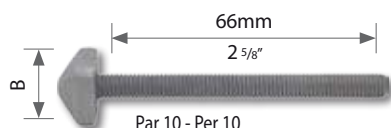

| | | | |
|-----------------|---------------|------------------------|--|
| Par 10 - Per 10 | | | |
| M6 | VM 670 | B : 14 mm B : 9/16" | |
| M8 | VM 870 | B : 16 mm B : 5/8" | |



| | | | |
|-----------------|-------------|------------------------|--|
| Par 10 - Per 10 | | | |
| M6 | VE 6 | C : 14 mm C : 9/16" | |
| M8 | VE 8 | C : 16 mm C : 5/8" | |



| | | | |
|-----------------|--------------------------|---------------|--|
| Par 10 - Per 10 | | | |
| 8 mm 5/16" | L : 50 mm L : 1 9/16" | VSU 50 | |
| 8 mm 5/16" | L : 70 mm L : 3" | VSU 70 | |



| | |
|-----------------|---------------|
| Par 10 - Per 10 | |
| M10 | VH 108 |

PEINTURES - FARBEN - PAINTS - KLEUREN PINTURAS - КРАСКИ

FRANÇAIS : Patines à appliquer au "pinceau sec" sur ferronneries peintes : 0,25 L avec 0,25 L de diluant spécial. Ne pas exposer à une température supérieure à 80°C (risque de décoloration).

DEUTSCH : Patina-Farben zum Auftragen mit „trockenem Pinsel“ auf behandeltes Schmiedeeisen : 0,25 L mit 0,25 L spezial Verdünnung. Umgebungstemperatur nicht höher als 80°C (Entfärbungsrisiko).

ENGLISH : Patinas to be applied by «dry brush» method on painted steel (combine 0.25L with 0.25L special thinner). Paint colors will fade if exposed to temperatures greater than 80°C.

NEDERLANDS : Patina, aan te brengen met een "droog penseel" op behaald smeedijzer : 0,25L met 0,25L speciale verdunner. Niet toepassen bij temperaturen hoger dan 80°C ter voorkoming van kleurvervaging.

ESPAÑOL : Pátinas para aplicar con "pincel seco" sobre hierros forjados pintados : 0,25 L. con 0,25 L de disolvente especial. No exponer a temperaturas superiores a 80°C (Riesgo de decoloración).

RUSSE : Патина для нанесения методом сухой кисти на окрашенную стальную поверхность (смесь 0,25 л с 0,25 л специального растворителя). Окончательная отделка применяется как в помещении (XV1), так и вне помещения (XV2). Цвет краски блекнет при воздействии температур выше 80°C.



Rouille
Rost
Rust
Rost
Rust
Ржавчина

XPA - R



Fer naturel
Eisen natur
Natural iron
Naturel-metaalkleur
Hierro natural
Натуральное железо

XPA - F



Vieux bronze
Alt bronze
Old bronze
Oud brons
Bronce viejo
Состаренная бронза

XPA - B



Vert de gris
Verdigris
Grünspan
Kopergroen
Color verdin
Ярь-медянка

XPA - V

FRANÇAIS : XNO 3 et XME 3 sont des peintures à base de Polyvinyle (plastique liquide) d'aspect satiné à séchage rapide. Leur qualité d'adhérence est exceptionnelle. Elles s'appliquent directement au pinceau ou au pistolet sans sous-couche, sur surfaces fraîchement zinguées, aluminium ou cuivre. Particulièrement adaptées aux pièces forgées, les reliefs tels que les rainures ou gravures ne seront pas noyées. XNO 3 et XME 3 sont disponibles en NOIR satiné et en GRIS métallisé et conditionnés en cartons scellés de 2,5 L de peinture et 2 L de diluant. Pour une protection anticorrosion durable, les supports en acier brut (non zingués) seront débarrassés de toutes souillures, anciennes peintures, graisses, calamine, rouille, par brossage ou de préférence par grenailage et revêtus d'une sous-couche type XP 300. Ne pas soumettre les ouvrages peints avec XME3 ou XNO3 à une température supérieure à 110°C.

DEUTSCH : XNO 3 / XME 3 ist eine Kunstharzlackfarbe auf Basis Polyvinylmischpolymerisat (Flüssigkunststoff) Seidenmatt, schnelltrocknend und kann mit Pinsel, Rolle oder Spritzpistole aufgetragen werden. Ohne Grundierung werden festhaftende, wetterbeständige Anstriche auf frisch verzinkte Eisenflächen erreicht. XNO 3/XME 3 eignen sich insbesondere für Schmiedestücke, weil z. B. Hammerschläge und Gravuren nicht überdeckt werden. Lieferbar in SATINSCHWARZ oder EISENGLIMMER (Graumetallic), nur in verschweißten Kartons : 2,5 L Lack und 2 L Verdünnung. Bei hohen Ansprüchen hinsichtlich Korrosionsschutz auf Eisen und Stahluntergründen empfiehlt sich ein Grundanstrich mit unserer Grundierfarbe XP 300. Die mit XME3 oder XNO3 gestrichenen Werkstücke nicht einer Temperatur höher als 110°C aussetzen.

ENGLISH : XNO 3 and XME 3 are Polyvinyl base paints (liquid plastic), satin looking, rapid drying, excellent adhesive and chip resistant. Application by brush or spray directly without pre-treatment on freshly hot dipped galvanized iron work. Especially suitable for forged iron, as the reliefs of the hammering and engraving are not sunken. Available in Satin BLACK or METALLIC-GREY. Packaging : Cardboard box containing 2.5 L paint and 2 L thinner. To achieve anti corrosion status a base undercoat XP 300 must first be applied to untreated steelwork prior to using XNO 3 and XME 3. Items painted with XME3 or XNO3 should not be exposed to temperatures greater than 110°C.

ESPAÑOL : XNO 3 y XME 3 son pinturas a base de polivinilo (plástico líquido) de aspecto satinado y secado rápido. Sus cualidades de adherencia son excepcionales. Se aplican directamente a brocha o pistola sin tratamiento previo sobre superficies de acero galvanizadas en caliente ó aluminio. Particularmente estudiadas para piezas de forja, puesto que mantiene el relieve de las ranuras ó grabados. Disponible en NEGRO satinado y en GRIS metalizado. Únicamente en recipientes de 2.5 L de pintura y 2 L de disolvente. Para una eficaz protección anticorrosiva, los soportes de acero no zincados serán limpiados de impurezas, restos de pintura vieja, grasa, calamina, óxido, cepillando o preferentemente por chorro de arena y revestidos de una base tipo XP 300. No someter los trabajos pintados con XME3 ó XNO3 a temperaturas superiores a 110°C.

RUSSE : Продукты XNO 3 и XME 3 – это поливиниловые краски (жидкий пластик), с глянцевым блеском, быстросохнущие, с высокой связующей способностью и стойкие к

шелушению. Наносятся при помощи кисти или распылителя непосредственно на металлическое изделие, сразу после оцинковки горячим способом, без предварительной обработки. Особо подходит для кованого железа, поскольку ковка и чеканка не оставляют углублений. Имеющиеся варианты: Satin BLACK (глянцевый черный) или METALLIC-GREY (серый металл). Фасовка: картонная



NOIR - SCHWARZ
BLACK - ZWART
NEGRO - ЧЁРНЫЙ

GRIS MÉTAL - EISENGLIMMER
METAL GREY - METAALGLANS
GRIS METALIZADO - СЕРЫЙ
МЕТАЛЛИК

XNO 3

XME 3

FRANÇAIS : Le primaire XP 300 est une **peinture antirouille** à séchage rapide aux phosphates de zinc à base de résines alkydes. Ses excellentes propriétés antirouille résultent des proportions optimales entre le diluant et les extraits secs, ainsi que de l'utilisation de phosphates de zinc comme pigments inhibiteurs de corrosion. XP 300 adhère particulièrement bien aux surfaces en fer, acier ou fonte et constitue un excellent primaire pour la plupart des finitions. Résiste aux intempéries. Pour diluer, nous recommandons un diluant synthétique. Primaire de couleur gris clair, contenance de 2,5 L et poids de 4,2 kg.

DEUTSCH : Die GRUNDIERFARBE XP 300 ist eine schnelltrocknende, **antikorrosive Grundierfarbe** auf Alkydharzbasis. Die sehr guten Korrosionsschutzeigenschaften resultieren aus einem optimalen Verhältnis zwischen Bindemittel und Festkörper, sowie durch die Verwendung von Zinkphosphat als aktives Rostschutzpigment gegen Unterrostung. Die GRUNDIERFARBE XP 300 besitzt sehr gute Haftungseigenschaften auf Eisen, Stahl und Gußeisen. Die GRUNDIERFARBE XP 300 vermittelt der nachfolgenden Lackierung eine optimale Haftfestigkeit und Wetterbeständigkeit. Zum Verdünnen empfehlen wir eine Kunstharzverdünnung. Hellgraue Grundierfarbe, 2,5 L Inhalt und 4,2 Kg Gewicht.

ENGLISH : XP 300 is a fast drying high build zinc phosphate **primer** which offers maximum anti-corrosion when applied to iron, steel and cast. It is

particularly effective in severe weather conditions with the zinc phosphate providing maximum prevention against rust. When using XP 300 we recommend the use of a synthetic thinner for thinning purposes. Light grey primer, 2,5 L (weight each: 4,2 kg).

RUSSE : Продукт XP 300 – быстросохнущая с высоким содержанием сухого остатка цинк-фосфатная грунтовка, обеспечивающая максимальный антикоррозионный эффект при нанесении на железо, сталь или чугун. Особенно эффективна в суровых погодных условиях, поскольку фосфат цинка обеспечивает максимальную защиту от ржавчины. При применении продукта XP 300, для разбавления рекомендуется использовать синтетический растворитель. Светло-серая грунтовка, 2,5 л (вес каждой упаковки – 4,2 кг).

ESPAÑOL : La imprimación XP 300 es una **pintura antióxido** de secado rápido con Fosfatos de Zinc a base de resinas acrílicas. Sus excelentes propiedades antióxido resultan de la óptima proporción entre el disolvente y los extractos secos, así como de la utilización de Fosfatos de Zinc como pigmentos inhibidores de la corrosión. XP 300 se adhiere especialmente bien en superficies de hierro, acero o fundición y constituye una excelente imprimación para la mayor parte de acabados. Resiste a la intemperie. Recomendamos un disolvente sintético para diluirlo. Pintura de color gris claro. Contenido : 2,5 L y peso 4,2 kg.



XP 300

FRANÇAIS : Vernis acrylique en aérosol. Contenu : 0,40 L. Convient particulièrement pour la protection des pièces en laiton et bronze. Conseillé pour retouches ou petits travaux uniquement. Pour une protection supérieure nous recommandons le vernis XV2.

DEUTSCH : Klarlack Spray - Acryl Basis. Inhalt: 0,40 L. Besonders geeignet für Messing- und Bronzeteile. Nur geeignet für Nachbearbeitungen oder kleinere Teile. Für einen höheren Schutz empfehlen wir den XV2 Lack.

ENGLISH : Transparent lacquer spray, acrylic based. Size : 0,40 liter. Especially suited for brass and bronze items. Use for touchups or small projects only. For greater protection out of doors we recommend XV2 lacquer.

NEDERLANDS : Blanke lak spray - acryl basis. Inhoud : 0,40 ltr. Speciaal bruikbaar voor messing en bronzen componenten. Alleen geschikt voor nabewerking of kleine onderdelen. Voor een betere bescherming wordt de XV2 lak aanbevolen.

ESPAÑOL : Barniz acrílico en aerosol. Contenido : 0,40 L. Adecuado particularmente para la protección de piezas de latón o bronce. Aconsejado únicamente para retoques o pequeños trabajos. Para una protección superior, recomendamos el barniz XV2.

RUSSE : Прозрачный акриловый лак-аэрозоль. Объем: 0,40 литра. Особенно подходит для изделий из меди и бронзы. Используется только для подкраски и небольших работ. Для лее эффективной защиты вне помещения рекомендуется лак XV2.



XV 1

FRANÇAIS : Vernis à base de polyuréthane à 2 composants. Livré en carton contenant 1 litre de vernis avec durcisseur et 1 litre de diluant. Excellent pour la protection des pièces en laiton. Les éléments vernis ne doivent pas être exposés à une température supérieure à 110°C.

DEUTSCH : Zweikomponentenlack auf Polyurethan-Basis. Lieferbar im geschlossenen Karton. Inhalt: 1 Liter Lack mit Härter und 1 Liter Verdünnung. Besonders zum Schutz von Messingteilen geeignet. Die lackierten Teile dürfen nicht einer Temperatur höher als 110°C ausgesetzt werden.

ENGLISH : Polyurethane based lacquer. Supplied complete with 1 litre of lacquer, hardener and thinner. Excellent for the protection of brass items. Lacquered items should not be exposed to temperatures greater than 110°C.

NEDERLANDS : Twee componenten, Polyurethaan blanke basislak, uitsluitend . Leverbaar in gesloten verpakking. Inhoud : 1 ltr. lak met verharder, 1 ltr. verdunner. Speciaal bruikbaar voor messing componenten. De gelakte delen niet blootstellen aan een temperatuur hoger dan 110°C.

ESPAÑOL : Barniz Poliuretano dos componentes. Suministrado en caja de cartón conteniendo 1L. de Barniz con endurecedor y 1L. de disolvente. Excelente para la protección de piezas de latón. Los elementos barnizados no deben ser expuestos a temperaturas superiores a 110°C.

RUSSE : Полиуретановый лак. Поставляется в комплекте: 1 литр лака, отвердитель и растворитель. Идеально подходит для защиты изделий из меди. Лакированные изделия не должны подвергаться воздействию температур выше 110°C.



XV 2

SERRURERIE - TORZUBEHÖR - HARDWARE POORTTOEBEHOREN - CERRAJERIA - ФУРНИТУРА

FRANÇAIS : Pivot et crapaudine - à sceller ou à souder. Réglable latéralement et en hauteur. Prévu pour tube carré. Charge admissible: 1000 Kg.

DEUTSCH : Dekorative Torpfanne - zum Anschweißen oder Einzementieren. Höhe und Breite verstellbar. Lieferung mit dem Zieraufsatz. Tragkraft: 1000 Kg.

ENGLISH : Gate pivot - to weld or to seal. Lateral and height adjustable. Delivered with a ball or a pine cone head.

Load cap.: 1000 Kg (2200 lb).

NEDERLANDS : Decoratief poortdraaipunt, te lassen of in te metselen, hoogte en breedte verstelbaar. Leverbaar met een bol of een granaatappel. Draagkracht: 1000 Kg.

ESPAÑOL : Pivote inferior y agarre superior para empotrar o soldar. Regulable lateralmente y en altura. Incluye la bola o piña. Carga admisible: 1000 Kg.

RUSSE : Закрепляемые или привариваемые стержень и подпятник. Регулировка сбоку и по высоте. Предусмотрены для квадратных труб. Допустимая нагрузка: 1000 кг.



| | | |
|---------|---------|--------|
| ∅ 30 mm | 1 3/16" | SH 242 |
| ∅ 40 mm | 1 9/16" | SH 244 |

| | | |
|---------|---------|--------|
| ∅ 30 mm | 1 3/16" | SH 243 |
| ∅ 40 mm | 1 9/16" | SH 245 |



FRANÇAIS : Crapaudine
DEUTSCH : Spurlager
ENGLISH : Hinge bearing
NEDERLANDS :
ESPAÑOL : Tetón giratorio
RUSSE : Подпятник

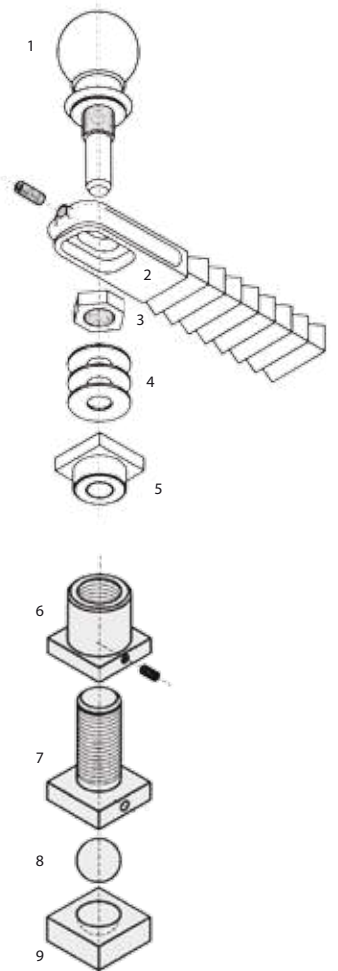

| | | |
|-------|---------|---------|
| SH 42 | ∅ 30 mm | 1000 Kg |
| | 1 3/16" | 2204 lb |
| SH 44 | ∅ 40 mm | 1000 Kg |
| | 1 9/16" | 2204 lb |

| | | |
|-------|---------|---------|
| SH 43 | ∅ 30 mm | 1000 Kg |
| | 1 3/16" | 2204 lb |
| SH 45 | ∅ 40 mm | 1000 Kg |
| | 1 9/16" | 2204 lb |

| | | |
|--------|---------|---------|
| SH 142 | ∅ 30 mm | 1000 Kg |
| | 1 3/16" | 2204 lb |
| SH 144 | ∅ 40 mm | 1000 Kg |
| | 1 9/16" | 2204 lb |

FRANÇAIS : Arrêteur de portail, zingué, avec ressort en acier inoxydable.

DEUTSCH : Torfeststeller, Feuerverzinkt mit Edelstahlfeder.

ENGLISH : Swing gate stop, galvanized, with a stainless steel spring.

NEDERLANDS : Poortvastzetter verzinkt, met RVS veer.

ESPAÑOL : Tope para puerta zincado con resorte de acero inoxidable.

RUSSE : Оцинкованная защёлка для фиксации створок ворот с пружиной из нержавеющей стали.

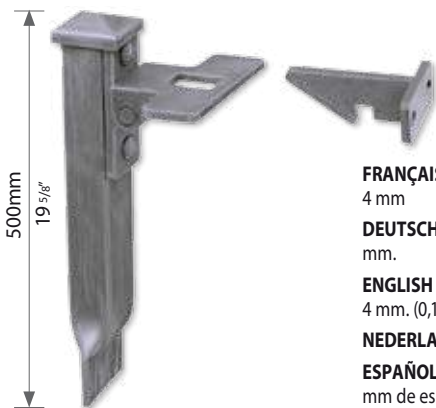

AR 6

FRANÇAIS : Bande découpée en tôle brute, ép. 3 mm, à souder.

DEUTSCH : Zackenleisten aus rohem Blech, 3 mm dick, zum Anschweißen.

ENGLISH : Punched strip steel, thickness 3 mm, rough, to be welded.

NEDERLANDS : Puntkammen, blank ijzer, 3 mm. dik.

ESPAÑOL : Banda cortada en chapa de hierro de 3 mm para soldar.

RUSSE : Перфорированная стальная полоса толщиной 3 мм, необработанная, можно приваривать.

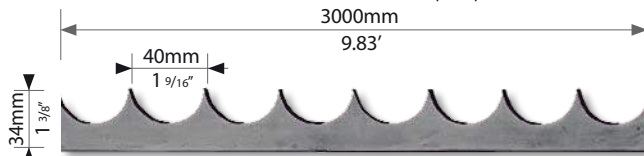

LA 300

FRANÇAIS : Butée de portail en tôle brute ép. 4 mm

DEUTSCH : Auflaufstütze roh, Blechstärke 4 mm.

ENGLISH : Centre stop plate rough sheet metal 4 mm. (0,15")

NEDERLANDS : Poortaanslag, plaatdikte 4 mm.

ESPAÑOL : Tope de puerta, chapa en bruto de 4 mm de espesor.

RUSSE : Центральный упор из необработанной листовой стали толщиной 4 мм.

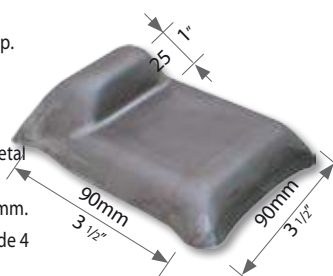

BF 20

Verrou de portail à souder.

Bolzen-Stangenriegel, roh, zum Anschweißen.

Gate bolt, fully weldable.

Aanlas poortgrendel, onbehandeld.

Pasador de cierra para puerta.

Para soldar a la puerta.

Регулируемая петля

с шаровой опорой.

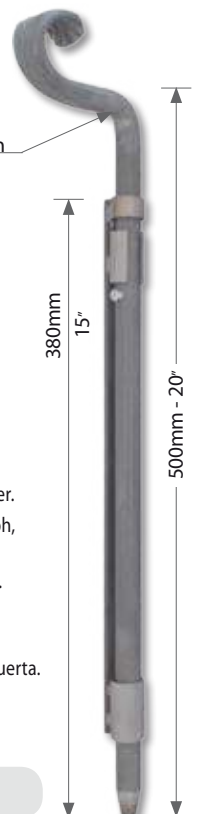

SEV 50

SERRURERIE - TORZUBEHÖR - HARDWARE POORTTOEBEHOREN - CERRAJERIA - ФУРНИТУРА

FRANÇAIS : Pivot
DEUTSCH : Torband
ENGLISH : Hinge
ESPAÑOL : Pivote
RUSSE : стержень

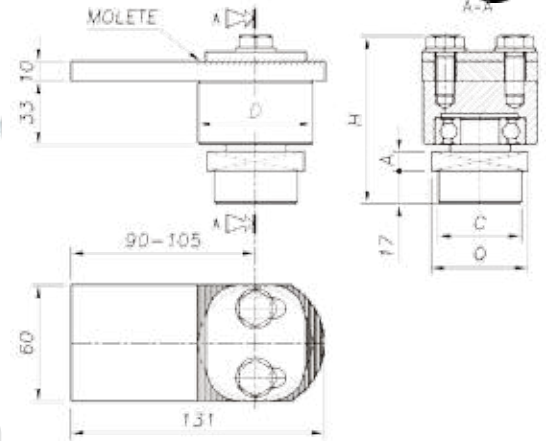

| | A | ØC | ØD | H | ØQ | KG | KG |
|----------------|---------------|-------------------|---------------------|------------------|-------------------|------------------|------------------|
| SE88-40 | 10 mm 3/8" | 33 mm 1 5/8" | Ø 60 mm Ø 2 3/8" | 87mm 3 7/16" | 40 mm 1 9/16" | 1,6 Kg 3.5 lb | 200 Kg 441 lb |
| SE88-50 | 10 mm 3/8" | 43 mm 1 11/16" | Ø 60 mm Ø 2 3/8" | 87 mm 3 7/16" | 50 mm 1 15/16" | 1,7 Kg 3.7 lb | 400 Kg 882 lb |

FRANÇAIS : Crapaudine
DEUTSCH : Spurlager
ENGLISH : Hinge bearing
ESPAÑOL : Tetón giratorio
RUSSE : подпятник

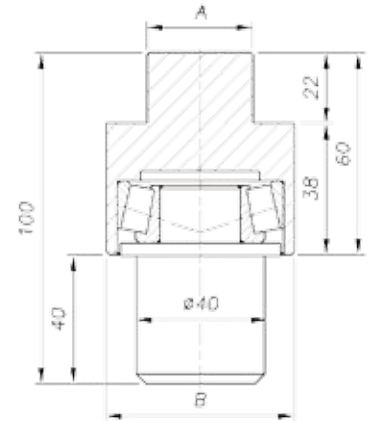

| | ØA | ØB | KG | KG |
|----------------|-------------------|---------------------|------------------|------------------|
| SE89-40 | 40 mm 1 9/16" | Ø 60 mm Ø 2 3/8" | 1,2 Kg 2.6 lb | 200 Kg 441 lb |
| SE89-50 | 50 mm 1 15/16" | Ø 60 mm Ø 2 3/8" | 1,4 Kg 3 lb | 400 Kg 882 lb |

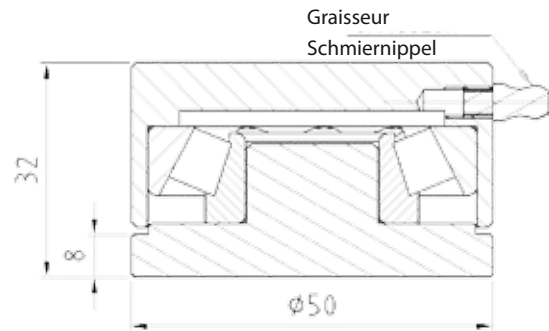

| | KG | KG |
|--------------|-----------------|------------------|
| SE87M | 0.45 Kg 1 lb | 450 Kg 990 lb |

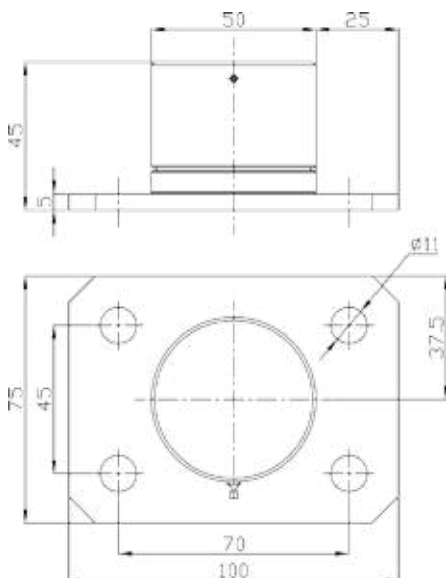

FRANÇAIS : Crapaudine avec roulement de butée et platine à visser.
DEUTSCH : Unteres Torband mit Drucklager und Platte zum Anschrauben.
ENGLISH : Thrust bearing with mounting plate to be screwed.
ESPAÑOL : Tetón con rodamiento de tope y pletina para atornillar.
RUSSE : подшипник и платина



| | KG | KG |
|----------------|------------------|------------------|
| SE87PST | 0.6 Kg 1.3 lb | 450 Kg 990 lb |

SERRURERIE - TORZUBEHÖR - HARDWARE



FRANÇAIS: Gond avec ailes pour ouverture à 180°.
DEUTSCH: Torband mit Laschen für 180° Öffnung.
ENGLISH: Adjustable hinge with weld tabs. 180° swing.
NEDERLANDS: Schanier met vleugels tot 180° te openen.
ESPAÑOL: Gozne con alas para apertura de 180°.
RUSSE: Регулируемый шарнир со сварными лапками.
 Поворот на 180°

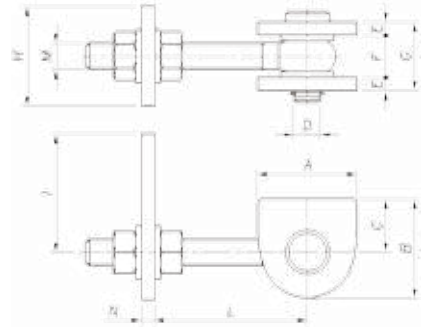

| | A | B | C | ØD | E | F | G | H | I | L | M | N | KG |
|--------------|-------------------|------------------|--------------------|---------------------|---------------|------------------|-------------------|-----------------|---------------------------------|---------------------------------|-----------------|---------------|------------------|
| SH 12 | 45 mm 1 3/4" | 45 mm 1 3/4" | 24 mm 1 5/16" | Ø 12 mm Ø 1/2" | 6 mm 1/4" | 19 mm 1 1/4" | 31 mm 1 1/4" | 45 mm 1 3/4" | 47 - 60 mm 7/8"-2 3/8" | 35 - 82 mm 1 7/16"-3 1/4" | 12 mm 1/2" | 6 mm 1/4" | 50 Kg 110 lb |
| SH 26 | 50 mm 1 15/16" | 50,5 mm 2" | 27,5 mm 1 1/16" | Ø 16 mm Ø 5/8" | 6 mm 1/4" | 23 mm 7/8" | 35 mm 1 3/8" | 60 mm 2 3/8" | 53,5 - 69,5 mm 2 1/8"-2 3/4" | 41 - 97 mm 1 5/8"-3 13/16" | 16 mm 5/8" | 8 mm 5/16" | 75 Kg 165 lb |
| SH 28 | 69 mm 2 3/4" | 65 mm 2 9/16" | 35 mm 1 3/8" | Ø 18 mm Ø 11/16" | 8 mm 5/16" | 28 mm 1 1/8" | 44 mm 1 3/4" | 60 mm 2 3/8" | 72 - 107 mm 2 13/16"-4 3/16" | 53,5-103,5 mm 2 1/8"-4 1/16" | 20 mm 13/16" | 8 mm 5/16" | 125 Kg 275 lb |
| SH 24 | 69 mm 2 3/4" | 65 mm 2 9/16" | 35 mm 1 3/8" | Ø 22 mm Ø 7/8" | 8 mm 5/16" | 34 mm 1 5/16" | 50 mm 1 15/16" | 70 mm 2 3/4" | 88 - 110 mm 3 7/16"-4 5/16" | 56,5 - 114 mm 2 1/4"-4 1/2" | 24 mm 15/16" | 12 mm 1/2" | 200 Kg 440 lb |



FRANÇAIS: Gond à souder réglable sans démontage.
DEUTSCH: Verstellbares Band zum Anschweißen.
ENGLISH: Adjustable Hinge - to weld.
NEDERLANDS: Nastelbare aanslanscharnier.
ESPAÑOL: Perno regulable con posibilidad de ser soldado.
RUSSE: Регулируемый шарнир - для сварки

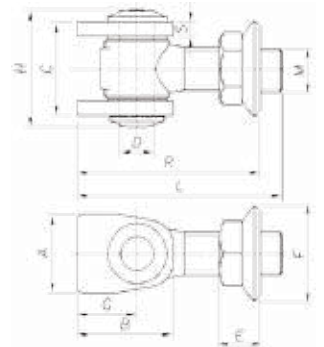

| | A | B | C | ØD | E | ØF | G | H | L | M | R | S | KG |
|--------------|------------------|------------------|------------------|----------------------|-----------------|----------------------|------------------|-----------------|-------------------|--------------|-----------------------------|---------------|------------------|
| SH 18 | 33 mm 1 5/16" | 40 mm 1 9/16" | 39 mm 1 9/16" | Ø 14,5 mm Ø 9/16" | 17 mm 11/16" | Ø 40 mm Ø 1 9/16" | 25 mm 1" | 49 mm 2" | 85,5 mm 3 3/8" | 18 11/16" | 45 - 70 mm 1 3/4"-2 3/4" | 6 mm 1/4" | 125 Kg 275 lb |
| SH 22 | 40 mm 1 9/16" | 47 mm 1 7/8" | 53 mm 2 1/8" | Ø 20 mm Ø 13/16" | 20 mm 13/16" | Ø 49 mm Ø 2" | 27 mm 1 1/16" | 64 mm 2 1/2" | 95,5 mm 3 3/4" | 22 7/8" | 70 - 95 mm 2 3/4"-3 3/4" | 8 mm 5/16" | 190 Kg 418 lb |

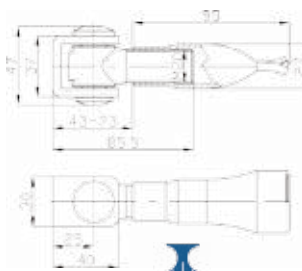

SH 125-20 150 Kg
330 lb

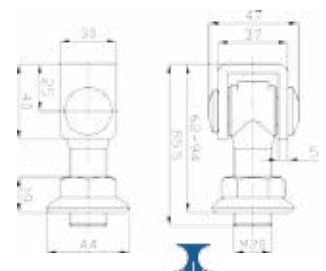

SH 155-20 150 Kg
330 lb

FRANÇAIS: Gond réglable avec platine et butée à billes.
DEUTSCH: Torband und Wandplatte, verstellbar, mit Radialkugellager.
ENGLISH: Adjustable hinge with bearing and mounting plate.
NEDERLANDS: Verstelbaar schanier met lager en montageplaat
ESPAÑOL: Gozne regulable con pletina y cojinete de bolas.
RUSSE: Регулируемый шарнир с подшипником и монтажной панелью

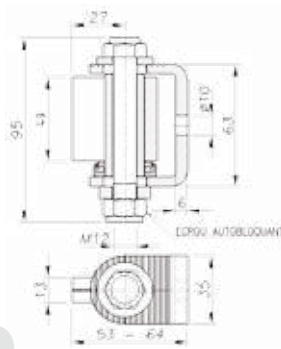

SH 50 300 Kg
660 lb



FRANÇAIS: Gond réglable à douille.
DEUTSCH: Torband mit U-Bügel und Gewindebuchse.
ENGLISH: Hinge for bushing.
ESPAÑOL: Gozne regulable con casquillo.
RUSSE: Шарнир для втулки

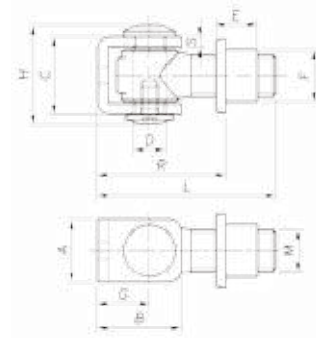

| | A | B | C | ØD | E | ØF | G | H | L | M | R | S | KG |
|-----------------|------------------|------------------|-----------------|-----------------------|-----------------|---------------------|------------------|-----------------|----------------------|--------------|-----------------------------|---------------|------------------|
| SE120-20 | 30 mm 1 3/16" | 40 mm 1 9/16" | 37 mm 1 3/8" | Ø 14,5 mm Ø 9/16" | 20 mm 13/16" | Ø 25 mm Ø 1" | 25 mm 1" | 47 mm 1 7/8" | 85 mm 3 3/8" | 20 13/16" | 45 - 70 mm 1 3/4"-2 3/4" | 5 mm 3/16" | 150 Kg 330 lb |
| SE120-24 | 35 mm 1 3/8" | 45 mm 1 3/4" | 49 mm 2" | Ø 19,5 mm Ø 13/16" | 26 mm 1" | Ø 29 mm Ø 1 1/8" | 27 mm 1 1/16" | 59 mm 2 3/8" | 100,5 mm 3 15/16" | 24 15/16" | 55 - 75 mm 2 1/8"-3" | 6 mm 1/4" | 225 Kg 495 lb |



FRANÇAIS: Gond à souder réglable sans démontage.
DEUTSCH: Verstellbares Band zum Anschweißen.
ENGLISH: Adjustable Hinge - to weld.
NEDERLANDS: Nastelbare aanlasscharnier.
ESPAÑOL: Perno regulable con posibilidad de ser soldado.
RUSSE: Регулируемый шарнир - для сварки

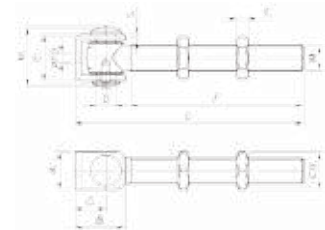

| | A | B | C | ØD | E | F | G | H | L | M | CH | S | KG |
|-----------------|------------------|------------------|-----------------|-----------------------|----------------|-------------------|------------------|-----------------|--------------------|--------------|------------------|---------------|------------------|
| SE130-20 | 30 mm 1 3/16" | 40 mm 1 9/16" | 37 mm 1 3/8" | Ø 14,5 mm Ø 9/16" | 9 mm 5/16" | 138 mm 5 5/16" | 25 mm 1" | 47 mm 1 7/8" | 182,5 mm 7 1/4" | 20 13/16" | 30 mm 1 3/16" | 5 mm 3/16" | 150 Kg 330 lb |
| SE130-24 | 35 mm 1 3/8" | 45 mm 1 3/4" | 49 mm 2" | Ø 19,5 mm Ø 13/16" | 10 mm 5/16" | 138 mm 5 5/16" | 27 mm 1 1/16" | 59 mm 2 3/8" | 187,5 mm 7 1/4" | 24 15/16" | 36 mm 1 3/8" | 6 mm 1/4" | 225 Kg 495 lb |

FRANÇAIS: Gond réglable avec platine et butée à billes.
DEUTSCH: Torband mit Lasche, Kugellager und Anschraubplatte.
ENGLISH: Adjustable hinge with bearing and mounting plate.
ESPAÑOL: Gozne regulable con pletina y tope de rodamiento.
RUSSE: Регулируемый шарнир с подшипником и монтажной панелью

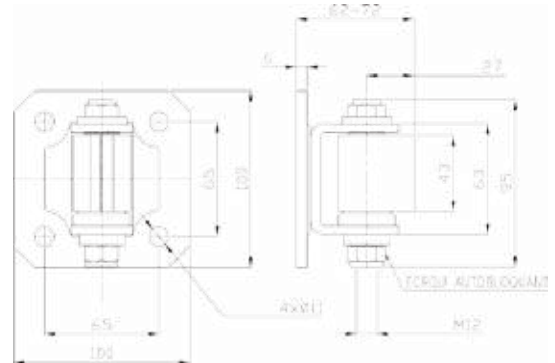

SE96 300 Kg
660 lb

FRANÇAIS: Gond réglable avec platine et butée à billes.
DEUTSCH: Torband mit Lasche, Kugellager und Anschraubplatte.
ENGLISH: Adjustable hinge with bearing and mounting plate.
ESPAÑOL: Gozne regulable con pletina y tope de rodamiento.
RUSSE: Регулируемый шарнир с подшипником и монтажной панелью

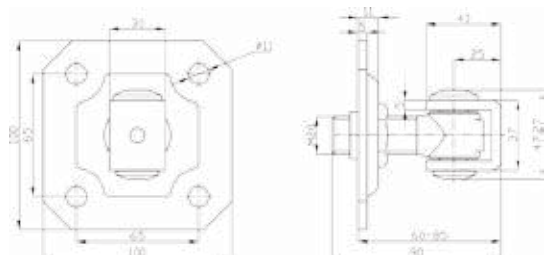

SE161-20 150 Kg
330 lb

SERRURERIE - TORZUBEHÖR - HARDWARE POORTTOEBEHOREN - CERRAJERIA - ФУРНИТУРА

FRANÇAIS : Paumelles décoratives, en fer, à souder ou à sceller. Pivot avec butée à billes.

NEDERLANDS : Decoratieve ijzeren scharnieren met kogellager.

RUSSE : Декоративный шарнир с шарикоподшипником

DEUTSCH : SH11-31: Torband zum Anschweißen.
SH112-32 - Verstellbares Torband mit Anschweißmutter.
SH13-33 - Verstellbares Torband mit Mauerhülse.

ENGLISH : Decorative barrel hinge with ball bearing.

ESPAÑOL : Pernios decorativas en hierro para soldar o sellar. Pivote con tope de rodamiento.



| | A | B | ØC | D | KG |
|--------------|--------------------|--------------------|----------------------|---------------|------------------|
| SH 11 | 108 mm 4 1/4" | 30,5 mm 1 3/16" | Ø 22 mm Ø 7/8" | 6 mm 1/4" | 75 Kg 165 lb |
| SH 31 | 170 mm 6 11/16" | 43 mm 1 11/16" | Ø 30 mm Ø 1 3/16" | 12 mm 1/2" | 300 Kg 660 lb |

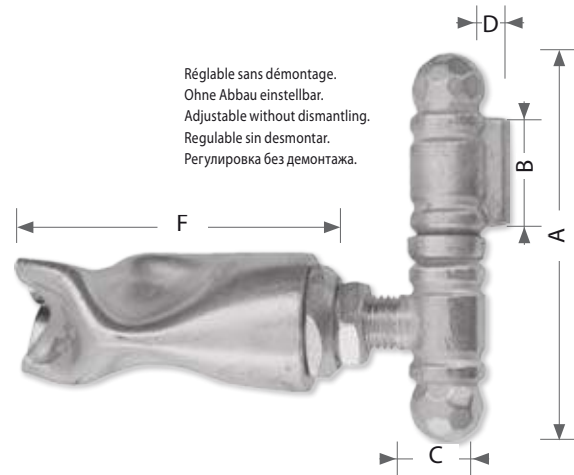

Réglable sans démontage.
Ohne Abbau einstellbar.
Adjustable without dismantling.
Regulable sin desmontar.
Регулировка без демонтажа.

| | A | B | ØC | D | F | KG |
|--------------|--------------------|--------------------|----------------------|---------------|--------------------|------------------|
| SH 13 | 108 mm 4 1/4" | 30,5 mm 1 3/16" | Ø 22 mm Ø 7/8" | 6 mm 1/4" | 100 mm 3 15/16" | 75 Kg 165 lb |
| SH 33 | 170 mm 6 11/16" | 43 mm 1 11/16" | Ø 30 mm Ø 1 3/16" | 12 mm 1/2" | 135 mm 5 5/16" | 300 Kg 660 lb |

FRANÇAIS : Gond réglable avec roulement à billes. Charge pour 2 paumelles : 600 kg.
DEUTSCH : Torband, verstellbar, mit Kugellager. Tragkraft : 2 Bänder 600 kg.
ENGLISH : Adjustable hinge with a ball bearing. Load cap. for 2 hinges : 600 kg (1300 lb).
NEDERLANDS : Poortscharnier, verstelbaar, met kogellagers. Draagkracht : 2 scharnieren, 600 kg.
ESPAÑOL : Gozne regulable con rodamiento a bolas. Carga para dos piezas: 600 kg
RUSSE : Регулируемый петельный крюк с шарикоподшипником. Нагрузка для 2 петель: 600 кг.



SH 35 300 Kg
660 lb

FRANÇAIS : Platinas en acier forgé - ép. 8 mm.

DEUTSCH : Geschmiedete Anschraubplatte aus Stahl - 8 mm dick.

ENGLISH : Forged steel plate, 8 mm thick (5/16").

NEDERLANDS : Gesmede muurplaten uit staal, dikte 8mm.

ESPAÑOL : Pletinas en acero forjado. Espesor: 8 mm.

RUSSE : Пластины из кованой стали (толщина: 8 мм).

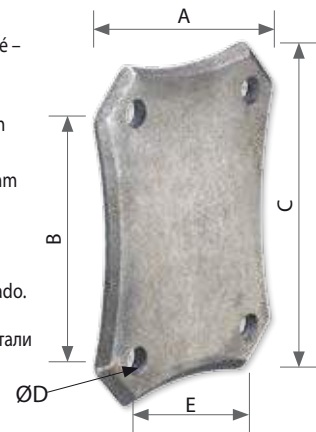

| | A | B | C | ØD | E |
|--------------|---------------------|--------------------|------------------|--------------------|------------------|
| SH 10 | 71,5 mm 2 13/16" | 60 mm 2 3/8" | 90 mm 3 9/16" | Ø 6,5 mm Ø 1/4" | 40 mm 1 9/16" |
| SH 30 | 110 mm 4 5/16" | 100 mm 3 15/16" | 140 mm 5 1/2" | Ø 11 mm Ø 7/16" | 70 mm 2 3/4" |

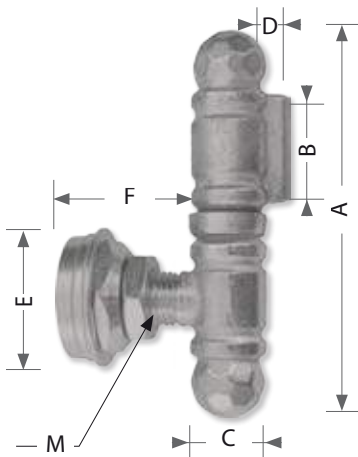

FRANÇAIS : Paumelle décorative en fer à visser. Réglable sans démontage.

DEUTSCH : inkelbänder mit Wandplatte. Ohne Abbau einstellbar.

ENGLISH : Decorative barrel hinge and plate with ball bearing to be screwed. Adjustable without dismantling.

NEDERLANDS : Decoratieve ijzeren scharnieren met plaat een kogellager. Verstelbaar zonder demontage.

ESPAÑOL : Pernios decorativas en hierro para atornillar. Regulable sin desmontar.

RUSSE : Регулируемый петельный крюк с шарикоподшипником

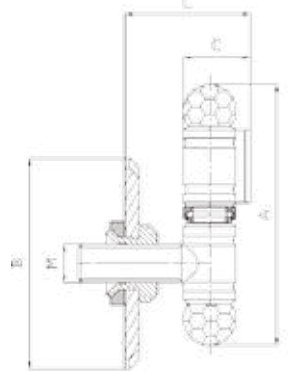

| | A | B | ØC | D | ØE | F | M | KG |
|---------------|--------------------|--------------------|----------------------|---------------|----------------------|-------------------|------|------------------|
| SH 112 | 108 mm 4 1/4" | 30,5 mm 1 3/16" | Ø 22 mm Ø 7/8" | 6 mm 1/4" | Ø 40 mm Ø 1 9/16" | 43 mm 1 11/16" | M 16 | 75 Kg 165 lb |
| SH 32 | 170 mm 6 11/16" | 43 mm 1 11/16" | Ø 30 mm Ø 1 3/16" | 12 mm 1/2" | Ø 50 mm Ø 2" | 66 mm 2 5/8" | M 22 | 300 Kg 660 lb |

| | A | B | C | M | L | KG |
|--------------|-------------------|------------------|-----------------|-----|---------------------------------|------------------|
| SH 14 | 110 mm 4 5/16" | 90 mm 3 9/16" | 28 mm 1 1/8" | M16 | 43,5-64 mm 1 11/16" - 2 1/2" | 75 Kg 165 lb |
| SH 34 | 158 mm 6 1/4" | 140 mm 5 1/2" | 41 mm 1 5/8" | M22 | 66-88 mm 2 5/5" - 3 7/16" | 300 Kg 660 lb |

SERRURERIE - TORZUBEHÖR - HARDWARE POORTTOEBEHOREN - CERRAJERIA - ФУРНИТУРА

FRANÇAIS : Charnières lourdes, à souder – pivot Ø 20 mm avec rondelle laitonée.

DEUTSCH : Schwere Torbänder, zum Anschweißen – Kegel Ø 20 mm mit vermessingtem Ring.

ENGLISH : Weldable heavy hinges. Pivot Ø 20 mm with a brass-plated washer.

NEDERLANDS : Zware poortscharnieren, voor aanlassen - Stift Ø20mm met messing ring.

ESPAÑOL : Pernios fuertes para soldar. Pivote de Ø 20 mm. con arandela latonada.

RUSSE : Привариваемые тяжёлые шарнирные узлы (стержень 20 мм с шайбой, покрытой слоем латуни).



SH 20 50 Kg
110 lb

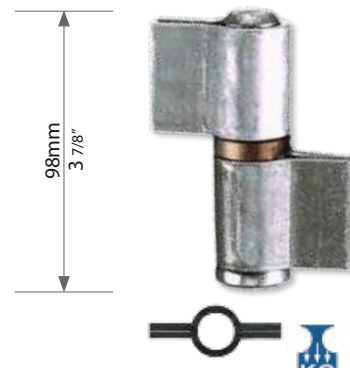

SH 21 75 Kg
165 lb



FRANÇAIS: Gond équipé d'une butée à bille pour ouverture à 180°.

DEUTSCH: Torband mit U- Bügel für 180° Öffnung.

ENGLISH : Hinge for 180° swing with bearing.

ESPAÑOL : Gozne equipado de tope de rodamiento.

RUSSE : Петельный крюк с выступающими кромками для открытия на 180°.

SE 174 75 Kg
165 lb

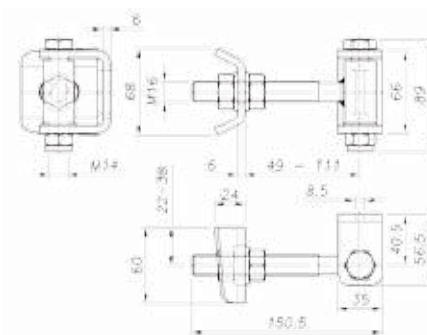

FRANÇAIS: Gond double corps pour ouverture à 180°.

DEUTSCH: Torband mit Doppelgewinde und U-Bügel für 180° Öffnung.

ENGLISH : Hinge for 180° swing.

ESPAÑOL : Gozne de doble cuerpo para apertura de 180°.

RUSSE : Петельный крюк с выступающими кромками для открытия на 180°.

SE 176 150 Kg
330 lb

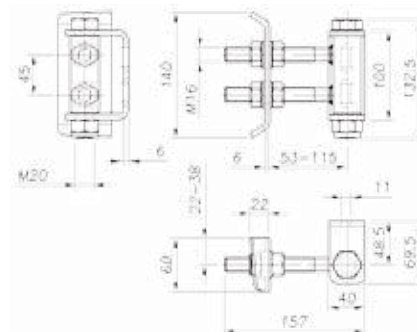

FRANÇAIS : Paumelle goutte usinée avec pivot en acier et butée à bille.

DEUTSCH : Tropfenband mit Stahlstift.

ENGLISH : Barrel hinge with ball bearing.

ESPAÑOL : Pernio de gota fabricado con pivote de acero y tope de rodamiento.

RUSSE : Шарнирный шарнир с шариковым подшипником

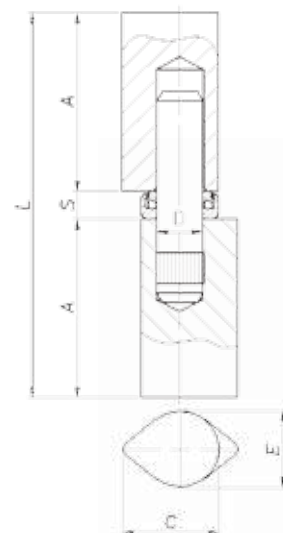

| | A | C | E | ØD | L | S | |
|------------------|-----------------|-----------------|-----------------|-------------------|--------------------|---------------|------------------|
| SE564-100 | 48 mm 2" | 20 mm 13/16" | 16 mm 5/8" | Ø 9 mm Ø 5/16" | 102 mm 3 15/16" | 6 mm 1/4" | 50 Kg 110 lb |
| SE564-120 | 58 mm 2 3/8" | 20 mm 13/16" | 16 mm 5/8" | Ø 9 mm Ø 5/16" | 122 mm 4 3/4" | 6 mm 1/4" | 75 Kg 165 lb |
| SE564-140 | 68 mm 2 3/4" | 25 mm 1" | 20 mm 13/16" | Ø 12 mm Ø 1/2" | 143 mm 5 11/16" | 7 mm 5/16" | 90 Kg 200 lb |
| SE564-160 | 77 mm 3" | 25 mm 1" | 20 mm 13/16" | Ø 12 mm Ø 1/2" | 161 mm 6 5/16" | 7 mm 5/16" | 100 Kg 220 lb |

SERRURERIE - TORZUBEHÖR - HARDWARE POORTTOEBEHOREN - CERRAJERIA - ФУРНИТУРА



FRANÇAIS: Paumelle "serrurier" réglable sans démontage avec douille à souder.
DEUTSCH: Halseisenband mit Anschweißbuchse verstellbar.
ENGLISH: Adjustable hinge with bushing to be welded.
ESPAÑOL: Pernio de cerrajero regulable sin desmontar con casquillo para soldar.
RUSSE: Регулируемый шарнир с втулкой для сварки

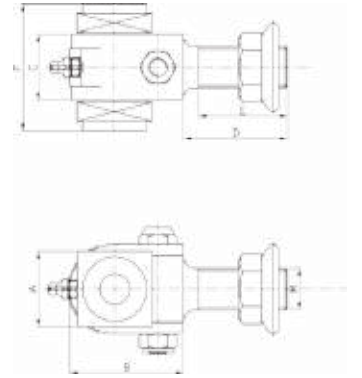

| | A | B | C | D | E | F | M | |
|-----------------|------------------------------------|-----------------|------------------|-------------------|-----------------|-----------------|------|------------------|
| SE182-30 | 30 mm x 30 mm 1 3/16" x 1 3/16" | 56 mm 2 1/8" | 30 mm 1 3/16" | 50 mm 1 15/16" | 35 mm 1 3/8" | 62 mm 2 3/8" | M 18 | 100 Kg 220 lb |
| SE182-40 | 40 mm x 40 mm 1 9/16" x 1 9/16" | 60 mm 2 3/8" | 35 mm 1 3/8" | 62 mm 2 3/8" | 47 mm 1 7/8" | 67 mm 2 5/8" | M 22 | 160 Kg 350 lb |

FRANÇAIS: Paumelles "serrurier" pour tube 30 et 40. À sceller.
DEUTSCH: Halseisenband mit Schmiernippel und Mauerhülse.
ENGLISH: 30 and 40 square tube hinge for concrete setting.
ESPAÑOL: Pernio de cerrajero para tubo de 30 o 40. Para sellar.
RUSSE: 30 и 40 квадратных труб петли для укладки бетона

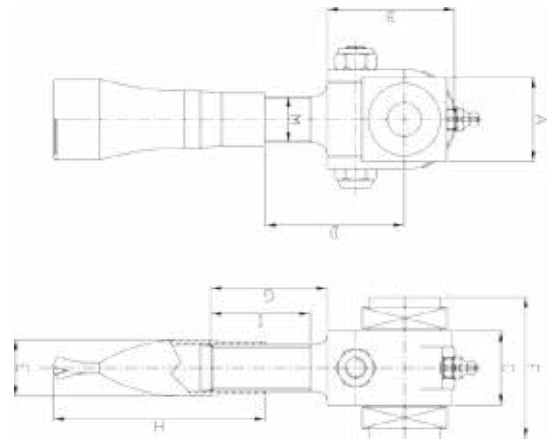

| | A | B | C | D | ØE | F | G | H | I | M | |
|-----------------|------------------------------------|-----------------|------------------|------------------------------|----------------------|-----------------|-------------------|--------------------|-----------------|------|------------------|
| SE184-30 | 30 mm x 30 mm 1 3/16" x 1 3/16" | 56 mm 2 1/8" | 30 mm 1 3/16" | 40-70 mm 1 9/16" - 2 3/4" | Ø 25 mm Ø 1" | 62 mm 2 3/8" | 50 mm 1 15/16" | 100 mm 3 15/16" | 35 mm 1 3/8" | M 18 | 100 Kg 220 lb |
| SE184-40 | 40 mm x 40 mm 1 9/16" x 1 9/16" | 60 mm 2 3/8" | 35 mm 1 3/8" | 45-75 mm 1 3/4" - 3" | Ø 27 mm Ø 1 1/16" | 67 mm 2 5/8" | 55 mm 2 1/4" | 100 mm 3 15/16" | 47 mm 1 7/8" | M 22 | 160 Kg 350 lb |

FRANÇAIS: Paumelle "serrurier" sur platine.
 Réglable sans démontage.
DEUTSCH: Halseisenband mit Schmiernippel und Wandplatte zum Verstellen.
ENGLISH: Hinge with steel mounting plate.
ESPAÑOL: Pernio de cerrajero sobre pletina.
 Regulable sin desmontar.
RUSSE: Регулируемый шарнир с втулкой для сварки

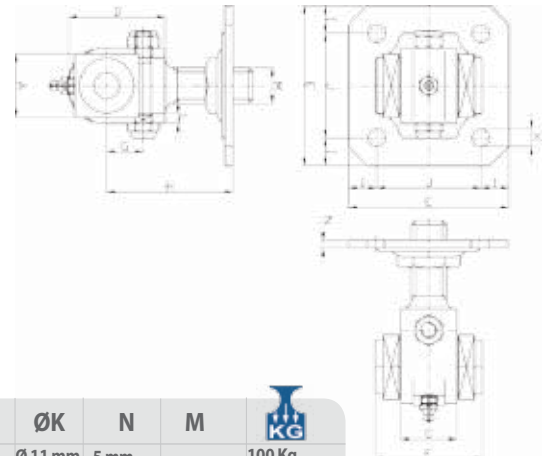
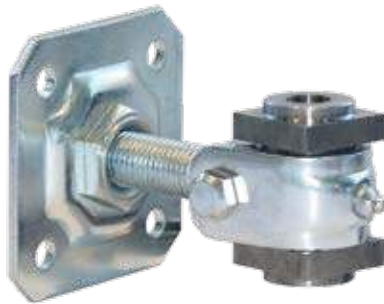

| | A | C | D | E | F | G | H | I | J | ØK | N | M | |
|-----------------|------------------------------------|------------------|-----------------|--------------------|-----------------|---------------|--------------------------------|-------------------|------------------|---------------------|--------------|------|------------------|
| SE186-30 | 30 mm x 30 mm 1 3/16" x 1 3/16" | 30 mm 1 3/16" | 56 mm 2 1/8" | 100 mm 3 15/16" | 62 mm 2 3/8" | 21 mm 7/8" | 55 - 85 mm 2 3/16" - 3 3/8" | 17,5 mm 11/16" | 65 mm 2 9/16" | Ø 11 mm Ø 2 3/4" | 5 mm 1/4" | M 18 | 100 Kg 220 lb |
| SE186-40 | 40 mm x 40 mm 1 9/16" x 1 9/16" | 35 mm 1 3/8" | 60 mm 2 3/8" | 100 mm 3 15/16" | 67 mm 2 5/8" | 23 mm 7/8" | 70 - 90 mm 2 3/4" - 3 9/16" | 17,5 mm 11/16" | 65 mm 2 9/16" | Ø 11 mm Ø 2 3/4" | 5 mm 1/4" | M 22 | 160 Kg 350 lb |

FRANÇAIS : Rails de roulement en acier galvanisé. Longueur: 3000 mm
DEUTSCH : Boden Laufschienen aus Stahl, verzinkt. Länge: 3000 mm.
ENGLISH : Running rails made of galvanized steel. Length : 3000 mm.
ESPAÑOL : Raíles para rodamientos en acero galvanizado. Longitud : 3000 mm.

RUSSE : Ходовые рельсы из оцинкованной стали. Длина: 3000 мм

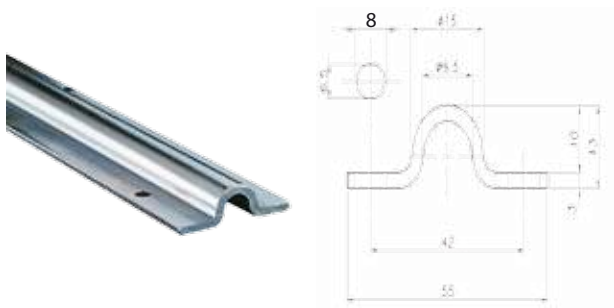

SEG13

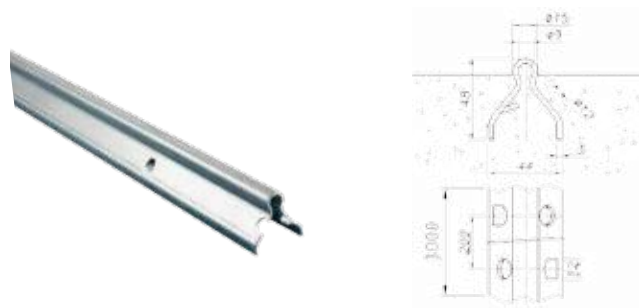

SEG14



SEG15

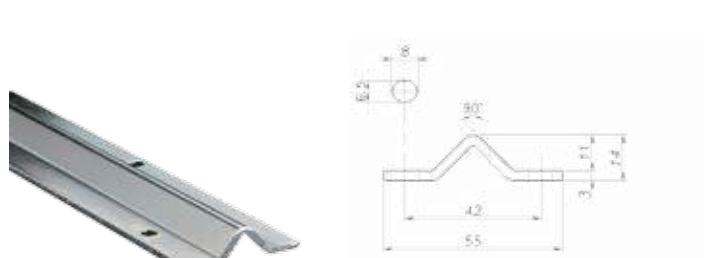

SE293

FRANÇAIS : Boîtier en acier à souder et serrure à crochet. Y compris la plaque têteère – sans barillet.

DEUTSCH : Schiebetor-Schloßkasten mit Schloß und Schließblech – ohne Zylinder.

ENGLISH : Steel lockbox to be welded, with lock and counter plate. Without the cylinder.

NEDERLANDS : Schuifpoortslotkast, incl. slot en sluitplaat, excl. cilinder.

ESPAÑOL : Caja en acero para soldar y cerrojo con gancho. Incluida la placa frontal. Se sirve sin bombillo.

RUSSE : Привариваемый корпус из стали, и замок с крючком (включая накладку без цилиндрического механизма)

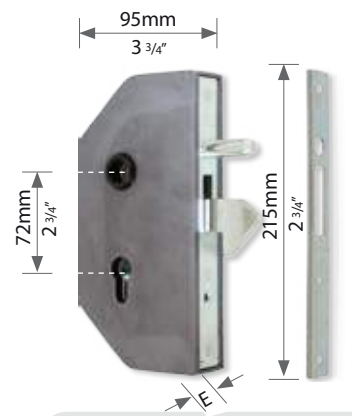

SER 43

FRANÇAIS : Butée de fin de course. A souder.

DEUTSCH : Endanschlag zum Anschweißen.

ENGLISH : End stop. To be welded.

ESPAÑOL : Tope de fin de carrera. Para soldar.

RUSSE : Конец стоп быть сваренным



SEG5

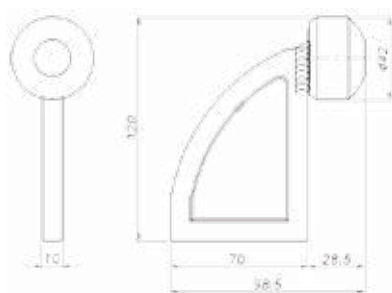

SE202

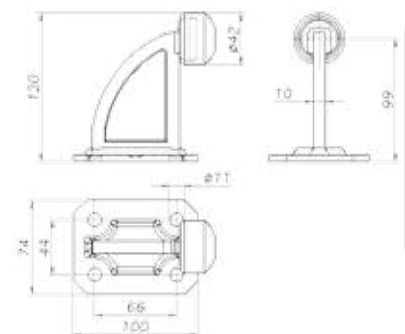

SERRURERIE - TORZUBEHÖR - HARDWARE POORTTOEBEHOREN - CERRAJERIA - ФУРНИТУРА

FRANÇAIS : Galet avec support, zingué, avec roulement à billes.
DEUTSCH : Schiebetorrolle aus Stahl, verzinkt und kugelgelagert.
ENGLISH : Steel wheel with bracket. Zinc plated. With a ball bearing.
ESPAÑOL : Rueda para puerta corredera con soporte, zincada, con rodamiento de bolas.
RUSSE : Стальное колесо с кронштейном. Оцинкованная. С шарикоподшипником

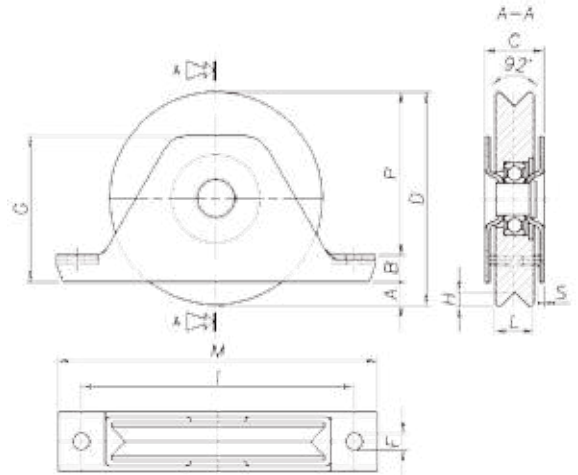

| | A | B | C | ØD | F | G | H | I | L | M | P | S | KG |
|--------------|------------------|------------------|------------------|-------------------|----------------|-----------------|----------------|-------------------|---------------|------------------|-------------------|--------------|------------------|
| SEG16 | 14 mm 9/16" | 14 mm 9/16" | 32 mm 1 5/16" | Ø78 mm 3" | Ø9 mm 5/16" | 52 mm 2 1/8" | 7 mm 1/4" | 110 mm 4 5/16" | 20 mm 3/4" | 135 mm 5 1/8" | 50 mm 2" | 3 mm 1/8" | 180 Kg 395 lb |
| SEG17 | 8,5 mm 4/16" | 14,5 mm 9/16" | 32 mm 1 5/16" | Ø88 mm 3 7/16" | Ø9 mm 5/16" | 70 mm 2 3/4" | 7,5 mm 1/4" | 130 mm 5 1/8" | 21 mm 3/4" | 155 mm 6 1/8" | 65 mm 2 9/16" | 3 mm 1/8" | 190 Kg 415 lb |
| SEG8 | 13,5 mm 9/16" | 14,5 mm 9/16" | 32 mm 1 5/16" | Ø98 mm 4" | Ø9 mm 5/16" | 70 mm 2 3/4" | 7,5 mm 1/4" | 130 mm 5 1/8" | 21 mm 3/4" | 155 mm 6 1/8" | 70 mm 2 5/8" | 3 mm 1/8" | 200 Kg 440 lb |
| SEG18 | 16,5 mm 5/8" | 15 mm 9/16" | 37 mm 1 1/2" | Ø117 mm 4 1/2" | Ø9 mm 5/16" | 80 mm 3 1/8" | 9 mm 5/16" | 155 mm 6 1/8" | 25 mm 1" | 185 mm 7 1/4" | 85,5 mm 3 3/8" | 3 mm 1/8" | 220 Kg 485 lb |

FRANÇAIS : Galet avec support, zingué, avec roulement à billes. Peut être encastré dans un tube rectangulaire de 80 x 40 mm.
DEUTSCH : Schiebetorrolle aus Stahl, verzinkt und kugelgelagert. Kann in ein 80 x 40 mm Rechteckrohr eingebaut werden.
ENGLISH : Steel wheel with bracket. Zinc plated. With a ball bearing. Use rectangular tubing, 80 x 40 mm (3 1/8 x 1 9/16).
ESPAÑOL : Rueda para puerta corredera con soporte, zincada, con rodamiento de bolas. Puede ser empotrado en tubo rectangular de 80 x 40 mm.
RUSSE : Стальное колесо с кронштейном. Оцинкованная. С шарикоподшипником. Используйте прямоугольную трубку, 80 x 40 мм

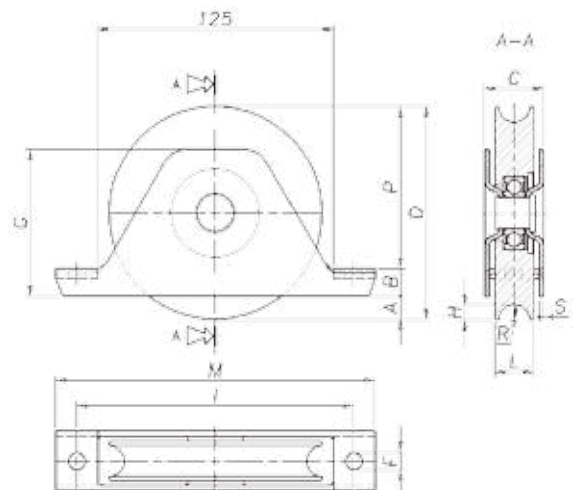

| | A | B | C | ØD | F | G | H | I | L | M | P | R | S | KG |
|-------------|------------------|------------------|------------------|-------------------|----------------|-----------------|----------------|-------------------|---------------|------------------|------------------|-----------------|--------------|------------------|
| SEG6 | 14 mm 9/16" | 14 mm 9/16" | 32 mm 1 5/16" | Ø78 mm 3" | Ø9 mm 5/16" | 52 mm 2 1/8" | 7 mm 1/4" | 110 mm 4 5/16" | 20 mm 3/4" | 135 mm 5 1/8" | 50 mm 2" | 8,5 mm 5/16" | 3 mm 1/8" | 200 Kg 440 lb |
| SEG7 | 8,5 mm 4/16" | 14,5 mm 9/16" | 32 mm 1 5/16" | Ø88 mm 3 7/16" | Ø9 mm 5/16" | 70 mm 2 3/4" | 7,5 mm 1/4" | 130 mm 5 1/8" | 21 mm 3/4" | 155 mm 6 1/8" | 65 mm 2 9/16" | 8,5 mm 5/16" | 3 mm 1/8" | 220 Kg 485 lb |
| SEG9 | 13,5 mm 9/16" | 14,5 mm 9/16" | 32 mm 1 5/16" | Ø98 mm 4" | Ø9 mm 5/16" | 70 mm 2 3/4" | 7,5 mm 1/4" | 130 mm 5 1/8" | 21 mm 3/4" | 155 mm 6 1/8" | 70 mm 2 5/8" | 8,5 mm 5/16" | 3 mm 1/8" | 380 Kg 835 lb |

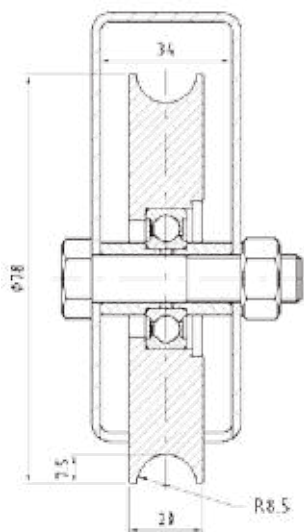

SE310  300 Kg
660 lb

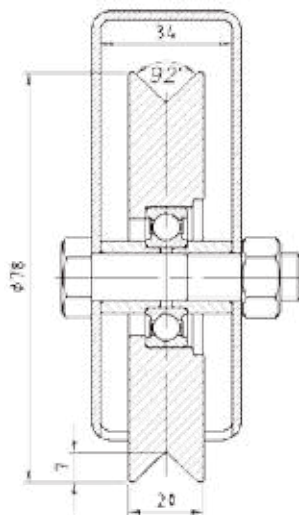

SE300  200 Kg
440 lb

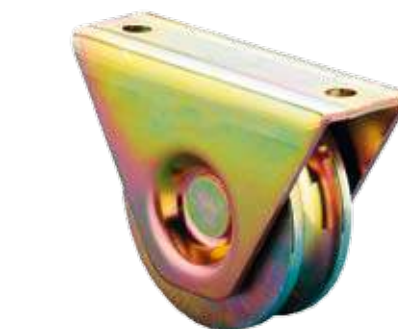
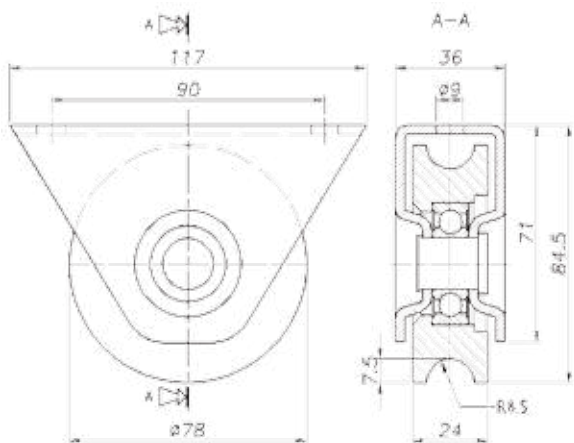

SE327  200 Kg
440 lb

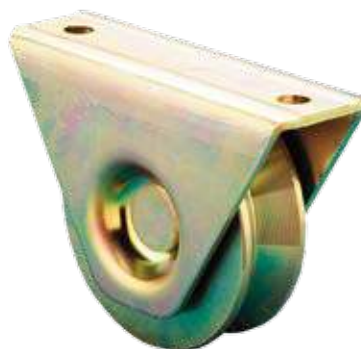
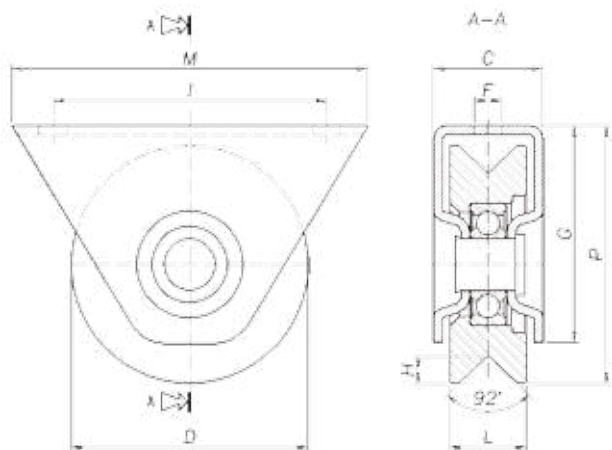

| | C | ØD | ØF | G | H | I | L | M | P |  |
|-----------------|-----------------|----------------------|-------------------|-------------------|----------------|------------------|-----------------|------------------|--------------------|---|
| SE325-60 | 25 mm 1" | Ø 60 mm Ø 2 3/8" | Ø 7 mm Ø 1/4" | 55,5 mm 2 1/4" | 6,5 mm 1/4" | 63 mm 2 1/2" | 16,5 mm 5/8" | 80 mm 3 1/8" | 65,5 mm 2 9/16" | 100 Kg 220 lb |
| SE325-80 | 36 mm 1 3/8" | Ø 78 mm Ø 3 1/16" | Ø 9 mm Ø 5/16" | 71 mm 2 13/16" | 10 mm 7/16" | 90 mm 3 9/16" | 24 mm 7/8" | 117 mm 4 1/2" | 84,5 mm 3 1/8" | 200 Kg 440 lb |

SERRURERIE

SERRURERIE - TORZUBEHÖR - HARDWARE POORTTOEBEHOREN - CERRAJERIA - ФУРНИТУРА

FRANÇAIS : Crémaillère en nylon avec corps en acier. Faible sonorité.
DEUTSCH : Nylon-Zahnstange mit Stahlkörper.
ENGLISH : Nylon rack with steel body. Reduced sound.
ESPAÑOL : Cremallera de nailón con cuerpo de acero. Baja sonoridad.
RUSSE : Нейлоновая стойка со стальным корпусом. Уменьшенный звук

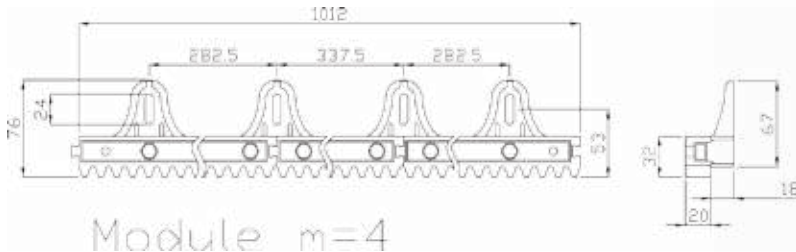

SEG31

FRANÇAIS : Crémaillère Module M4, livrée avec entretoises à souder et vis de fixation.
DEUTSCH : Zahnstange Modul M4, geliefert mit Zwischenstücken zum Anschweißen und Befestigungsschrauben.
ENGLISH : Rack Module M4, delivered with distance pieces to be welded and fixing screws.
ESPAÑOL : Cremallera Módulo M4. Se suministra con testigos para soldar y tornillo de fijación.
RUSSE : rack Модуль M4, поставляется с отрезными отрезками и крепежными винтами

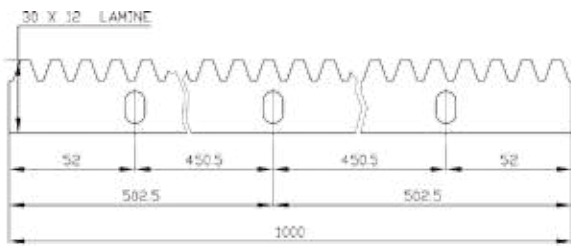

MODULE m=4
ANGLE OF PRESSION α = 20°

SEG30

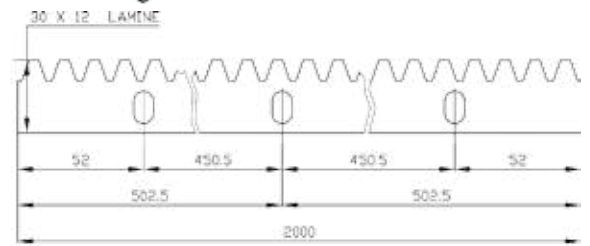

MODULE m=4
ANGLE OF PRESSION α = 20°

SEG32

FRANÇAIS : Butée supérieure réglable avec rouleaux en nylon.
DEUTSCH : Regulierbarer oberer Einlaufschuh mit Nylonrolle.
ENGLISH : Adjustable upper end stop with nylon roller.

ESPAÑOL : Tope superior regulable con rodillos de nailon.
RUSSE : Регулируемый верхний ограничитель с нейлоновым роликом



| | R |
|---------------|---------------------------------|
| SEU30M | 53-76 mm 2 1/8" - 3" |
| SEU30P | 86-114 mm 3 1/8" - 4 1/2" |
| SEU30G | 103-150 mm 3 15/16" - 5 7/8" |

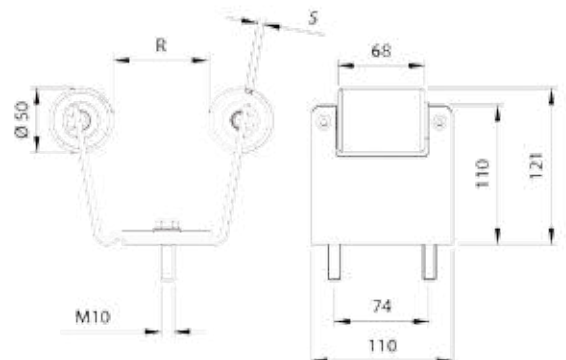

FRANÇAIS : Platinés galvanisées avec galets de guidage en nylon.

DEUTSCH : Führungsbügel, verstellbar mit Nylon Rollen.

ENGLISH : Galvanized plates with nylon rollers.

ESPAÑOL : Pletinas galvanizadas con casquillo guía de nylon.

RUSSE : Оцинкованные пластины с нейлоновыми роликами

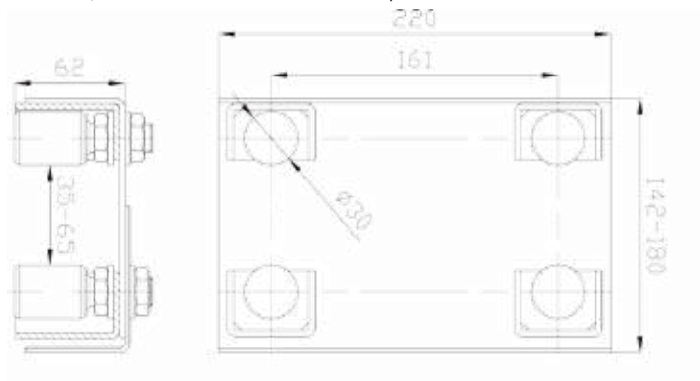

SEG1

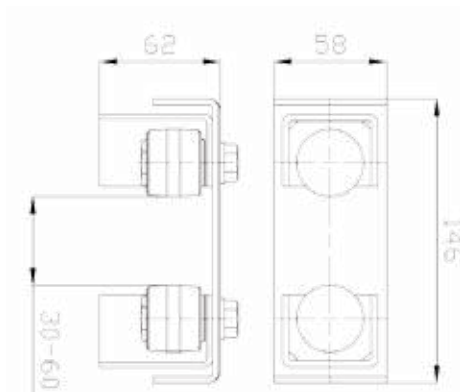

SEG2

FRANÇAIS : Galet de guidage en nylon.

DEUTSCH : Nylon Führungsrolle.

ENGLISH : Nylon guiding roller.

ESPAÑOL : Casquillo de guía de Nylon

RUSSE : Нейлоновый направляющий ролик

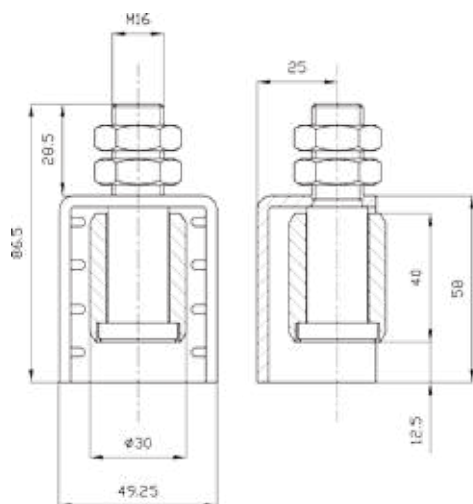

SEG3

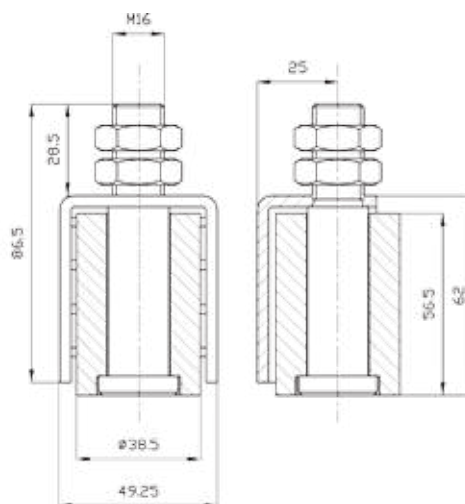

SEG4



SERRURERIE

GUIDAGE EN PORTE-A-FAUX - FREITRAGENDES SCHIEBETORSYSTEM
CANTILEVER GATE SYSTEM - GUÍA DESLIZANTE - КОНСОЛЬНЫЕ ВОРОТА

SE250M,P,G



SE250M

FRANÇAIS: Tirants en acier inox pour réglage des portails autoportants. Pour tube 60 x 60 x 3 mm.

DEUTSCH: Spannschloß aus Inoxstahl zur Torregulierung. Für 60 x 60 x 3 mm Rohre.

ENGLISH: Adjustable Stainless steel anchors for cantilever gates. For 60 x 60 x 3 mm tube.

ESPAÑOL: Tirantes en acero inoxidable para el réglage portales autoportantes. Para tubo de 60 x 30 x 3mm.

RUSSE: Регулируемые анкера из нержавеющей стали для консольных ворот. Для трубки 60 x 60 x 3 мм



SET40

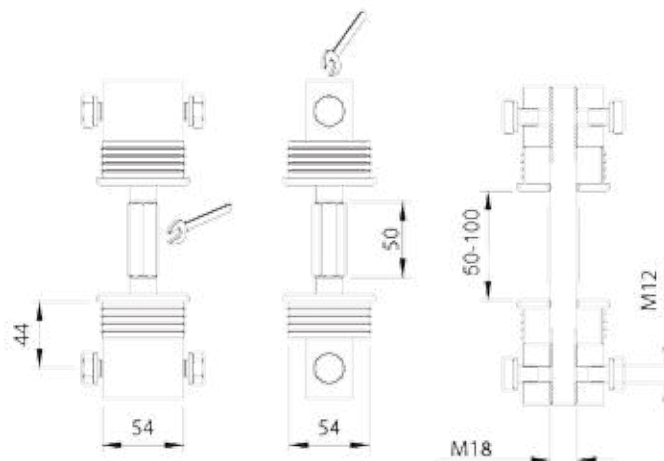

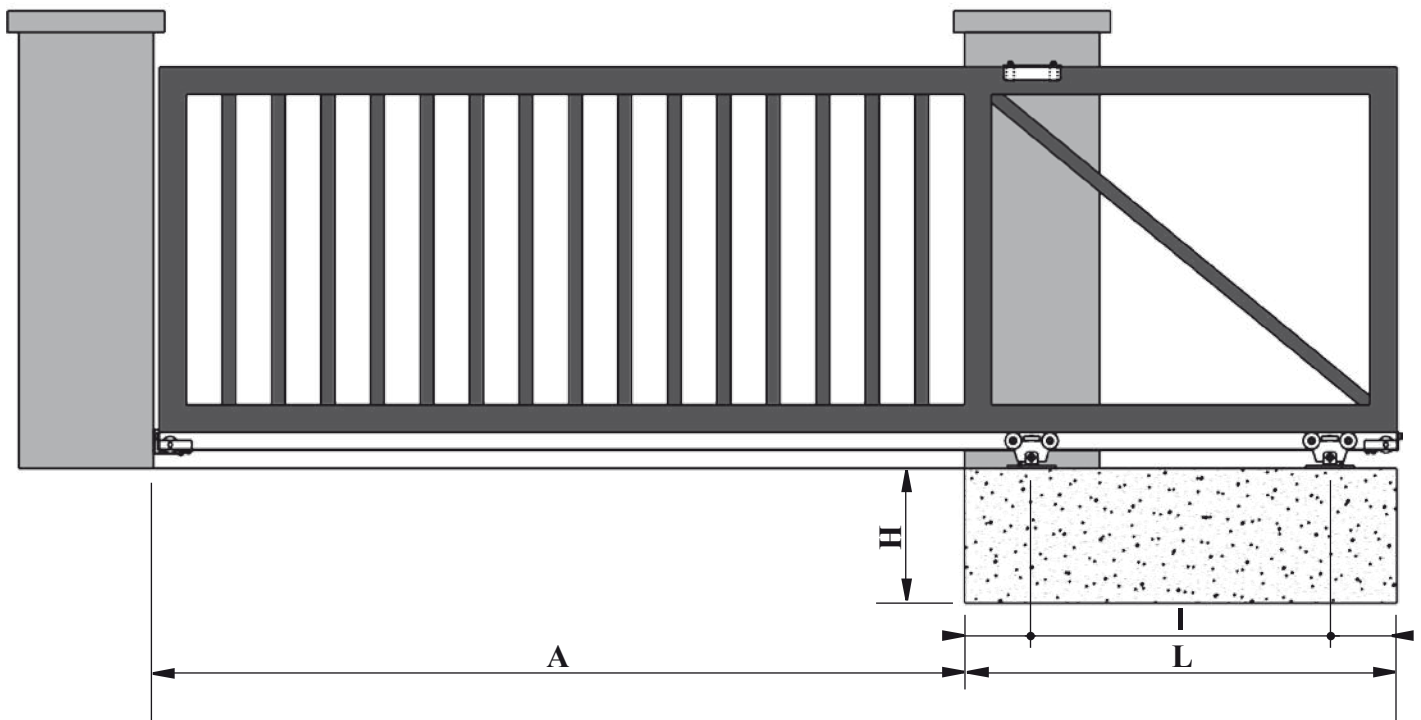

- A** Ouverture (distance entre poteaux) / Öffnung (Distanz zwischen den Pfosten)
 Opening (distance between posts) / Apertura (distancia entre balaustres de arranque)
 Открытие (расстояние между постами)
- P** Poids total du portail / Gesamtgewicht des Tors
 Total weight of the gate / Peso total del portal / Общий вес ворот
- M** Poids nu du portail (sans rail de guidage ni accessoires)
 Torgewicht (ohne Laufschiene und ohne Zubehör)
 Weight of the gate (without gate track or accessories)
 Peso del portal (sin carril-guía ni accesorios)
 Вес ворот (без направляющих ворот или аксессуаров)
- T** Poids du rail et des accessoires / Gewicht der Laufschiene und des Zubehörs
 Weight of the gate track and accessories / Peso del carril y de los accesorios
 Вес рельса и аксессуаров
- I** Entraxe des unités de guidage / Führungsblöcke Abstand / Distance between guide rollers
 Distancia entre ejes de las guías / Расстояние между направляющими роликами
- L** Longueur de fondation / Fundamentlänge / Foundation length / Longitud del cimiento
 Длина основания
- H** Profondeur de fondation / Fundamenttiefe / Foundation depth / Profundidad del cimiento
 Глубина основания

Les valeurs indiquées dans le tableau sont des minima. En particulier, la hauteur H de la fondation devra tenir compte de particularités géographiques telles que gel, vent, etc...

Die in der Tabelle angegebenen Werte sind Mindestwerte. Insbesondere die Höhe H des Fundaments muß geographische Besonderheiten wie Frost, Wind usw. in Anspruch nehmen.

For height 'H' it is important to consider changes brought about by weather conditions such as frost, wind etc.

Los valores indicados en la tabla son los mínimos. En particular la altura H del cimiento deberá tener en cuenta las particularidades geográficas tales como: hielo, viento, etc.

Для высоты 'H' важно учитывать изменения, вызванные погодными условиями, такими как мороз, ветер и т. Д

SERRURERIE - TORZUBEHÖR - HARDWARE POORTTOEBEHOREN - CERRAJERIA - ФУРНИТУРА

M = 500 KG MAXI

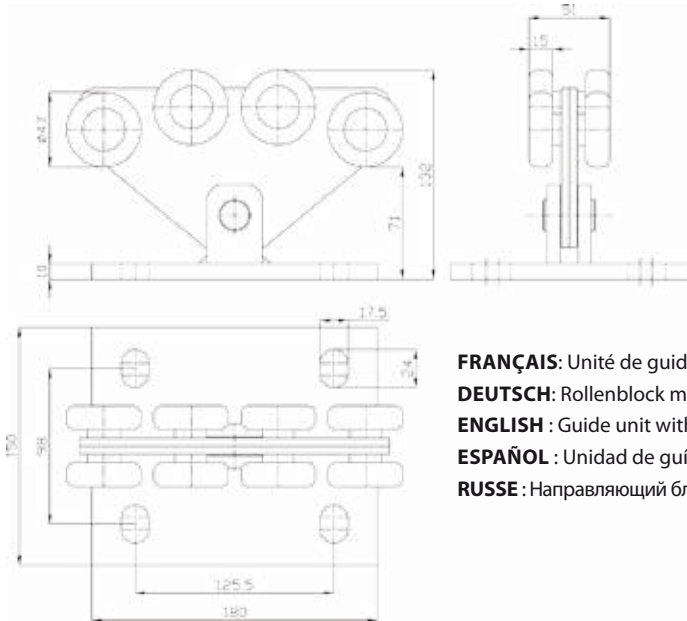

FRANÇAIS: Unité de guidage équipée de roulements à bille.
DEUTSCH: Rollenblock mit Kugellager ausgerüstet.
ENGLISH: Guide unit with ball-bearing
ESPAÑOL: Unidad de guía equipada con rodamiento de bolas.
RUSSE: Направляющий блок с шарикоподшипником



SE250M

KG
1000 Kg
2200 lb

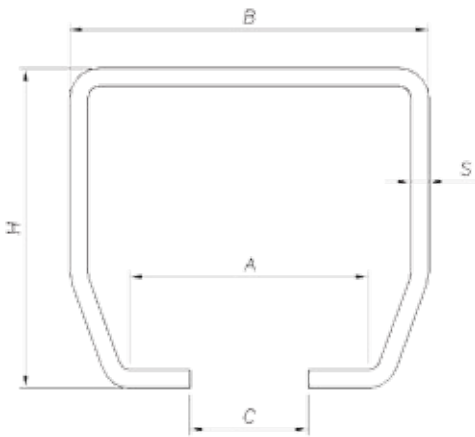

FRANÇAIS: Rail en acier zingué.
DEUTSCH: Stahlaufschiebe verzinkt.
ENGLISH: Zinc plated steel rail.
ESPAÑOL: Rail en acero zincado.
RUSSE: Оцинкованный стальной рельс



| | A | B | C | H | S | L |
|-----------------|------------------|-------------------|-----------------|-------------------|----------------|-------------------|
| SE345M | 52 mm 2 1/16" | 68 mm 2 11/16" | 23 mm 15/16" | 68 mm 2 11/16" | 3,5 mm 1/8" | 3000 mm 10 ft. |
| SE345M-6 | 52 mm 2 1/16" | 68 mm 2 11/16" | 23 mm 15/16" | 71 mm 2 13/16" | 3,5 mm 1/8" | 6000 mm 20 ft. |

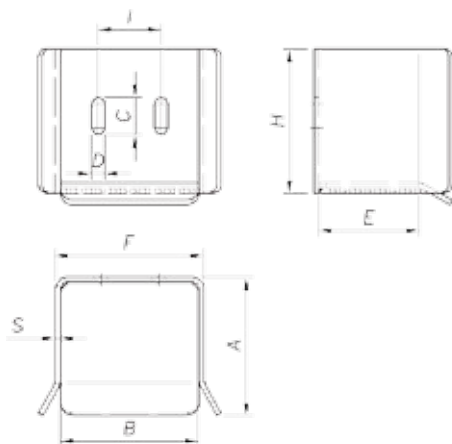

FRANÇAIS: Butée de décharge.
DEUTSCH: Einlaufschuh.
ENGLISH: End stop.
ESPAÑOL: Tope de cierre.
RUSSE: Конец стоп



| | A | B | C | D | E | F | H | I | S |
|---------------|--------------|-----------------|-------------|---------------|-------------------|------------------|-----------------|------------------|---------------|
| SE346M | 104 mm 4" | 78 mm 3 1/8" | 25 mm 1" | 9 mm 5/16" | 75 mm 2 15/16" | 82 mm 3 1/16" | 91 mm 3 1/2" | 38 mm 1 9/16" | 4 mm 3/16" |

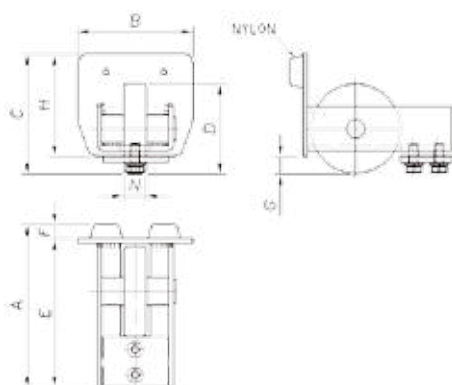

FRANÇAIS: Plaque d'extrémité avec galet de décharge.
DEUTSCH: Endplatte mit Auflaufrolle.
ENGLISH: End plate complete with roller.
ESPAÑOL: Placa de extremo con rueda de tope.
RUSSE: Концевая плита в комплекте с роликом



| | A | B | C | ØD | E | F | G | H | N |
|---------------|------------------|-------------------|-------------------|---------------------|--------------------|---------------|------------------|-----------------|----------------|
| SE347M | 135 mm 5 1/4" | 68 mm 2 11/16" | 82.5 mm 3 1/8" | Ø 68 mm Ø 2 3/4" | 123 mm 4 15/16" | 12 mm 1/2" | 14,5 mm 9/16" | 68 mm 2 3/4" | 15 mm 9/16" |

M = 500 KG MAXI

| | |
|---|---------------|
| Poids nu du portail (sans rail de guidage ni accessoires) Torgewicht (ohne Laufschiene und ohne Zubehör) Weight of the gate (without gate track or accessories) / Peso del portal (sin carril-guía ni accesorios) / Вес ворот (без направляющих ворот или аксессуаров) | 500 Kg |
| Largeur de fondation / Fundamentbreite / Foundation width / Ancho del cimiento / Ширина основания | 0,5 m |
| Distance de l'axe du patin au bord de fondation (patin = unité de guidage) Distanz zwischen Rollenblockachse und Fundamentbord / Distance between guide unit axle and foundation edge / Distancia del eje del patín al borde de la cimentación / Расстояние между осью направляющего устройства и краем фундамента | 0,3 m |
| Poids au mètre du rail / Gewicht auf Laufschiene meter Weight rails per meter / Peso del metro de carril / Вес на метр рельса | 6,1 Kg |
| Poids des accessoires / Zubehörgewicht Weight of accessories / Peso de los accesorios / Вес аксессуаров | 4 Kg |

| A (m) | 3,00 | | | | | 4,00 | | | | | 5,00 | | | | |
|-------|--------|-------|-------|-------|-------|--------|-------|-------|-------|-------|--------|-------|-------|-------|-------|
| M(kg) | P (kg) | I (m) | L (m) | T(kg) | H (m) | P (kg) | I (m) | L (m) | T(kg) | H (m) | P (kg) | I (m) | L (m) | T(kg) | H (m) |
| 100 | 125 | 0,26 | 0,86 | 27,57 | 3,37 | 134 | 0,36 | 0,96 | 34,24 | 3,02 | 141 | 0,46 | 1,06 | 40,96 | 2,70 |
| 150 | 175 | 0,39 | 0,99 | 28,34 | 2,76 | 165 | 0,52 | 1,12 | 35,25 | 2,42 | 192 | 0,67 | 1,27 | 42,22 | 2,13 |
| 200 | 229 | 0,54 | 1,14 | 29,23 | 2,26 | 236 | 0,71 | 1,31 | 36,40 | 1,94 | 244 | 0,90 | 1,50 | 43,66 | 1,68 |
| 250 | 260 | 0,70 | 1,30 | 30,23 | 1,84 | 288 | 0,93 | 1,53 | 37,73 | 1,55 | 295 | 1,17 | 1,77 | 45,32 | 1,32 |
| 300 | 331 | 0,89 | 1,49 | 31,40 | 1,49 | 339 | 1,18 | 1,78 | 39,26 | 1,24 | 347 | 1,49 | 2,09 | 47,25 | 1,04 |
| 350 | 383 | 1,12 | 1,72 | 32,77 | 1,20 | 391 | 1,48 | 2,08 | 41,07 | 0,98 | 400 | 1,86 | 2,46 | 49,52 | 0,81 |
| 400 | 434 | 1,38 | 1,98 | 34,39 | 0,95 | 443 | 1,83 | 2,43 | 43,23 | 0,76 | 452 | 2,31 | 2,91 | 52,26 | 0,63 |
| 500 | 539 | 2,10 | 2,70 | 38,79 | 0,57 | 549 | 2,80 | 3,40 | 49,15 | 0,44 | 560 | 3,56 | 4,16 | 59,69 | 0,35 |

| A (m) | 6,00 | | | | | 7,00 | | | | | 8,00 | | | | |
|-------|--------|-------|-------|-------|-------|--------|-------|-------|-------|-------|--------|-------|-------|-------|-------|
| M(kg) | P (kg) | I (m) | L (m) | T(kg) | H (m) | P (kg) | I (m) | L (m) | T(kg) | H (m) | P (kg) | I (m) | L (m) | T(kg) | H (m) |
| 100 | 148 | 0,57 | 1,17 | 47,75 | 2,42 | 155 | 0,69 | 1,29 | 54,60 | 2,18 | 162 | 0,83 | 1,43 | 61,51 | 1,96 |
| 150 | 199 | 0,82 | 1,42 | 49,27 | 1,88 | 206 | 0,99 | 1,59 | 56,39 | 1,67 | 214 | 1,17 | 1,77 | 63,58 | 1,48 |
| 200 | 251 | 1,11 | 1,71 | 51,01 | 1,46 | 258 | 1,32 | 1,92 | 58,44 | 1,28 | 266 | 1,56 | 2,16 | 65,96 | 1,13 |
| 250 | 303 | 1,43 | 2,03 | 53,01 | 1,14 | 311 | 1,71 | 2,31 | 60,81 | 0,99 | 319 | 2,01 | 2,61 | 68,73 | 0,87 |
| 300 | 355 | 1,82 | 2,42 | 55,36 | 0,89 | 364 | 2,17 | 2,77 | 63,60 | 0,77 | 372 | 2,55 | 3,15 | 72,00 | 0,67 |
| 350 | 408 | 2,28 | 2,88 | 58,14 | 0,69 | 417 | 2,72 | 3,32 | 66,94 | 0,59 | 426 | 3,19 | 3,79 | 75,92 | 0,50 |
| 400 | 462 | 2,83 | 3,43 | 61,51 | 0,52 | 471 | 3,38 | 3,98 | 71,00 | 0,44 | 481 | 3,98 | 4,58 | 80,74 | 0,38 |
| 500 | 571 | 4,39 | 4,99 | 71,06 | 0,29 | 583 | 5,31 | 5,91 | 82,73 | 0,24 | 595 | 6,32 | 6,92 | 94,99 | 0,20 |

| A (m) | 9,00 | | | | | 10,00 | | | | |
|-------|--------|-------|-------|--------|-------|--------|-------|-------|--------|-------|
| M(kg) | P (kg) | I (m) | L (m) | T(kg) | H (m) | P (kg) | I (m) | L (m) | T(kg) | H (m) |
| 100 | 168 | 0,97 | 1,57 | 68,49 | 1,76 | 176 | 1,13 | 1,73 | 75,54 | 1,59 |
| 150 | 221 | 1,36 | 1,96 | 70,86 | 1,32 | 228 | 1,57 | 2,17 | 78,22 | 1,19 |
| 200 | 274 | 1,81 | 2,41 | 73,59 | 1,01 | 281 | 2,07 | 2,67 | 81,31 | 0,90 |
| 250 | 327 | 2,33 | 2,93 | 76,77 | 0,77 | 335 | 2,67 | 3,27 | 84,94 | 0,68 |
| 300 | 381 | 2,95 | 3,55 | 80,55 | 0,58 | 389 | 3,38 | 3,98 | 89,27 | 0,51 |
| 350 | 435 | 3,70 | 4,30 | 85,11 | 0,44 | 445 | 4,24 | 4,84 | 94,53 | 0,38 |
| 400 | 491 | 4,63 | 5,23 | 90,78 | 0,32 | 501 | 5,32 | 5,92 | 101,14 | 0,28 |
| 500 | 608 | 7,44 | 8,04 | 107,97 | 0,16 | 622 | 8,71 | 9,31 | 121,82 | 0,14 |

SERRURERIE - TORZUBEHÖR - HARDWARE POORTTOEBEHOREN - CERRAJERIA - ФУРНИТУРА

P = 700 KG MAXI

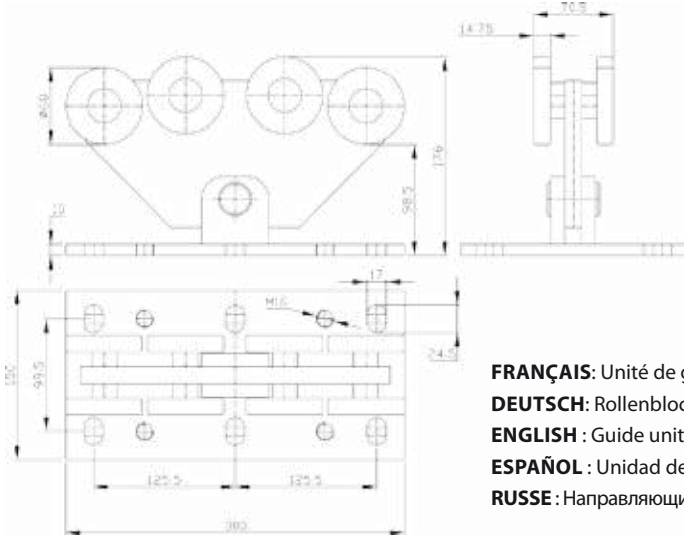

FRANÇAIS: Unité de guidage équipée de roulements à bille.
DEUTSCH: Rollenblock mit Kugellager ausgerüstet.
ENGLISH: Guide unit with ball-bearing
ESPAÑOL: Unidad de guía equipada con rodamiento de bolas.
RUSSE: Направляющий блок с шарикоподшипником



SE250P

1600 Kg
3500 lb

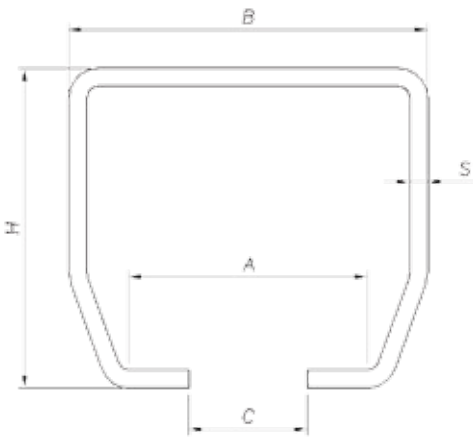

FRANÇAIS: Rail en acier zingué.
DEUTSCH: Stahllaufschiebe verzinkt.
ENGLISH: Zinc plated steel rail.
ESPAÑOL: Rail en acero zincado.
RUSSE: Оцинкованный стальной рельс

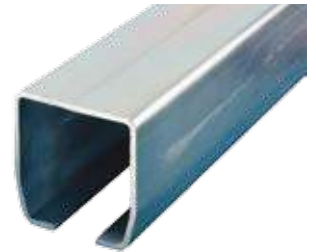

| | A | B | C | H | S | L |
|-----------------|------------------------|--------------|------------------|------------------|--------------|-------------------|
| SE345P | 73,8 mm 2 15/16" 4" | 100 mm 4" | 33 mm 1 5/16" | 89 mm 3 7/16" | 5 mm 1/4" | 3000 mm 10 ft. |
| SE345P-6 | 73,8 mm 2 15/16" 4" | 100 mm 4" | 33 mm 1 5/16" | 89 mm 3 7/16" | 5 mm 1/4" | 6000 mm 20 ft. |

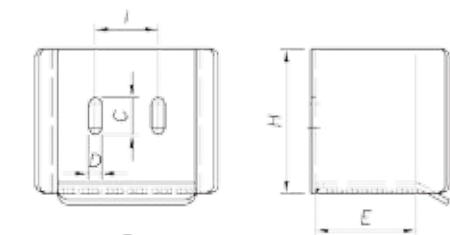

FRANÇAIS: Butée de décharge.
DEUTSCH: Einlaufschuh.
ENGLISH: End stop.
ESPAÑOL: Tope de cierre.
RUSSE: Конец стоп



| | A | B | C | D | E | F | H | I | S |
|---------------|------------------|------------------|------------------|----------------|-----------------|------------------|------------------|-------------|---------------|
| SE346P | 115 mm 4 1/2" | 112 mm 4 1/2" | 30 mm 1 3/16" | 11 mm 7/16" | 84 mm 3 3/8" | 116 mm 4 1/2" | 112 mm 4 1/2" | 50 mm 2" | 4 mm 3/16" |

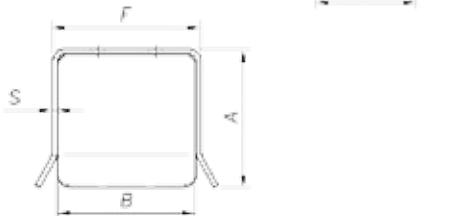

FRANÇAIS: Plaque d'extrémité avec galet de décharge.
DEUTSCH: Endplatte mit Auflaufrolle.
ENGLISH: End plate complete with roller.
ESPAÑOL: Placa de extremo con rueda de tope.
RUSSE: Концевая плита в комплекте с роликом



| | A | B | C | ØD | E | F | G | H | N |
|---------------|------------------|--------------------|------------------|-----------------|------------------|---------------|----------------|------------------|---------------|
| SE347P | 141 mm 5 1/4" | 100 mm 2 11/16" | 104 mm 3 1/8" | Ø 78 mm Ø 3" | 129 mm 5 1/8" | 12 mm 1/2" | 15 mm 9/16" | 89 mm 3 7/16" | 20 mm 3/4" |

P = 700 KG MAXI

| | |
|---|----------------|
| Poids nu du portail (sans rail de guidage ni accessoires) Torgewicht (ohne Laufschiene und ohne Zubehör) Weight of the gate (without gate track or accessories) / Peso del portal (sin carril-guía ni accesorios) / Вес ворот (без направляющих ворот или аксессуаров) | 700 Kg |
| Largeur de fondation / Fundamentbreite / Foundation width / Ancho del cimiento / Ширина основания | 0,6 m |
| Distance de l'axe du patin au bord de fondation (patin = unité de guidage) Distanz zwischen Rollenblockachse und Fundamentbord / Distance between guide unit axle and foundation edge / Distancia del eje del patín al borde de la cimentación / Расстояние между осью направляющего устройства и краем фундамента | 0,3 m |
| Poids au mètre du rail / Gewicht auf Laufschiene meter / Weight rails per meter / Peso del metro de carril / Вес на метр рельса | 11,7 Kg |
| Poids des accessoires / Zubehörgewicht Weight of accessories / Peso de los accesorios / Вес аксессуаров | 7 Kg |

| A (m) | 5,00 | | | | | 6,00 | | | | | 7,00 | | | | |
|-------|--------|-------|-------|--------|-------|--------|-------|-------|--------|-------|--------|-------|-------|--------|-------|
| M(kg) | P (kg) | I (m) | L (m) | T(kg) | H (m) | P (kg) | I (m) | L (m) | T(kg) | H (m) | P (kg) | I (m) | L (m) | T(kg) | H (m) |
| 200 | 278 | 0,59 | 1,19 | 79,26 | 1,85 | 293 | 0,74 | 1,24 | 92,64 | 1,63 | 306 | 0,90 | 1,50 | 106,19 | 1,44 |
| 250 | 331 | 0,73 | 1,33 | 80,87 | 1,59 | 345 | 0,91 | 1,51 | 94,59 | 1,39 | 358 | 1,10 | 1,70 | 108,50 | 1,22 |
| 300 | 383 | 0,88 | 1,48 | 82,62 | 1,37 | 397 | 1,09 | 1,69 | 96,72 | 1,19 | 411 | 1,31 | 1,91 | 111,02 | 1,04 |
| 350 | 435 | 1,04 | 1,64 | 84,54 | 1,18 | 449 | 1,29 | 1,89 | 99,05 | 1,02 | 464 | 1,55 | 2,15 | 113,79 | 0,88 |
| 400 | 487 | 1,22 | 1,82 | 86,63 | 1,02 | 502 | 1,51 | 2,11 | 101,61 | 0,87 | 517 | 1,81 | 2,41 | 116,85 | 0,75 |
| 500 | 592 | 1,64 | 2,24 | 91,52 | 0,75 | 608 | 2,02 | 2,62 | 107,60 | 0,63 | 624 | 2,43 | 3,03 | 124,05 | 0,54 |
| 600 | 698 | 2,16 | 2,76 | 97,61 | 0,54 | 715 | 2,67 | 3,27 | 115,15 | 0,45 | 733 | 3,21 | 3,81 | 133,20 | 0,38 |
| 700 | 805 | 2,84 | 3,44 | 105,48 | 0,39 | 825 | 3,51 | 4,11 | 125,02 | 0,31 | 845 | 4,26 | 4,86 | 145,37 | 0,26 |

| A (m) | 8,00 | | | | | 9,00 | | | | | 10,00 | | | | |
|-------|--------|-------|-------|--------|-------|--------|-------|-------|--------|-------|--------|-------|-------|--------|-------|
| M(kg) | P (kg) | I (m) | L (m) | T(kg) | H (m) | P (kg) | I (m) | L (m) | T(kg) | H (m) | P (kg) | I (m) | L (m) | T(kg) | H (m) |
| 200 | 320 | 1,07 | 1,67 | 119,90 | 1,27 | 334 | 1,27 | 1,87 | 133,80 | 1,13 | 348 | 1,47 | 2,07 | 147,89 | 1,01 |
| 250 | 373 | 1,31 | 1,91 | 122,60 | 1,07 | 387 | 1,53 | 2,13 | 136,90 | 0,95 | 401 | 1,78 | 2,38 | 151,42 | 0,84 |
| 300 | 426 | 1,56 | 2,16 | 125,54 | 0,91 | 440 | 1,82 | 2,42 | 140,30 | 0,80 | 455 | 2,11 | 2,71 | 155,30 | 0,70 |
| 350 | 479 | 1,84 | 2,44 | 128,79 | 0,77 | 494 | 2,14 | 2,74 | 144,06 | 0,67 | 510 | 2,48 | 3,08 | 159,61 | 0,59 |
| 400 | 532 | 2,14 | 2,74 | 132,39 | 0,65 | 548 | 2,50 | 3,10 | 148,23 | 0,57 | 564 | 2,89 | 3,49 | 164,41 | 0,49 |
| 500 | 641 | 2,87 | 3,47 | 140,89 | 0,46 | 658 | 3,35 | 3,95 | 158,18 | 0,40 | 676 | 3,88 | 4,48 | 175,95 | 0,34 |
| 600 | 752 | 3,81 | 4,41 | 151,84 | 0,32 | 771 | 4,47 | 5,07 | 171,15 | 0,27 | 791 | 5,18 | 5,78 | 191,21 | 0,23 |
| 700 | 867 | 5,08 | 5,68 | 166,67 | 0,22 | 889 | 6,00 | 6,60 | 189,09 | 0,18 | 913 | 7,04 | 7,64 | 212,87 | 0,15 |

| A (m) | 11,00 | | | | | 12,00 | | | | |
|-------|--------|-------|-------|--------|-------|--------|-------|-------|--------|-------|
| M(kg) | P (kg) | I (m) | L (m) | T(kg) | H (m) | P (kg) | I (m) | L (m) | T(kg) | H (m) |
| 200 | 362 | 1,70 | 2,30 | 162,18 | 0,90 | 377 | 1,94 | 2,54 | 176,68 | 0,80 |
| 250 | 416 | 2,04 | 2,64 | 166,17 | 0,75 | 431 | 2,32 | 2,92 | 181,16 | 0,67 |
| 300 | 471 | 2,42 | 3,02 | 170,57 | 0,62 | 486 | 2,75 | 3,35 | 186,13 | 0,55 |
| 350 | 525 | 2,84 | 3,44 | 175,47 | 0,52 | 542 | 3,22 | 3,82 | 191,67 | 0,46 |
| 400 | 581 | 3,31 | 3,91 | 180,96 | 0,43 | 598 | 3,76 | 4,36 | 197,91 | 0,38 |
| 500 | 694 | 4,45 | 5,05 | 194,25 | 0,30 | 713 | 5,07 | 5,67 | 213,17 | 0,26 |
| 600 | 812 | 5,98 | 6,58 | 212,14 | 0,20 | 834 | 6,84 | 7,46 | 234,11 | 0,17 |
| 700 | 938 | 8,23 | 8,83 | 238,37 | 0,12 | 966 | 9,60 | 10,20 | 266,09 | 0,10 |

SERRURERIE - TORZUBEHÖR - HARDWARE POORTTOEBEHOREN - CERRAJERIA - ФУРНИТУРА

G = 1000 KG MAXI

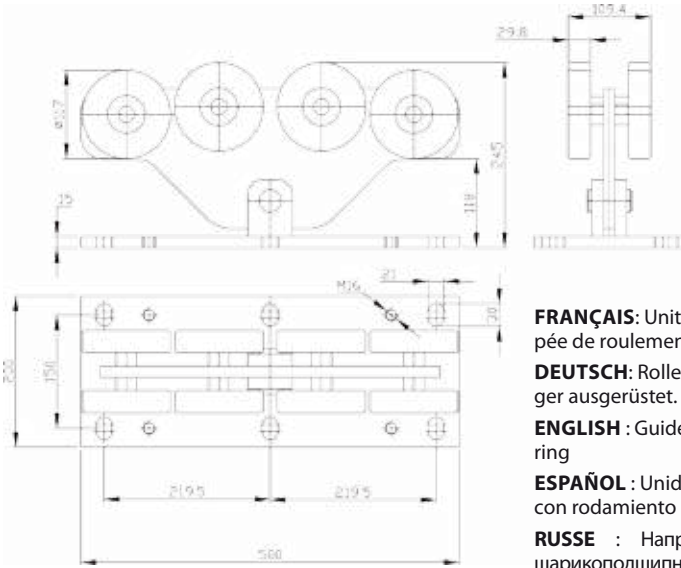

FRANÇAIS: Unité de guidage équipée de roulements à bille.

DEUTSCH: Rollenblock mit Kugellager ausgerüstet.

ENGLISH: Guide unit with ball-bearing

ESPAÑOL: Unidad de guía equipada con rodamiento de bolas.

RUSSE: Направляющий блок с шарикоподшипником



SE250G

3000 Kg
6600 lb

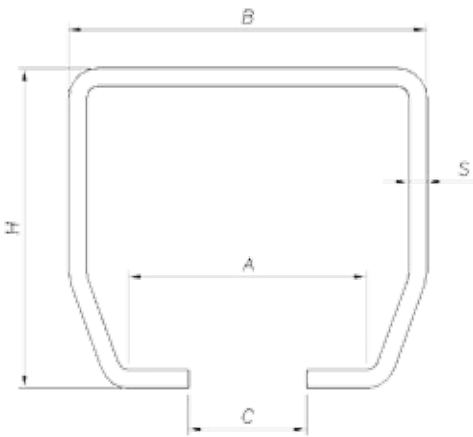

FRANÇAIS: Rail en acier zingué.

DEUTSCH: Stahllaufschiebe verzinkt.

ENGLISH: Zinc plated steel rail.

ESPAÑOL: Rail en acero zincado.

RUSSE: Оцинкованный стальной рельс



| | A | B | C | H | S | L |
|-----------------|-------------------|------------------|-----------------|------------------|--------------|-------------------|
| SE345G | 108 mm 4 5/16" | 142 mm 5 1/2" | 38 mm 1 1/2" | 142 mm 5 1/2" | 6 mm 1/4" | 3000 mm 10 ft. |
| SE345G-6 | 108 mm 4 5/16" | 142 mm 5 1/2" | 38 mm 1 1/2" | 142 mm 5 1/2" | 6 mm 1/4" | 6000 mm 20 ft. |

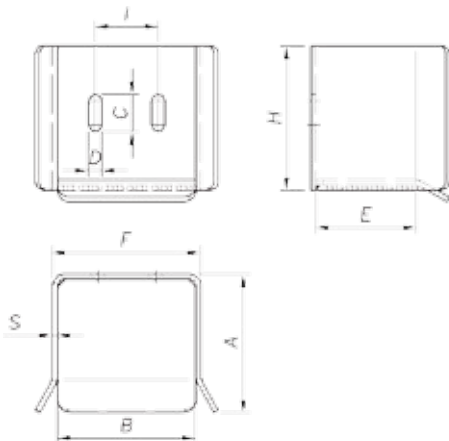

FRANÇAIS: Butée de décharge.

DEUTSCH: Einlaufschuh.

ENGLISH: End stop.

ESPAÑOL: Tope de cierre.

RUSSE: Конец стоп



| | A | B | C | D | E | F | H | I | S |
|---------------|-------------------|------------------|-----------------|---------------|------------------|-------------------|------------------|-------------------|--------------|
| SE346G | 159 mm 6 5/16" | 154 mm 6 1/8" | 35 mm 1 3/8" | 13 mm 1/2" | 120 mm 4 3/4" | 159 mm 6 5/16" | 165 mm 6 1/2" | 77 mm 2 15/16" | 5 mm 1/4" |

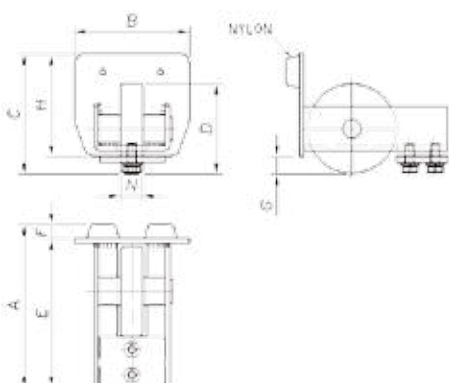

FRANÇAIS: Plaque d'extrémité avec galet de décharge.

DEUTSCH: Endplatte mit Auflaufrolle.

ENGLISH: End plate complete with roller.

ESPAÑOL: Placa de extremo con rueda de tope.

RUSSE: Концевая плита в комплекте с роликом



| | A | B | C | ØD | E | F | G | H | N |
|---------------|--------------------|--------------------|------------------|---------------|--------------------|---------------|----------------|--------------------|------------------|
| SE347G | 195 mm 7 11/16" | 140 mm 2 11/16" | 155 mm 6 1/8" | Ø98 mm Ø4" | 170 mm 6 11/16" | 24,5 mm 1" | 15 mm 9/16" | 140 mm 2 11/16" | 30 mm 1 3/16" |

G = 1000 KG MAXI

| | |
|---|----------------|
| Poids nu du portail (sans rail de guidage ni accessoires) Torgewicht (ohne Laufschiene und ohne Zubehör) Weight of the gate (without gate track or accessories) Peso del portal (sin carril-guía ni accesorios) / Вес ворот (без направляющих ворот или аксессуаров) | 1000 Kg |
| Largeur de fondation / Fundamentbreite / Foundation width / Ancho del cimiento / Ширина основания | 0,6 m |
| Distance de l'axe du patin au bord de fondation (patin = unité de guidage) Distanz zwischen Rollenblockachse und Fundamentbord / Distance between guide unit axle and foundation edge / Distancia del eje del patín al borde de la cimentación / Расстояние между осью направляющего устройства и краем фундамента | 0,4 m |
| Poids au mètre du rail / Gewicht auf Laufschiene meter / Weight rails per meter / Peso del metro de carril / Вес на метр рельса | 22,4 Kg |
| Poids des accessoires / Zubehörgewicht Weight of accessories / Peso de los accesorios / Вес аксессуаров | 7 Kg |

| A (m) | 6,00 | | | | | 8,00 | | | | | 10,00 | | | | |
|-------|--------|-------|-------|--------|-------|--------|-------|-------|--------|-------|--------|-------|-------|--------|-------|
| M(kg) | P (kg) | I (m) | L (m) | T(kg) | H (m) | P (kg) | I (m) | L (m) | T(kg) | H (m) | P (kg) | I (m) | L (m) | T(kg) | H (m) |
| 300 | 483 | 0,65 | 1,45 | 183,09 | 2,89 | 535 | 0,95 | 1,75 | 234,50 | 2,34 | 587 | 1,31 | 2,11 | 287,23 | 1,90 |
| 400 | 587 | 0,83 | 1,63 | 184,99 | 2,47 | 640 | 1,19 | 1,99 | 239,84 | 1,97 | 694 | 1,63 | 2,43 | 294,19 | 1,58 |
| 500 | 691 | 1,02 | 1,82 | 191,25 | 2,12 | 746 | 1,46 | 2,26 | 245,71 | 1,67 | 802 | 1,97 | 2,77 | 301,88 | 1,32 |
| 600 | 796 | 1,23 | 2,03 | 195,94 | 1,81 | 852 | 1,75 | 2,55 | 252,19 | 1,41 | 910 | 2,35 | 3,15 | 310,43 | 1,10 |
| 700 | 901 | 1,46 | 2,26 | 201,12 | 1,55 | 959 | 2,07 | 2,87 | 259,41 | 1,19 | 1020 | 2,78 | 3,58 | 320,02 | 0,92 |
| 800 | 1007 | 1,72 | 2,52 | 206,88 | 1,32 | 1067 | 2,43 | 3,23 | 267,49 | 1,00 | 1131 | 3,27 | 4,07 | 330,86 | 0,77 |
| 900 | 1113 | 2,01 | 2,81 | 213,33 | 1,12 | 1177 | 2,84 | 3,64 | 276,62 | 0,84 | 1243 | 3,82 | 4,62 | 343,25 | 0,63 |
| 1000 | 1221 | 2,33 | 3,13 | 220,62 | 0,95 | 1287 | 3,31 | 4,11 | 287,05 | 0,70 | 1358 | 4,46 | 5,26 | 357,59 | 0,52 |

| A (m) | 12,00 | | | | | 14,00 | | | | | 16,00 | | | | |
|-------|--------|-------|-------|--------|-------|--------|-------|-------|--------|-------|--------|-------|-------|--------|-------|
| M(kg) | P (kg) | I (m) | L (m) | T(kg) | H (m) | P (kg) | I (m) | L (m) | T(kg) | H (m) | P (kg) | I (m) | L (m) | T(kg) | H (m) |
| 300 | 641 | 1,74 | 2,54 | 341,44 | 1,55 | 697 | 2,24 | 3,04 | 397,29 | 1,26 | 755 | 2,83 | 3,63 | 455,02 | 1,03 |
| 400 | 750 | 2,13 | 2,93 | 350,23 | 1,28 | 808 | 2,73 | 3,53 | 408,19 | 1,04 | 868 | 3,42 | 4,22 | 468,36 | 0,84 |
| 500 | 860 | 2,57 | 3,37 | 360,01 | 1,06 | 920 | 3,28 | 4,08 | 420,40 | 0,85 | 983 | 4,10 | 4,90 | 483,43 | 0,69 |
| 600 | 971 | 3,06 | 3,86 | 370,97 | 0,88 | 1034 | 3,89 | 4,69 | 434,20 | 0,70 | 1101 | 4,87 | 5,67 | 500,66 | 0,56 |
| 700 | 1083 | 3,62 | 4,42 | 383,37 | 0,72 | 1150 | 4,60 | 5,40 | 450,00 | 0,57 | 1221 | 5,76 | 6,56 | 520,64 | 0,45 |
| 800 | 1198 | 4,25 | 5,05 | 397,54 | 0,59 | 1268 | 5,42 | 6,22 | 468,31 | 0,46 | 1344 | 6,82 | 7,62 | 544,27 | 0,36 |
| 900 | 1314 | 4,99 | 5,79 | 413,98 | 0,49 | 1399 | 6,39 | 7,19 | 489,95 | 0,37 | 1473 | 8,19 | 8,99 | 572,91 | 0,29 |
| 1000 | 1433 | 5,86 | 6,66 | 433,37 | 0,39 | 1516 | 7,56 | 8,36 | 516,15 | 0,30 | 1609 | 9,72 | 10,52 | 608,97 | 0,22 |

| A (m) | 18,00 | | | | | 20,00 | | | | |
|-------|--------|-------|-------|--------|-------|--------|-------|-------|--------|-------|
| M(kg) | P (kg) | I (m) | L (m) | T(kg) | H (m) | P (kg) | I (m) | L (m) | T(kg) | H (m) |
| 300 | 815 | 3,51 | 4,31 | 514,91 | 0,85 | 877 | 4,30 | 5,10 | 577,29 | 0,69 |
| 400 | 931 | 4,23 | 5,03 | 531,10 | 0,69 | 997 | 5,18 | 5,98 | 596,90 | 0,56 |
| 500 | 1050 | 5,06 | 5,86 | 549,60 | 0,55 | 1120 | 6,19 | 6,99 | 619,61 | 0,45 |
| 600 | 1171 | 6,02 | 6,82 | 571,05 | 0,45 | 1246 | 7,39 | 8,19 | 646,41 | 0,36 |
| 700 | 1296 | 7,15 | 7,95 | 596,39 | 0,36 | 1379 | 8,85 | 9,65 | 678,89 | 0,28 |
| 800 | 1427 | 8,53 | 9,33 | 627,13 | 0,28 | 1520 | 10,68 | 11,48 | 719,63 | 0,21 |
| 900 | 1566 | 10,26 | 11,06 | 665,66 | 0,22 | 1675 | 13,15 | 13,95 | 774,97 | 0,16 |
| 1000 | 1718 | 12,60 | 13,40 | 718,01 | 0,16 | 1831 | 16,99 | 17,79 | 860,75 | 0,11 |

| | |
|---------|-----|
| AD30 | 188 |
| AD40 | 188 |
| AK180 | 180 |
| AK181 | 180 |
| AK240 | 180 |
| AK241 | 180 |
| ALUB112 | 118 |
| ALUB115 | 118 |
| ALUB133 | 118 |
| ALUB512 | 118 |
| ALUB515 | 118 |
| ALUB915 | 118 |
| ALUB933 | 118 |
| ALUD10 | 119 |
| ALUD11 | 119 |
| ALUD13 | 119 |
| ALUD18L | 119 |
| ALUD18R | 119 |
| ALUD24L | 119 |
| ALUD24R | 119 |
| ALUD27 | 119 |
| ALUD400 | 119 |
| ALUD45 | 119 |
| ALUD60 | 119 |
| ALUD7 | 119 |
| ALUD95 | 119 |
| ALUP110 | 118 |
| ALUP111 | 118 |
| ALUP333 | 118 |
| ALUP550 | 118 |
| ALUP555 | 118 |
| ALUT12 | 119 |
| ALUT15 | 119 |
| ALUT19 | 119 |
| ALUT6 | 119 |
| ALUT7 | 119 |
| ALUT8 | 119 |
| AR6 | 212 |
| B0101 | 157 |
| B0102 | 157 |
| B0104 | 157 |
| B0106 | 157 |
| B0109VB | 131 |
| B0201 | 157 |
| B0202 | 157 |
| B0204 | 157 |
| B0206 | 157 |

| | |
|---------|-----|
| B0209VB | 131 |
| B0401 | 159 |
| B0402 | 159 |
| B0404 | 159 |
| B0701 | 157 |
| B0702 | 157 |
| B0704 | 157 |
| B0706 | 157 |
| B0801 | 157 |
| B0802 | 157 |
| B0804 | 157 |
| B0806 | 157 |
| B0901 | 157 |
| B0902 | 157 |
| B0904 | 157 |
| B100 | 158 |
| B101 | 158 |
| B1011 | 158 |
| B1012 | 158 |
| B1014 | 158 |
| B1016 | 158 |
| B1404 | 161 |
| B1551 | 158 |
| B1552 | 158 |
| B1554 | 158 |
| B1601 | 160 |
| B1602 | 160 |
| B1604 | 160 |
| B1701 | 156 |
| B1702 | 156 |
| B1704 | 156 |
| B1709VB | 130 |
| B1801 | 159 |
| B1802 | 159 |
| B1804 | 159 |
| B1809VB | 131 |
| B1911 | 158 |
| B1912 | 158 |
| B1914 | 158 |
| B1916 | 158 |
| B2002 | 173 |
| B2003 | 173 |
| B2102 | 173 |
| B2103 | 173 |
| B2202 | 173 |
| B2203 | 173 |
| B2302 | 173 |

| | |
|---------|-----|
| B2303 | 173 |
| B2711 | 160 |
| B2712 | 160 |
| B2714 | 160 |
| B3001 | 156 |
| B3002 | 156 |
| B3004 | 156 |
| B3006 | 156 |
| B3009VB | 130 |
| B3104 | 156 |
| B3201 | 156 |
| B3202 | 156 |
| B3204 | 156 |
| B3206 | 156 |
| B3209VB | 130 |
| B3601 | 159 |
| B3602 | 159 |
| B3604 | 159 |
| B3609VB | 130 |
| B3711 | 160 |
| B3712 | 160 |
| B3714 | 160 |
| B4001 | 161 |
| B4002 | 161 |
| B4004 | 161 |
| B4006 | 161 |
| B4009VB | 130 |
| B4104 | 161 |
| B4604 | 160 |
| B4701 | 160 |
| B4702 | 160 |
| B4704 | 160 |
| B4801 | 160 |
| B4802 | 160 |
| B4804 | 160 |
| B5001 | 159 |
| B5002 | 159 |
| B5004 | 159 |
| B5104 | 161 |
| B5302 | 137 |
| B5303 | 137 |
| B5402 | 137 |
| B5403 | 137 |
| B5404 | 137 |
| B5502 | 137 |
| B5503 | 137 |
| B5504 | 137 |

| | |
|---------|-----|
| B6105 | 49 |
| B6105W | 50 |
| B6105WP | 50 |
| B6106 | 49 |
| B6111 | 171 |
| B6112 | 171 |
| B6114 | 171 |
| B6211 | 171 |
| B6212 | 171 |
| B6214 | 171 |
| B6311 | 171 |
| B6312 | 171 |
| B6314 | 171 |
| B6411 | 171 |
| B6412 | 171 |
| B6414 | 171 |
| B6505 | 49 |
| B6506 | 49 |
| B6705 | 49 |
| B6706 | 49 |
| B7101 | 169 |
| B7102 | 169 |
| B7104 | 169 |
| B7106 | 169 |
| B7109FN | 129 |
| B714 | 140 |
| B7201 | 169 |
| B7202 | 169 |
| B7204 | 169 |
| B7206 | 169 |
| B7209FN | 129 |
| B724 | 140 |
| B726 | 141 |
| B7401 | 169 |
| B7402 | 169 |
| B7404 | 169 |
| B7406 | 169 |
| B7409FN | 129 |
| B7501 | 169 |
| B7502 | 169 |
| B7504 | 169 |
| B7509FN | 129 |
| B7601 | 169 |
| B7602 | 169 |
| B7604 | 169 |
| B7606 | 169 |
| B7609FN | 129 |

| | |
|--------------|----|
| B8101 | 67 |
| B8102 | 82 |
| B8104 | 82 |
| B8106 | 82 |
| B8201 | 82 |
| B8202 | 82 |
| B8204 | 67 |
| B8206 | 67 |
| B9111 | 94 |
| B9112 | 94 |
| B9114 | 94 |
| B9116 | 94 |
| B9201 | 94 |
| B9202 | 94 |
| B9204 | 94 |
| B9206 | 94 |
| BCAR10-K-BLU | 94 |
| BCAR10-K-CN | 94 |
| BCAR10-K-G | 94 |
| BCAR10-K-NI | 94 |
| BCAR10-K-RED | 94 |
| BCAR10-K-SA | 94 |
| BCAR10-K-SPE | 94 |
| BCAR10-K-WHI | 94 |
| BCAR10-R-BLU | 63 |
| BCAR10-R-CN | 94 |
| BCAR10-R-G | 63 |
| BCAR10-R-NI | 94 |
| BCAR10-R-RED | 36 |
| BCAR10-R-SA | 36 |
| BCAR10-R-SPE | 36 |
| BCAR10-R-WHI | 36 |
| BCAR10-W-BLU | 36 |
| BCAR10-W-CN | 36 |
| BCAR10-W-G | 36 |
| BCAR10-W-NI | 36 |
| BCAR10-W-RED | 36 |
| BCAR10-W-SA | 36 |
| BCAR10-W-SPE | 36 |
| BCAR10-W-WHI | 36 |
| BCAR11-K-BLU | 36 |
| BCAR11-K-CN | 36 |
| BCAR11-K-G | 36 |
| BCAR11-K-NI | 36 |
| BCAR11-K-RED | 36 |
| BCAR11-K-SA | 29 |
| BCAR11-K-SPE | 36 |

| | |
|--------------|-----|
| BCAR11-K-WHI | 95 |
| BCAR11-R-BLU | 94 |
| BCAR11-R-CN | 96 |
| BCAR11-R-G | 99 |
| BCAR11-R-NI | 99 |
| BCAR11-R-RED | 93 |
| BCAR11-R-SA | 99 |
| BCAR11-R-SPE | 100 |
| BCAR11-R-WHI | 95 |
| BCAR11-W-BLU | 94 |
| BCAR11-W-CN | 96 |
| BCAR11-W-G | 99 |
| BCAR11-W-NI | 99 |
| BCAR11-W-RED | 93 |
| BCAR11-W-SA | 99 |
| BCAR11-W-SPE | 100 |
| BCAR11-W-WHI | 95 |
| BCL12 | 182 |
| BCL23 | 182 |
| BCL33 | 182 |
| BCL38 | 182 |
| BCLA38 | 182 |
| BCLB38 | 182 |
| BDB724K | 123 |
| BDB724K-GO | 125 |
| BDB724K-LA | 126 |
| BDB724K-TE | 124 |
| BDB724R | 123 |
| BDB724R-GO | 125 |
| BDB724R-LA | 126 |
| BDB724R-TE | 124 |
| BDB734K | 123 |
| BDB734R | 123 |
| BDCS224 | 123 |
| BDCS4 | 123 |
| BDCS6 | 123 |
| BDCS616 | 123 |
| BDCS7 | 123 |
| BDCS825 | 123 |
| BDCS835 | 123 |
| BDP700K | 123 |
| BDP700K-GO | 125 |
| BDP700K-LA | 126 |
| BDP700K-TE | 124 |
| BDP700R | 123 |
| BDP700R-GO | 125 |
| BDP700R-LA | 126 |

| | |
|------------|-----|
| BDP700R-TE | 124 |
| BDP710K | 123 |
| BDP710R | 123 |
| BDT30 | 123 |
| BDT30-GO | 125 |
| BDT30-LA | 126 |
| BDT30-TE | 124 |
| BDT35 | 123 |
| BF20 | 212 |
| BL102 | 53 |
| BL102NI | 54 |
| BL102NI-F | 55 |
| BL103 | 53 |
| BL103NI | 54 |
| BL103NI-F | 55 |
| BL105 | 53 |
| BL105NI | 54 |
| BL105NI-F | 55 |
| BL107 | 53 |
| BL107NI | 54 |
| BL107NI-F | 55 |
| BL113 | 45 |
| BL113CN | 47 |
| BL113NI | 46 |
| BL115 | 45 |
| BL115CN | 47 |
| BL115NI | 46 |
| BL116 | 45 |
| BL116CN | 47 |
| BL116NI | 46 |
| BL118 | 45 |
| BL118CN | 47 |
| BL118NI | 46 |
| BL120L | 27 |
| BL120L-F | 29 |
| BL120NI | 27 |
| BL120NI-F | 29 |
| BL122L | 26 |
| BL122L-F | 28 |
| BL122NI | 26 |
| BL122NI-F | 28 |
| BL126L | 27 |
| BL126L-F | 29 |
| BL126NI | 27 |
| BL126NI-F | 29 |
| BL127L | 26 |
| BL127L-F | 28 |

| | |
|--------------|----|
| BL127NI | 26 |
| BL127NI-F | 28 |
| BL129L | 27 |
| BL129L-F | 29 |
| BL129NI | 27 |
| BL129NI-F | 29 |
| BL144 | 40 |
| BL144NIP | 42 |
| BL145 | 41 |
| BL145NIP | 43 |
| BL147 | 40 |
| BL147NIP | 42 |
| BL148 | 41 |
| BL148NIP | 43 |
| BL149 | 41 |
| BL149NIP | 43 |
| BL159 | 41 |
| BL159NIP | 43 |
| BL175K | 20 |
| BL175KRG | 22 |
| BL175KSA | 23 |
| BL175R | 20 |
| BL175RRG | 22 |
| BL175RSA | 23 |
| BL177K | 20 |
| BL177K-JR-RG | 22 |
| BL177K-LA-SA | 23 |
| BL177R | 20 |
| BL177R-JR-RG | 22 |
| BL177R-LA-SA | 23 |
| BL178K | 20 |
| BL178KRG | 22 |
| BL178KSA | 23 |
| BL178R | 20 |
| BL178RRG | 22 |
| BL178RSA | 23 |
| BL179K | 20 |
| BL179KRG | 22 |
| BL179KSA | 23 |
| BL179R | 20 |
| BL179RRG | 22 |
| BL179RSA | 23 |
| BL243K | 14 |
| BL243K-GO-CN | 16 |
| BL243R | 14 |
| BL243R-GO-CN | 16 |
| BL244K | 14 |

| | |
|--------------|-----|
| BL244R | 14 |
| BL245K | 14 |
| BL245KCN | 16 |
| BL245R | 14 |
| BL245RCN | 16 |
| BL246K | 14 |
| BL246K-GO-CN | 16 |
| BL246R | 14 |
| BL246R-GO-CN | 16 |
| BL420 | 33 |
| BL420RG | 35 |
| BL421 | 32 |
| BL421RG | 34 |
| BL422 | 32 |
| BL422RG | 34 |
| BL423 | 33 |
| BL423RG | 35 |
| BL424 | 33 |
| BL424RG | 35 |
| BL427 | 33 |
| BL427RG | 35 |
| BL441 | 37 |
| BL442 | 37 |
| BL443 | 37 |
| BL444 | 37 |
| BL445 | 37 |
| BL501 | 9 |
| BL501NI | 10 |
| BL502 | 9 |
| BL502NI | 10 |
| BL511 | 9 |
| BL511NI | 10 |
| BL512 | 9 |
| BL512NI | 10 |
| BL531 | 8 |
| BL531-TE-NI | 10 |
| BL541 | 8 |
| BL551 | 8 |
| BL551-TE-NI | 10 |
| BL561 | 8 |
| BL715 | 140 |
| BL725 | 140 |
| BL727 | 141 |
| BR502 | 136 |
| BR503 | 136 |
| BR512 | 136 |
| BR513 | 136 |

| | |
|--------|-----|
| BR522 | 136 |
| BR523 | 136 |
| BR532 | 136 |
| BR533 | 136 |
| BR542 | 136 |
| BR543 | 136 |
| BR552 | 138 |
| BR553 | 138 |
| BR562 | 138 |
| BR563 | 138 |
| BR572 | 138 |
| BR573 | 138 |
| BR612 | 139 |
| BR613 | 139 |
| BR614 | 139 |
| BR622 | 139 |
| BR623 | 139 |
| BR624 | 139 |
| BR632 | 139 |
| BR633 | 139 |
| BR652 | 139 |
| BR653 | 139 |
| BW12 | 80 |
| BW15 | 80 |
| BW912 | 80 |
| BW915 | 80 |
| C1101 | 186 |
| C1102 | 186 |
| C1104 | 186 |
| C1201 | 186 |
| C1202 | 186 |
| C1203 | 186 |
| C1204 | 186 |
| C12-1M | 180 |
| C12-2M | 180 |
| C12-3M | 180 |
| C1301 | 186 |
| C1302 | 186 |
| C1303 | 186 |
| C1304 | 186 |
| C14-1M | 180 |
| C14-2M | 180 |
| C14-3M | 180 |
| C1601 | 186 |
| C1602 | 186 |
| C1603 | 186 |
| C1604 | 186 |

| | |
|---------|-----|
| C16-1M | 180 |
| C16-2M | 180 |
| C16-3M | 180 |
| C2001 | 186 |
| C2002 | 186 |
| C2003 | 186 |
| C2004 | 186 |
| C20-1M | 180 |
| C20-2M | 180 |
| C20-3M | 180 |
| C25-1M | 180 |
| C25-2M | 180 |
| C25-3M | 180 |
| C3302 | 186 |
| C3303 | 186 |
| C3304 | 186 |
| C4802 | 183 |
| CHA10 | 194 |
| CK232 | 182 |
| CK274 | 182 |
| CL101 | 194 |
| CL102 | 194 |
| CL103 | 194 |
| CL104 | 194 |
| CL105 | 194 |
| CL106 | 194 |
| CL107 | 194 |
| CL108 | 194 |
| CL120 | 194 |
| CL14 | 194 |
| CL148 | 194 |
| CL160 | 194 |
| CL161 | 194 |
| CL162 | 194 |
| CLEANER | 89 |
| CM121 | 169 |
| CM122 | 169 |
| CM124 | 169 |
| CM131 | 169 |
| CM132 | 169 |
| CM134 | 169 |
| CM161 | 169 |
| CM162 | 169 |
| CM164 | 169 |
| CO70 | 177 |
| CO75 | 176 |
| CO-CARB | 97 |

| | |
|--------------|-----|
| COL45 | 60 |
| COL45P | 60 |
| COL50 | 60 |
| COL50P | 60 |
| COL60P | 60 |
| CORDE150-BLK | 102 |
| CORDE150-RED | 102 |
| CORDE200-BLK | 102 |
| CORDE200-RED | 102 |
| CORDE250-BLK | 102 |
| CORDE250-RED | 102 |
| CR101 | 184 |
| CR102 | 184 |
| CR111 | 184 |
| CR112 | 184 |
| CR114 | 184 |
| CR115 | 151 |
| CR116 | 151 |
| CR121 | 184 |
| CR122 | 184 |
| CR123 | 184 |
| CR131 | 184 |
| CR132 | 184 |
| CR133 | 184 |
| CR134 | 184 |
| CRC101 | 171 |
| CRC102 | 171 |
| CRC111 | 171 |
| CRC112 | 171 |
| CRC132 | 171 |
| CRV131 | 184 |
| CRV132 | 184 |
| CS120 | 196 |
| CS121 | 196 |
| CS140 | 196 |
| CS141 | 196 |
| CS160 | 196 |
| CS161 | 196 |
| CS168 | 196 |
| CS200 | 196 |
| CS201 | 196 |
| CS203 | 197 |
| CS205 | 196 |
| CS240 | 196 |
| CS241 | 196 |
| CS250 | 196 |
| CS251 | 196 |

| | |
|-----------|-----|
| CS50 | 196 |
| CS80 | 196 |
| CSK16-BLU | 94 |
| CSK16CARB | 93 |
| CSK16-RED | 93 |
| CSK16-SPE | 100 |
| CSK16-WHI | 95 |
| CSK35-BLU | 94 |
| CSK35CARB | 93 |
| CSK35-RED | 93 |
| CSK35-SPE | 100 |
| CSK35-WHI | 95 |
| CSKF16 | 196 |
| CSKF16L | 67 |
| CSKF16NI | 27 |
| CSKF35 | 196 |
| CSKF35L | 67 |
| CSL10 | 67 |
| CSL10P | 67 |
| CSL113 | 66 |
| CSL114 | 66 |
| CSL114CN | 96 |
| CSL114G | 99 |
| CSL114NI | 99 |
| CSL114SA | 99 |
| CSL140 | 66 |
| CSL147 | 66 |
| CSL16 | 67 |
| CSL16P | 67 |
| CSL18 | 67 |
| CSL18P | 67 |
| CSL30 | 67 |
| CSL30P | 67 |
| CSL40 | 67 |
| CSL403 | 66 |
| CSL40P | 67 |
| CSL50 | 66 |
| CSL51 | 66 |
| CSL51NI | 54 |
| CSL52 | 66 |
| CSL53 | 66 |
| CSL54 | 66 |
| CSL600 | 66 |
| CSL61 | 66 |
| CSL614 | 66 |
| CSL614W | 50 |
| CSL616 | 66 |

| | |
|-----------|-----|
| CSL616CN | 17 |
| CSL616G | 99 |
| CSL616NI | 10 |
| CSL616NI | 99 |
| CSL616SA | 23 |
| CSL616SA | 99 |
| CSL61CN | 96 |
| CSL61G | 99 |
| CSL61NI | 99 |
| CSL61RG | 22 |
| CSL61SA | 99 |
| CSL620 | 66 |
| CSL63 | 66 |
| CSL648 | 66 |
| CSL78 | 66 |
| CSL80 | 67 |
| CSL80P | 67 |
| CSL810 | 66 |
| CSL825 | 66 |
| CSL825W | 50 |
| CSL835 | 66 |
| CSL835CN | 96 |
| CSL835G | 99 |
| CSL835NI | 99 |
| CSL835SA | 99 |
| CSL86 | 67 |
| CSL86P | 67 |
| CSL940 | 66 |
| CSR16-BLU | 94 |
| CSR16CARB | 93 |
| CSR16-RED | 93 |
| CSR16-SPE | 100 |
| CSR16-WHI | 95 |
| CSR27 | 196 |
| CSR30 | 196 |
| CSR34 | 196 |
| CSR4 | 196 |
| CSR40-BLU | 94 |
| CSR40CARB | 93 |
| CSR40-RED | 93 |
| CSR40-SPE | 100 |
| CSR40-WHI | 95 |
| CSR42-BLU | 94 |
| CSR42CARB | 93 |
| CSR42CN | 96 |
| CSR42-G | 99 |
| CSR42-NI | 99 |

| | |
|-----------|-----|
| CSR42-RED | 93 |
| CSR42-SA | 99 |
| CSR42-SPE | 100 |
| CSR42-WHI | 95 |
| CSR6 | 196 |
| CSR7 | 196 |
| CSR8 | 196 |
| CSRF16 | 196 |
| CSRF16L | 67 |
| CSRF40 | 196 |
| CSRF40L | 67 |
| CST1 | 196 |
| CST15 | 197 |
| CST2 | 196 |
| CST3 | 197 |
| CST5 | 196 |
| CST7 | 197 |
| CST8 | 197 |
| CU160 | 177 |
| CU165 | 176 |
| CU-CARB | 97 |
| CUL45 | 60 |
| CUL45P | 60 |
| CUL50 | 60 |
| CUL50P | 60 |
| CUL60P | 60 |
| CYB110 | 150 |
| CYB111 | 150 |
| CYB120 | 150 |
| CYB121 | 150 |
| CYB130 | 150 |
| CYB131 | 150 |
| CYD112 | 151 |
| CYD113 | 151 |
| CYEL125 | 150 |
| CYEL135 | 151 |
| D101 | 185 |
| D102 | 185 |
| D104 | 185 |
| D132 | 185 |
| D134 | 185 |
| D141 | 184 |
| D142 | 184 |
| D161 | 184 |
| D162 | 184 |
| D251 | 184 |
| D252 | 184 |

| | |
|------------|-----|
| D271 | 185 |
| D272 | 185 |
| D501 | 184 |
| D502 | 184 |
| D61 | 185 |
| D62 | 185 |
| D64 | 185 |
| D71 | 184 |
| D72 | 184 |
| D74 | 184 |
| D81K | 193 |
| D82K | 193 |
| D82R | 182 |
| D83R | 182 |
| DL45L | 61 |
| DL45R | 61 |
| DL50L | 61 |
| DL50R | 61 |
| DL51 | 61 |
| DL60L | 61 |
| DL60R | 61 |
| DM61 | 168 |
| DM62 | 168 |
| DM64 | 168 |
| DR245L | 176 |
| DR245LCARB | 97 |
| DR245R | 176 |
| DR245RCARB | 97 |
| DR246 | 176 |
| DR30 | 177 |
| DR305 | 176 |
| DR305CARB | 97 |
| DR35 | 176 |
| DR90 | 177 |
| DR95 | 176 |
| DRC305 | 176 |
| DRL245 | 60 |
| DRL250 | 60 |
| DRL260 | 60 |
| DRL45 | 60 |
| DRL50 | 60 |
| DRL60 | 60 |
| DRLC45 | 60 |
| DRLC50 | 60 |
| DRLC60 | 60 |
| DS101 | 195 |
| DS120 | 195 |

| | |
|--------|-----|
| DS153 | 195 |
| DS203 | 195 |
| DS27 | 195 |
| DS33 | 195 |
| DS42 | 195 |
| DS48 | 195 |
| DS60 | 195 |
| DS76 | 195 |
| DS89 | 195 |
| EG114 | 182 |
| EG116 | 182 |
| EG118 | 182 |
| EG14 | 182 |
| EG16 | 182 |
| EG18 | 182 |
| EG20 | 182 |
| EG30 | 182 |
| EG514 | 182 |
| EG516 | 182 |
| EG518 | 182 |
| EG551 | 182 |
| EG553 | 182 |
| EG614 | 182 |
| EG616 | 182 |
| EG618 | 182 |
| EG714 | 182 |
| EG716 | 182 |
| EG718 | 182 |
| EG741 | 182 |
| EG743 | 182 |
| EG831 | 182 |
| EG833 | 182 |
| EGK100 | 193 |
| EGK12 | 193 |
| EGK125 | 193 |
| EGK14 | 193 |
| EGK16 | 193 |
| EGK20 | 193 |
| EGK25 | 193 |
| EGK31 | 193 |
| EGK32 | 193 |
| EGK33 | 193 |
| EGK42 | 193 |
| EGK46 | 193 |
| EGK51 | 193 |
| EGK52 | 193 |
| EGK58 | 193 |

| | |
|--------|-----|
| EGK66 | 193 |
| EGK80 | 193 |
| EGK82 | 193 |
| EGK85 | 193 |
| EL1872 | 182 |
| EL251 | 183 |
| EL252 | 183 |
| EL301 | 183 |
| EL302 | 183 |
| EL351 | 183 |
| EL352 | 183 |
| EL353 | 183 |
| EL354 | 183 |
| EL412 | 183 |
| EL413 | 183 |
| EL414 | 183 |
| EL482 | 183 |
| EL601 | 162 |
| EL604 | 162 |
| EL704 | 163 |
| EL705 | 163 |
| EL706 | 162 |
| EL852 | 183 |
| EL871 | 182 |
| EL872 | 182 |
| ESK202 | 183 |
| ESK342 | 183 |
| ESK912 | 183 |
| ESK922 | 183 |
| ESK972 | 183 |
| FA110 | 198 |
| FA180 | 198 |
| FAC22 | 201 |
| FAC23 | 201 |
| FAC40 | 201 |
| FAC50 | 201 |
| FAC51 | 201 |
| FAC52 | 201 |
| FAC75 | 201 |
| FAR181 | 199 |
| FAR182 | 199 |
| FAR231 | 199 |
| FAR232 | 199 |
| FDF11 | 200 |
| FDF13 | 200 |
| FDF18 | 200 |
| FDF22 | 200 |

| | |
|--------------|-----|
| FDF23 | 200 |
| FDF24 | 200 |
| FDF27 | 200 |
| FDF303 | 199 |
| FDF304 | 199 |
| FDF305 | 199 |
| FDF306 | 199 |
| FDF33 | 200 |
| FDF38 | 200 |
| FDF40 | 200 |
| FDF7 | 200 |
| FDF75 | 200 |
| FDF76 | 200 |
| FFR101 | 195 |
| FFR48 | 195 |
| FFR60 | 195 |
| FFR76 | 195 |
| FFR89 | 195 |
| FILM-CARBONE | 97 |
| FL6 | 198 |
| FL9 | 198 |
| FOB109 | 111 |
| FOB109VB | 131 |
| FOB115 | 109 |
| FOB119 | 111 |
| FOB129 | 110 |
| FOB133 | 109 |
| FOB402 | 109 |
| FOB403 | 109 |
| FOB429 | 111 |
| FOB439 | 111 |
| FOB515 | 109 |
| FOB519 | 111 |
| FOB529 | 110 |
| FOB602 | 109 |
| FOB603 | 109 |
| FOB629 | 111 |
| FOB639 | 111 |
| FOB915 | 109 |
| FOB919 | 111 |
| FOB933 | 109 |
| FOB939 | 111 |
| FOC100-ST | 195 |
| FOC123 | 197 |
| FOC123Z | 197 |
| FOC124 | 197 |
| FOC124Z | 197 |

| | |
|----------|-----|
| FOC16 | 109 |
| FOC16 | 197 |
| FOC16Z | 109 |
| FOC16Z | 197 |
| FOC19 | 111 |
| FOC224 | 197 |
| FOC224Z | 197 |
| FOC225 | 197 |
| FOC225Z | 197 |
| FOC403 | 109 |
| FOC403Z | 109 |
| FOC409 | 111 |
| FOC40-ST | 195 |
| FOC50-ST | 195 |
| FOC52 | 109 |
| FOC52 | 197 |
| FOC52Z | 109 |
| FOC52Z | 197 |
| FOC53 | 197 |
| FOC53Z | 197 |
| FOC59 | 111 |
| FOC59ID | 133 |
| FOC60-ST | 195 |
| FOC62 | 109 |
| FOC62 | 197 |
| FOC62Z | 109 |
| FOC62Z | 197 |
| FOC69 | 111 |
| FOC69ID | 133 |
| FOC71 | 197 |
| FOC71Z | 197 |
| FOC72 | 197 |
| FOC72Z | 197 |
| FOC80-ST | 195 |
| FOC82 | 197 |
| FOC82Z | 197 |
| FOC83 | 197 |
| FOC83Z | 197 |
| FOC84 | 197 |
| FOC84Z | 197 |
| FOC85 | 197 |
| FOC85Z | 197 |
| FOC89ID | 133 |
| FOD10 | 115 |
| FOD10ZD | 115 |
| FOD11 | 115 |
| FOD11ZD | 115 |

| | |
|----------|-----|
| FOD13 | 115 |
| FOD13ZD | 115 |
| FOD18L | 114 |
| FOD18LZ | 114 |
| FOD18R | 114 |
| FOD18RZ | 114 |
| FOD19 | 114 |
| FOD19Z | 114 |
| FOD22 | 114 |
| FOD22Z | 114 |
| FOD23 | 114 |
| FOD23Z | 114 |
| FOD24L | 114 |
| FOD24LZ | 114 |
| FOD24R | 114 |
| FOD24RZ | 114 |
| FOD27 | 115 |
| FOD27ZD | 115 |
| FOD33L | 114 |
| FOD33LZ | 114 |
| FOD33R | 114 |
| FOD33RZ | 114 |
| FOD40 | 113 |
| FOD400 | 113 |
| FOD400ZD | 113 |
| FOD40ZD | 113 |
| FOD45 | 113 |
| FOD45ZD | 113 |
| FOD60 | 113 |
| FOD60ZD | 113 |
| FOD7 | 115 |
| FOD75 | 114 |
| FOD75LZ | 114 |
| FOD75R | 114 |
| FOD75RZ | 114 |
| FOD76 | 114 |
| FOD76Z | 114 |
| FOD7ZD | 115 |
| FOD95 | 115 |
| FOD95ZD | 115 |
| FOM114 | 112 |
| FOM116 | 112 |
| FOM118 | 112 |
| FOM214 | 112 |
| FOM216 | 112 |
| FOM218 | 112 |
| FOM414 | 112 |

| | |
|-------------|-----|
| FOM416 | 112 |
| FOM418 | 112 |
| FOM514 | 112 |
| FOM516 | 112 |
| FOM518 | 112 |
| FOM714 | 112 |
| FOM716 | 112 |
| FOM718 | 112 |
| FOM721 | 112 |
| FOM814 | 112 |
| FOM816 | 112 |
| FOM818 | 112 |
| FOP109 | 110 |
| FOP110 | 108 |
| FOP111 | 108 |
| FOP112 | 108 |
| FOP119 | 110 |
| FOP119ID | 132 |
| FOP129 | 110 |
| FOP333 | 108 |
| FOP509 | 110 |
| FOP555 | 108 |
| FOP559 | 110 |
| FOP600 | 108 |
| FOP609 | 110 |
| FOP660 | 108 |
| FOP669 | 110 |
| FOS11-FULL | 207 |
| FOS11-NG | 207 |
| FOS11ZD | 113 |
| FOS3-FULL | 207 |
| FOS3-NG | 207 |
| FOS3ZD | 113 |
| FOS4-FULL | 207 |
| FOS4-NG | 207 |
| FOS4ZD | 113 |
| FOS5-FULL | 207 |
| FOS5-NG | 207 |
| FOS5ZD | 113 |
| FOS7-FULL | 207 |
| FOS7-NG | 207 |
| FOS7ZD | 113 |
| FOS9-FULL | 207 |
| FOS9-NG | 207 |
| FOS9ZD | 113 |
| FOSC11-FULL | 207 |
| FOSC11-NG | 207 |

| | |
|-------------|-----|
| FOSC4-FULL | 207 |
| FOSC4-NG | 207 |
| FOSC5-FULL | 207 |
| FOSC5-NG | 207 |
| FOSC7-FULL | 207 |
| FOSC7-NG | 207 |
| FOSC9-FULL | 207 |
| FOSC9-NG | 207 |
| FOT12 | 112 |
| FOT12-FULL | 206 |
| FOT12ZD | 112 |
| FOT13 | 175 |
| FOT13ZD | 175 |
| FOT15 | 112 |
| FOT15-FULL | 206 |
| FOT15-NG | 206 |
| FOT15ZD | 112 |
| FOT19 | 112 |
| FOT19-FULL | 206 |
| FOT19-NG | 206 |
| FOT19ZD | 112 |
| FOT6 | 112 |
| FOT6-FULL | 206 |
| FOT6ZD | 112 |
| FOT7 | 112 |
| FOT7-FULL | 206 |
| FOT7ZD | 112 |
| FOT8 | 112 |
| FOT8-FULL | 206 |
| FOT8ZD | 112 |
| FOTC12-FULL | 206 |
| FOTC15-FULL | 206 |
| FOTC15-NG | 206 |
| FOTC19-FULL | 206 |
| FOTC19-NG | 206 |
| FOTC7-FULL | 206 |
| FOTC8-FULL | 206 |
| FR111 | 199 |
| FR118L | 199 |
| FR118R | 199 |
| FR66L | 199 |
| FR66R | 199 |
| FR86L | 199 |
| FR86R | 199 |
| FR91 | 199 |
| FR92 | 199 |
| FRO10 | 198 |

| | |
|---------|-----|
| FRO3 | 198 |
| FRO5 | 198 |
| FV100 | 198 |
| FV50 | 198 |
| FV75 | 198 |
| G102L | 165 |
| G102M | 165 |
| G112L | 165 |
| G112M | 165 |
| G202L | 165 |
| G202M | 165 |
| G206L | 165 |
| G206M | 165 |
| G222L | 165 |
| G222M | 165 |
| G226L | 165 |
| G226M | 165 |
| G542 | 164 |
| G552 | 164 |
| G562 | 164 |
| G702L | 167 |
| G702M | 167 |
| G712L | 167 |
| G712M | 167 |
| G742L | 167 |
| G742M | 167 |
| G762L | 167 |
| G762M | 167 |
| G772 | 164 |
| G776 | 164 |
| G782 | 164 |
| G786 | 164 |
| GC1050 | 58 |
| GC1050L | 58 |
| GC8050 | 58 |
| GC8150 | 58 |
| GC8250 | 58 |
| GC8250L | 58 |
| GC8350 | 58 |
| GC8450 | 58 |
| GC8550 | 58 |
| GR110 | 198 |
| GR70 | 198 |
| GR85 | 198 |
| GV102L | 185 |
| GV102M | 185 |
| GV112L | 185 |

| | |
|----------|-----|
| GV112M | 185 |
| GV30 | 185 |
| GV55 | 185 |
| HC120 | 181 |
| HC126 | 181 |
| HC140 | 181 |
| HC146 | 181 |
| HC200 | 181 |
| HC215 | 181 |
| HC250 | 181 |
| HR120 | 181 |
| HR126 | 181 |
| HR140 | 181 |
| HR146 | 181 |
| HR160 | 181 |
| HR168 | 181 |
| HR200 | 181 |
| HR206 | 181 |
| HR215 | 181 |
| HR250 | 181 |
| HT1000 | 181 |
| HT1000-6 | 181 |
| HT200 | 181 |
| HT200-6 | 181 |
| HT250 | 181 |
| HT250-6 | 181 |
| HT300 | 181 |
| HT300-6 | 181 |
| HT320 | 181 |
| HT320-6 | 181 |
| HT400 | 181 |
| HT400-6 | 181 |
| HT420 | 181 |
| HT420-6 | 181 |
| HT430 | 181 |
| HT430-6 | 181 |
| HT500 | 181 |
| HT500-6 | 181 |
| HT530 | 181 |
| HT530-6 | 181 |
| HT600 | 181 |
| HT600-6 | 181 |
| HT640 | 181 |
| HT640-6 | 181 |
| HT800 | 181 |
| HT800-6 | 181 |
| HT840 | 181 |

| | |
|---------|-----|
| HT840-6 | 181 |
| I1201 | 183 |
| I1202 | 183 |
| I1501 | 183 |
| I1502 | 183 |
| I1503 | 183 |
| I1504 | 183 |
| J0601L | 187 |
| J0601R | 187 |
| J0602L | 187 |
| J0602R | 187 |
| J0604L | 187 |
| J0604R | 187 |
| J1001L | 187 |
| J1001R | 187 |
| J1002L | 187 |
| J1002R | 187 |
| J1004L | 187 |
| J1004R | 187 |
| J1302L | 187 |
| J1302R | 187 |
| J1303L | 187 |
| J1303R | 187 |
| J1304L | 187 |
| J1304R | 187 |
| J1501 | 203 |
| J1502 | 203 |
| J2201 | 186 |
| J2202 | 186 |
| J2203 | 186 |
| J2601 | 186 |
| J2602 | 186 |
| J2603 | 186 |
| J612 | 203 |
| J616 | 203 |
| JM151 | 203 |
| JM152 | 203 |
| JM612 | 203 |
| JM616 | 203 |
| JM61L | 169 |
| JM61R | 169 |
| JM62L | 169 |
| JM62R | 169 |
| JM64L | 169 |
| JM64R | 169 |
| K1103 | 188 |
| K1403 | 188 |

| | |
|---------|-----|
| K7502 | 188 |
| K7503 | 188 |
| K802 | 188 |
| K803 | 188 |
| KL100 | 59 |
| KL130 | 59 |
| KL15 | 59 |
| KL20 | 59 |
| KL25 | 59 |
| KL30 | 59 |
| KL40 | 59 |
| KL50 | 59 |
| KL75 | 59 |
| L1301 | 187 |
| L1302 | 187 |
| L2001 | 186 |
| L2002 | 186 |
| L2102 | 187 |
| L2103 | 187 |
| L2104 | 187 |
| L2301 | 186 |
| L2302 | 186 |
| L3002 | 187 |
| L3003 | 187 |
| L3004 | 187 |
| L3501 | 186 |
| L3502 | 186 |
| L3601 | 186 |
| L3602 | 186 |
| L3701 | 186 |
| L3702 | 186 |
| LA101 | 203 |
| LA103 | 203 |
| LA111 | 203 |
| LA111GF | 205 |
| LA141 | 202 |
| LA141GF | 204 |
| LA142 | 202 |
| LA142GF | 204 |
| LA143 | 202 |
| LA143GF | 204 |
| LA151 | 202 |
| LA151GF | 204 |
| LA152 | 202 |
| LA152GF | 204 |
| LA153 | 202 |
| LA153GF | 204 |

| | |
|---------|-----|
| LA161 | 203 |
| LA161GF | 205 |
| LA162 | 203 |
| LA162GF | 205 |
| LA163 | 203 |
| LA163GF | 205 |
| LA171 | 203 |
| LA171GF | 205 |
| LA172 | 203 |
| LA172GF | 205 |
| LA181 | 202 |
| LA181GF | 204 |
| LA182 | 202 |
| LA182GF | 204 |
| LA183 | 202 |
| LA183GF | 204 |
| LA191 | 202 |
| LA191GF | 204 |
| LA192 | 202 |
| LA192GF | 204 |
| LA193 | 202 |
| LA193GF | 204 |
| LA211 | 203 |
| LA211GF | 205 |
| LA212 | 203 |
| LA212GF | 205 |
| LA213 | 203 |
| LA213GF | 205 |
| LA22 | 203 |
| LA221 | 202 |
| LA221GF | 204 |
| LA222 | 202 |
| LA222GF | 204 |
| LA223 | 202 |
| LA223GF | 204 |
| LA22M | 203 |
| LA230 | 202 |
| LA230GF | 204 |
| LA231 | 203 |
| LA231GF | 205 |
| LA232 | 203 |
| LA232GF | 205 |
| LA233 | 203 |
| LA233GF | 205 |
| LA237 | 203 |
| LA237GF | 205 |
| LA238GF | 204 |

| | |
|------------|-----|
| LA239GF | 204 |
| LA241GF | 205 |
| LA242GF | 205 |
| LA243GF | 205 |
| LA244GF | 205 |
| LA251 | 202 |
| LA251GF | 204 |
| LA252 | 202 |
| LA252GF | 204 |
| LA253 | 202 |
| LA253GF | 204 |
| LA272 | 203 |
| LA272GF | 205 |
| LA273 | 203 |
| LA273GF | 205 |
| LA300 | 212 |
| LA31 | 203 |
| LA31GF | 205 |
| LA32 | 203 |
| LA32GF | 205 |
| LA41 | 203 |
| LA41GF | 205 |
| LA45 | 203 |
| LA45GF | 205 |
| LA51 | 203 |
| LA51GF | 205 |
| LAC14-200 | 178 |
| LAC16-1200 | 178 |
| LAC16-200 | 178 |
| LAC16-2000 | 178 |
| LAC18-1200 | 178 |
| LAC18-200 | 178 |
| LAC18-2000 | 178 |
| LAC20-1200 | 178 |
| LAC20-200 | 178 |
| LAC20-2000 | 178 |
| LAD14 | 193 |
| LAD16 | 193 |
| LAD18 | 193 |
| LAD20 | 193 |
| LAR14-1200 | 178 |
| LAR14-200 | 178 |
| LAR14-600 | 178 |
| LAR16-1200 | 178 |
| LAR16-200 | 178 |
| LAR16-2000 | 178 |
| LAR18-1200 | 178 |

| | |
|---------------|-----|
| LAR18-200 | 178 |
| LAR18-2000 | 178 |
| LAR20-1200 | 178 |
| LAR20-200 | 178 |
| LAR20-2000 | 178 |
| LM251 | 169 |
| LM252 | 169 |
| MC300 | 177 |
| MC305 | 176 |
| MC600 | 177 |
| MC605 | 176 |
| MC-C91-1000 | 101 |
| MC-C91-1500 | 101 |
| MC-C91-2000 | 101 |
| MC-C91-3000 | 101 |
| MC-CARB | 97 |
| MC-CB1-1000 | 101 |
| MC-CB1-1500 | 101 |
| MC-CB1-2000 | 101 |
| MC-CB1-3000 | 101 |
| MC-F1-1000 | 177 |
| MC-F1-1500 | 177 |
| MC-F1-2000 | 177 |
| MC-F1-3000 | 177 |
| MC-L1-45-1000 | 62 |
| MC-L1-45-1500 | 62 |
| MC-L1-45-2000 | 62 |
| MC-L1-45-3000 | 62 |
| MC-L1-50-1000 | 62 |
| MC-L1-50-1500 | 62 |
| MC-L1-50-2000 | 62 |
| MC-L1-50-3000 | 62 |
| MC-L1-60-1000 | 62 |
| MC-L1-60-1500 | 62 |
| MC-L1-60-2000 | 62 |
| MC-L1-60-3000 | 62 |
| MC-L2-45-1000 | 62 |
| MC-L2-45-1500 | 62 |
| MC-L2-45-2000 | 62 |
| MC-L2-45-3000 | 62 |
| MC-L2-50-1000 | 62 |
| MC-L2-50-1500 | 62 |
| MC-L2-50-2000 | 62 |
| MC-L2-50-3000 | 62 |
| MC-L2-60-1000 | 62 |
| MC-L2-60-1500 | 62 |
| MC-L2-60-2000 | 62 |

| | |
|---------------|----|
| MC-L2-60-3000 | 62 |
| MCL45 | 60 |
| MCL45P | 60 |
| MCL50 | 60 |
| MCL50P | 60 |
| MCL60 | 60 |
| MCL60P | 60 |
| MCL-SET | 61 |
| MC-NY1-1000 | 63 |
| MC-NY1-1500 | 63 |
| MC-NY1-2000 | 63 |
| MC-NY1-3000 | 63 |
| MC-W1-1000 | 89 |
| MC-W1-1500 | 89 |
| MC-W1-2000 | 89 |
| MC-W1-3000 | 89 |
| MC-W91-1000 | 89 |
| MC-W91-1500 | 89 |
| MC-W91-2000 | 89 |
| MC-W91-3000 | 89 |
| ML11 | 56 |
| ML11NI | 57 |
| ML12 | 56 |
| ML12NI | 57 |
| ML141 | 56 |
| ML141NI | 57 |
| ML142 | 56 |
| ML142NI | 57 |
| ML185 | 56 |
| ML185NI | 57 |
| ML186 | 56 |
| ML186NI | 57 |
| ML21 | 56 |
| ML21NI | 57 |
| ML22 | 56 |
| ML22NI | 57 |
| ML245 | 56 |
| ML245NI | 57 |
| ML25 | 56 |
| ML25NI | 57 |
| ML26 | 56 |
| ML26NI | 57 |
| ML285 | 56 |
| ML285NI | 57 |
| ML31 | 56 |
| ML31NI | 57 |
| ML32 | 56 |

| | |
|---------|-----|
| ML32NI | 57 |
| ML61 | 56 |
| ML61NI | 57 |
| ML62 | 56 |
| ML62NI | 57 |
| MLP45 | 56 |
| MLP45NI | 57 |
| MLP70 | 56 |
| MLP70NI | 57 |
| MOB41 | 144 |
| MOB42 | 144 |
| MOB44 | 145 |
| MOB45 | 145 |
| MOB62 | 146 |
| MOC24L | 145 |
| MOC24R | 145 |
| MOD52 | 144 |
| MOD82 | 146 |
| MOG35 | 146 |
| MOG36 | 146 |
| MOG40 | 146 |
| MOG47 | 144 |
| MOG50 | 144 |
| MOG55 | 145 |
| MOG86 | 147 |
| MOJ25L | 145 |
| MOJ25R | 145 |
| MOK128 | 147 |
| MOL25 | 145 |
| N168 | 71 |
| N170 | 71 |
| N268 | 71 |
| N270 | 71 |
| NB155 | 72 |
| NB158 | 72 |
| NB255 | 72 |
| NB258 | 72 |
| NC131 | 73 |
| NC132 | 73 |
| NC133 | 73 |
| NC141 | 73 |
| NC142 | 73 |
| NC142 | 73 |
| NC232 | 73 |
| NC233 | 73 |
| NC242 | 73 |
| NC243 | 73 |

| | |
|-------|----|
| NF130 | 70 |
| NF131 | 70 |
| NF132 | 71 |
| NF133 | 71 |
| NF134 | 72 |
| NF135 | 72 |
| NF140 | 70 |
| NF166 | 71 |
| NF167 | 71 |
| NF168 | 71 |
| NF169 | 71 |
| NF176 | 70 |
| NF230 | 70 |
| NF231 | 70 |
| NF232 | 71 |
| NF233 | 71 |
| NF234 | 72 |
| NF235 | 72 |
| NF240 | 70 |
| NF266 | 71 |
| NF267 | 71 |
| NF268 | 71 |
| NF269 | 71 |
| NF276 | 70 |
| NF332 | 71 |
| NF340 | 70 |
| NF376 | 70 |
| NG185 | 73 |
| NJ15 | 74 |
| NJ20 | 74 |
| NP177 | 71 |
| NP178 | 71 |
| NP179 | 70 |
| NP180 | 72 |
| NP181 | 72 |
| NP182 | 71 |
| NP190 | 72 |
| NP277 | 71 |
| NP278 | 71 |
| NP279 | 70 |
| NP280 | 72 |
| NP281 | 72 |
| NP282 | 71 |
| NP290 | 72 |
| NS136 | 72 |
| NS137 | 72 |
| NS169 | 73 |

| | |
|---------|-----|
| NS171 | 73 |
| NS172 | 72 |
| NS173 | 72 |
| NS186 | 73 |
| NS187 | 73 |
| NS192 | 72 |
| NS236 | 72 |
| NS237 | 72 |
| NS269 | 73 |
| NS271 | 73 |
| NS272 | 72 |
| NS286 | 73 |
| NS287 | 73 |
| NT315 | 73 |
| NT325 | 73 |
| NV5 | 70 |
| NV6 | 70 |
| NY38 | 74 |
| OL13 | 182 |
| OL15 | 182 |
| OV111 | 184 |
| OV112 | 184 |
| OV114 | 184 |
| OV131 | 184 |
| OV132 | 184 |
| OV133 | 184 |
| OV134 | 184 |
| P100 | 158 |
| P121 | 157 |
| P122 | 157 |
| P126 | 157 |
| P129ID | 132 |
| P131 | 156 |
| P132 | 156 |
| P136 | 156 |
| P151 | 158 |
| P152 | 158 |
| P159ID | 132 |
| P202 | 173 |
| P630 | 139 |
| P700 | 140 |
| P706 | 141 |
| PC611 | 171 |
| PC612 | 171 |
| PC616 | 49 |
| PC616W | 50 |
| PC616WP | 50 |

| | |
|--------------|-----|
| PCAR10-K-BLU | 94 |
| PCAR10-K-CN | 96 |
| PCAR10-K-G | 98 |
| PCAR10-K-NI | 98 |
| PCAR10-K-RED | 93 |
| PCAR10-K-SA | 98 |
| PCAR10-K-SPE | 100 |
| PCAR10-K-WHI | 95 |
| PCAR10-R-BLU | 94 |
| PCAR10-R-CN | 96 |
| PCAR10-R-G | 98 |
| PCAR10-R-NI | 98 |
| PCAR10-R-RED | 93 |
| PCAR10-R-SA | 98 |
| PCAR10-R-SPE | 100 |
| PCAR10-R-WHI | 95 |
| PCAR10-W-BLU | 94 |
| PCAR10-W-CN | 96 |
| PCAR10-W-G | 98 |
| PCAR10-W-NI | 98 |
| PCAR10-W-RED | 93 |
| PCAR10-W-SA | 98 |
| PCAR10-W-SPE | 100 |
| PCAR10-W-WHI | 95 |
| PCAR11-K-BLU | 94 |
| PCAR11-K-CN | 96 |
| PCAR11-K-G | 98 |
| PCAR11-K-NI | 98 |
| PCAR11-K-RED | 93 |
| PCAR11-K-SA | 98 |
| PCAR11-K-SPE | 100 |
| PCAR11-K-WHI | 95 |
| PCAR11-R-BLU | 94 |
| PCAR11-R-CN | 96 |
| PCAR11-R-G | 98 |
| PCAR11-R-NI | 98 |
| PCAR11-R-RED | 93 |
| PCAR11-R-SA | 98 |
| PCAR11-R-SPE | 100 |
| PCAR11-R-WHI | 95 |
| PCAR11-W-BLU | 94 |
| PCAR11-W-CN | 96 |
| PCAR11-W-G | 98 |
| PCAR11-W-NI | 98 |
| PCAR11-W-RED | 93 |
| PCAR11-W-SA | 98 |
| PCAR11-W-SPE | 100 |

| | |
|--------------|----|
| PCAR11-W-WHI | 95 |
| PL100 | 53 |
| PL100NI | 54 |
| PL100NI-F | 55 |
| PL101 | 53 |
| PL101NI | 54 |
| PL101NI-F | 55 |
| PL110 | 45 |
| PL110CN | 47 |
| PL110NI | 46 |
| PL111 | 45 |
| PL111CN | 47 |
| PL111NI | 46 |
| PL122L | 26 |
| PL122L-F | 28 |
| PL122NI | 26 |
| PL122NI-F | 28 |
| PL140 | 40 |
| PL140NIP | 42 |
| PL142 | 40 |
| PL142NIP | 42 |
| PL170K | 20 |
| PL170K-JR-RG | 22 |
| PL170K-LA-SA | 23 |
| PL170KRG | 22 |
| PL170KSA | 23 |
| PL170R | 20 |
| PL170R-JR-RG | 22 |
| PL170R-LA-SA | 23 |
| PL170RRG | 22 |
| PL170RSA | 23 |
| PL240K | 15 |
| PL240K-GO-CN | 16 |
| PL240K-JR-RG | 17 |
| PL240K-LA-NI | 17 |
| PL240R | 15 |
| PL240R-GO-CN | 16 |
| PL240R-JR-RG | 17 |
| PL240R-LA-NI | 17 |
| PL242K | 15 |
| PL242R | 15 |
| PL430 | 32 |
| PL430RG | 34 |
| PL440 | 36 |
| PL450 | 36 |
| PL500 | 9 |
| PL500NI | 10 |

| | |
|--------------|-----|
| PL510 | 9 |
| PL510NI | 10 |
| PL530 | 8 |
| PL530-GO-CN | 11 |
| PL530-GO-NI | 11 |
| PL530-JR-NI | 11 |
| PL530-JR-RG | 11 |
| PL530-LA-CN | 11 |
| PL530-TE-NI | 10 |
| PL540 | 8 |
| PL550 | 8 |
| PL550-GO-CN | 11 |
| PL550-GO-NI | 11 |
| PL550-JR-NI | 11 |
| PL550-JR-RG | 11 |
| PL550-LA-CN | 11 |
| PL550-TE-NI | 10 |
| PL560 | 8 |
| PL600 | 32 |
| PL600L-F | 36 |
| PL600NIP | 42 |
| PL600NIP-F | 42 |
| PL600RG | 34 |
| PL660 | 32 |
| PL660L-F | 36 |
| PL660NIP | 42 |
| PL660NIP-F | 42 |
| PL660RG | 34 |
| PL705 | 140 |
| PL707 | 141 |
| PLAT12-6-1M | 180 |
| PLAT12-6-2M | 180 |
| PLAT12-6-3M | 180 |
| PLAT14-6-1M | 180 |
| PLAT14-6-2M | 180 |
| PLAT14-6-3M | 180 |
| PLAT16-8-1M | 180 |
| PLAT16-8-2M | 180 |
| PLAT16-8-3M | 180 |
| PLAT20-15-1M | 180 |
| PLAT20-15-2M | 180 |
| PLAT20-15-3M | 180 |
| PLAT20-6-1M | 180 |
| PLAT20-6-2M | 180 |
| PLAT20-6-3M | 180 |
| POT10-RED | 102 |
| POT10-W | 103 |

| | |
|-----------|-----|
| POT11-RED | 102 |
| POT11-W | 103 |
| POT70-RED | 102 |
| POT70-W | 103 |
| POT71-RED | 102 |
| POT71-W | 103 |
| PR565 | 138 |
| PR711 | 168 |
| PR712 | 168 |
| PR716 | 168 |
| PR719FN | 129 |
| PR811 | 168 |
| PR812 | 168 |
| PR816 | 168 |
| PS121 | 156 |
| PS122 | 156 |
| PS126 | 156 |
| PS129ID | 132 |
| PW22 | 80 |
| PW25 | 80 |
| PW922 | 80 |
| PW925 | 80 |
| QZB106 | 153 |
| QZB116 | 153 |
| QZK14 | 153 |
| QZP135 | 153 |
| R1101 | 186 |
| R1102 | 186 |
| R14-1M | 181 |
| R14-2M | 181 |
| R14-3M | 181 |
| R16-1M | 181 |
| R16-2M | 181 |
| R16-3M | 181 |
| R18-1M | 181 |
| R18-2M | 181 |
| R18-3M | 181 |
| R2602 | 186 |
| R2603 | 186 |
| R2604 | 186 |
| R30-1M | 181 |
| R30-2M | 181 |
| R30-3M | 181 |
| RA40 | 176 |
| RA40CARB | 97 |
| RAC20 | 67 |
| RAL45 | 60 |

| | |
|--------|-----|
| RAL50 | 60 |
| RAL60 | 60 |
| RF100 | 197 |
| RF40 | 197 |
| RF50 | 197 |
| RF60 | 197 |
| RF70 | 197 |
| RF80 | 197 |
| RIV6 | 198 |
| RL7 | 56 |
| RL75 | 56 |
| RL75NI | 57 |
| RL7NI | 57 |
| RL9 | 56 |
| RL9NI | 57 |
| RO100 | 198 |
| RO60 | 115 |
| RO60 | 198 |
| RO65 | 198 |
| ROR120 | 198 |
| ROR63 | 198 |
| ROR95 | 198 |
| ROSE | 198 |
| ROT100 | 198 |
| ROT55 | 198 |
| ROT90 | 198 |
| ROT95 | 198 |
| S2701 | 187 |
| S2702 | 187 |
| S2703 | 187 |
| S2704 | 187 |
| S2801 | 186 |
| S2802 | 186 |
| S2803 | 186 |
| S2804 | 186 |
| S3301 | 187 |
| S3302 | 187 |
| S3303 | 187 |
| S3304 | 187 |
| S3501 | 186 |
| S3502 | 186 |
| S3503 | 186 |
| S3504 | 186 |
| S4102 | 187 |
| S4103 | 187 |
| S4104 | 187 |
| S4502 | 187 |

| | |
|----------|-----|
| S4503 | 187 |
| S4504 | 187 |
| S6002 | 187 |
| S6003 | 187 |
| S6004 | 187 |
| S6502 | 187 |
| S6503 | 187 |
| S6504 | 187 |
| SC100 | 195 |
| SC150 | 195 |
| SC30 | 195 |
| SC40 | 195 |
| SC50 | 195 |
| SC60 | 195 |
| SC80 | 195 |
| SE120-20 | 215 |
| SE120-24 | 215 |
| SE130-20 | 215 |
| SE130-24 | 215 |
| SE161-20 | 215 |
| SE174 | 217 |
| SE176 | 217 |
| SE182-30 | 218 |
| SE182-40 | 218 |
| SE184-30 | 218 |
| SE184-40 | 218 |
| SE186-30 | 218 |
| SE186-40 | 218 |
| SE202 | 219 |
| SE250G | 230 |
| SE250M | 226 |
| SE250P | 228 |
| SE293 | 219 |
| SE300 | 221 |
| SE310 | 221 |
| SE325-60 | 221 |
| SE325-80 | 221 |
| SE327 | 221 |
| SE345G | 230 |
| SE345G-6 | 230 |
| SE345M | 226 |
| SE345M-6 | 226 |
| SE345P | 228 |
| SE345P-6 | 228 |
| SE346G | 230 |
| SE346M | 226 |
| SE346P | 228 |

| | |
|-----------|-----|
| SE347G | 230 |
| SE347M | 226 |
| SE347P | 228 |
| SE564-100 | 217 |
| SE564-120 | 217 |
| SE564-140 | 217 |
| SE564-160 | 217 |
| SE87M | 213 |
| SE87PST | 213 |
| SE88-40 | 213 |
| SE88-50 | 213 |
| SE89-40 | 213 |
| SE89-50 | 213 |
| SE96 | 215 |
| SEB31 | 209 |
| SEB32 | 209 |
| SEB36 | 209 |
| SEB38 | 209 |
| SEB39 | 208 |
| SEB41 | 209 |
| SEB42 | 209 |
| SEB46 | 209 |
| SEB48 | 209 |
| SEB49 | 208 |
| SEB59 | 208 |
| SEC40 | 208 |
| SEC40S | 208 |
| SEC54 | 208 |
| SEC54S | 208 |
| SED10 | 209 |
| SED11L | 209 |
| SED11R | 209 |
| SED12L | 209 |
| SED12R | 209 |
| SED13 | 209 |
| SEG1 | 223 |
| SEG13 | 219 |
| SEG14 | 219 |
| SEG15 | 219 |
| SEG16 | 220 |
| SEG17 | 220 |
| SEG18 | 220 |
| SEG2 | 223 |
| SEG3 | 223 |
| SEG30 | 222 |
| SEG31 | 222 |
| SEG32 | 222 |

| | |
|----------|-----|
| SEG4 | 223 |
| SEG5 | 219 |
| SEG6 | 220 |
| SEG7 | 220 |
| SEG8 | 220 |
| SEG9 | 220 |
| SEK11 | 208 |
| SEK6 | 208 |
| SEP12 | 208 |
| SEP12P | 208 |
| SEP13L | 208 |
| SEP13LP | 208 |
| SEP13R | 208 |
| SEP13RP | 208 |
| SEP7 | 208 |
| SEP7P | 208 |
| SEP8 | 208 |
| SEP8P | 208 |
| SER30 | 209 |
| SER35 | 209 |
| SER37 | 209 |
| SER40 | 209 |
| SER43 | 219 |
| SER44 | 208 |
| SER45 | 209 |
| SER47 | 209 |
| SET40 | 224 |
| SEU30G | 222 |
| SEU30M | 222 |
| SEU30P | 222 |
| SEV50 | 212 |
| SH10 | 216 |
| SH11 | 216 |
| SH112 | 216 |
| SH12 | 214 |
| SH125-20 | 214 |
| SH13 | 216 |
| SH14 | 216 |
| SH142 | 212 |
| SH144 | 212 |
| SH155-20 | 214 |
| SH18 | 214 |
| SH20 | 217 |
| SH21 | 217 |
| SH22 | 214 |
| SH24 | 214 |
| SH242 | 212 |

| | |
|-----------|-----|
| SH243 | 212 |
| SH244 | 212 |
| SH245 | 212 |
| SH26 | 214 |
| SH28 | 214 |
| SH30 | 216 |
| SH31 | 216 |
| SH32 | 216 |
| SH33 | 216 |
| SH34 | 216 |
| SH35 | 216 |
| SH42 | 212 |
| SH43 | 212 |
| SH44 | 212 |
| SH45 | 212 |
| SH50 | 214 |
| SMC3 | 177 |
| SMC5 | 177 |
| SML31 | 61 |
| SML31CARB | 97 |
| SML32 | 61 |
| SP50 | 164 |
| SPL13 | 59 |
| SPL33 | 59 |
| SPL6 | 59 |
| SPL6P | 59 |
| SPM101 | 195 |
| SPM120 | 195 |
| SPM153 | 195 |
| SPM203 | 195 |
| SPM27 | 195 |
| SPM33 | 195 |
| SPM42 | 195 |
| SPM48 | 195 |
| SPM50 | 168 |
| SPM60 | 195 |
| SPM76 | 195 |
| SPM89 | 195 |
| SPP100 | 195 |
| SPP20 | 195 |
| SPP25 | 195 |
| SPP35 | 195 |
| SPP50 | 195 |
| SPP70 | 195 |
| SUP6 | 175 |
| SUP69 | 111 |
| SUP69ID | 133 |

| | |
|-------------|-----|
| SUP9 | 175 |
| SUP99ID | 133 |
| T201 | 179 |
| T202 | 179 |
| T206 | 179 |
| TB200 | 175 |
| TB200ZD | 175 |
| TB300 | 108 |
| TB300L | 65 |
| TB300NI | 65 |
| TB309 | 110 |
| TBL10 | 64 |
| TBL12 | 64 |
| TBL2 | 64 |
| TBL20 | 64 |
| TBL2CN | 47 |
| TBL2NI | 46 |
| TBL3 | 64 |
| TBL30 | 64 |
| TBL35 | 64 |
| TBL36 | 64 |
| TBL37 | 64 |
| TBL38 | 65 |
| TBL38RG | 22 |
| TBL40 | 64 |
| TBL5 | 65 |
| TBL53 | 65 |
| TBL53-GO | 65 |
| TBL53-GO-CN | 17 |
| TBL53-LA | 65 |
| TBL53LA-SA | 23 |
| TBL53-TE | 65 |
| TBL53-TE-NI | 10 |
| TBL54 | 65 |
| TBL56 | 65 |
| TBL57 | 65 |
| TBL6 | 64 |
| TBL60 | 65 |
| TBL6CN | 47 |
| TBL6NI | 46 |
| TBL7 | 64 |
| TBL70 | 65 |
| TBL70-BLU | 94 |
| TBL70-CN | 96 |
| TBL70G | 99 |
| TBL70NI | 99 |
| TBL70-RED | 93 |

| | |
|-----------|-----|
| TBL70SA | 99 |
| TBL70-SPE | 100 |
| TBL70-WHI | 95 |
| TBL7NI | 54 |
| TBL8 | 64 |
| TBL9 | 65 |
| TBL90-BLU | 94 |
| TBL90-CN | 96 |
| TBL90-RED | 93 |
| TBL90-SPE | 100 |
| TBL90-WHI | 95 |
| TCARB-BLU | 94 |
| TCARB-CN | 96 |
| TCARB-G | 99 |
| TCARB-NI | 99 |
| TCARB-RED | 93 |
| TCARB-SA | 99 |
| TCARB-SPE | 100 |
| TCARB-WHI | 95 |
| TF120 | 175 |
| TF125 | 175 |
| TF126 | 175 |
| TF129ID | 133 |
| TF130 | 175 |
| TF135 | 175 |
| TF136 | 175 |
| TF139ID | 133 |
| TF201 | 175 |
| TF205 | 175 |
| TF206 | 175 |
| TF529ID | 133 |
| TF539ID | 133 |
| TF59ID | 133 |
| TF629ID | 133 |
| TF639ID | 133 |
| TF69ID | 133 |
| TF70 | 175 |
| TF75 | 175 |
| TF76 | 175 |
| TF79ID | 133 |
| TM201 | 179 |
| TM202 | 179 |
| TM206 | 179 |
| TP54 | 175 |
| TP59ID | 133 |
| TP69ID | 133 |
| TP80 | 175 |

| | |
|------------|-----|
| TP85 | 175 |
| TP86 | 175 |
| TP89ID | 133 |
| TS209ID | 133 |
| TS4 | 175 |
| TS4CARB | 97 |
| TS5 | 175 |
| TS509ID | 133 |
| TS5CARB | 97 |
| TS6 | 175 |
| TS609ID | 133 |
| TS6CARB | 97 |
| TSL1 | 61 |
| TSL2 | 61 |
| TSL3 | 61 |
| TTC308-14 | 178 |
| TTC4010-20 | 178 |
| TTC408-16 | 178 |
| TTC408-18 | 178 |
| TTR144 | 179 |
| TTR166 | 179 |
| TTR182 | 179 |
| TTR183 | 179 |
| TTR184 | 179 |
| TTR185 | 179 |
| TTR186 | 179 |
| TTR187 | 179 |
| TTR216 | 179 |
| TTR308-14 | 178 |
| TTR308-16 | 178 |
| TTR4010-20 | 178 |
| TTR408-18 | 178 |
| TU12 | 189 |
| TU13 | 189 |
| TU14 | 189 |
| TU20 | 189 |
| TU30 | 189 |
| TU33 | 189 |
| TU40 | 189 |
| TU43 | 189 |
| TU44 | 189 |
| TU50 | 189 |
| TU60 | 189 |
| TUH12 | 189 |
| TUH13 | 189 |
| TUH14 | 189 |
| TUH20 | 189 |

| | |
|--------|-----|
| TUH30 | 189 |
| TUH33 | 189 |
| TUH40 | 189 |
| TUH43 | 189 |
| TUH44 | 189 |
| TUH50 | 189 |
| TZ59ID | 133 |
| TZ69ID | 133 |
| TZ72 | 175 |
| TZ75 | 175 |
| TZ76 | 175 |
| TZ79ID | 133 |
| VB640 | 210 |
| VB840 | 210 |
| VE6 | 210 |
| VE8 | 210 |
| VH108 | 180 |
| VL2 | 59 |
| VL3 | 59 |
| VM670 | 210 |
| VM870 | 210 |
| VR52 | 138 |
| VR53 | 138 |
| VSU50 | 180 |
| VSU70 | 180 |
| VZA1 | 174 |
| VZA2 | 174 |
| VZM1 | 174 |
| VZP200 | 174 |
| W100 | 81 |
| W110 | 81 |
| W168 | 86 |
| W170 | 86 |
| W268 | 86 |
| W270 | 86 |
| W50 | 81 |
| W60 | 81 |
| W75 | 81 |
| W80 | 81 |
| W9100 | 81 |
| W9110 | 81 |
| W9115 | 81 |
| W9140 | 81 |
| W9145 | 81 |
| W950 | 81 |
| W960 | 81 |
| W968 | 86 |

| | |
|--------|----|
| W970 | 86 |
| W975 | 81 |
| W980 | 81 |
| WB143 | 84 |
| WB144 | 84 |
| WB145 | 84 |
| WB146 | 84 |
| WB155 | 82 |
| WB160 | 84 |
| WB165 | 84 |
| WB180 | 84 |
| WB245 | 84 |
| WB246 | 84 |
| WB255 | 82 |
| WB260 | 84 |
| WB265 | 84 |
| WB280 | 84 |
| WB2900 | 85 |
| WB2900 | 87 |
| WB2910 | 85 |
| WB355 | 82 |
| WB810 | 85 |
| WB900 | 85 |
| WB900 | 87 |
| WB905 | 85 |
| WB910 | 85 |
| WB915 | 85 |
| WB943 | 84 |
| WB944 | 84 |
| WB945 | 84 |
| WB946 | 84 |
| WB955 | 82 |
| WB960 | 84 |
| WB965 | 84 |
| WB980 | 84 |
| WC100 | 86 |
| WC200 | 86 |
| WC64 | 86 |
| WC85 | 86 |
| WC9100 | 86 |
| WC964 | 86 |
| WC985 | 86 |
| WE14 | 84 |
| WE16 | 84 |
| WE18 | 84 |
| WE914 | 84 |
| WE916 | 84 |

| | |
|-------|----|
| WE918 | 84 |
| WF132 | 83 |
| WF133 | 83 |
| WF134 | 82 |
| WF140 | 82 |
| WF166 | 86 |
| WF232 | 83 |
| WF233 | 83 |
| WF234 | 82 |
| WF240 | 82 |
| WF266 | 86 |
| WF267 | 83 |
| WF268 | 83 |
| WF269 | 83 |
| WF332 | 83 |
| WF340 | 82 |
| WF932 | 83 |
| WF933 | 83 |
| WF934 | 82 |
| WF940 | 82 |
| WF966 | 86 |
| WF967 | 83 |
| WF968 | 83 |
| WF969 | 83 |
| WG274 | 87 |
| WG275 | 87 |
| WG294 | 87 |
| WG295 | 87 |
| WG973 | 87 |
| WG974 | 87 |
| WG975 | 87 |
| WG977 | 87 |
| WG993 | 87 |
| WG994 | 87 |
| WG995 | 87 |
| WG997 | 87 |
| WH111 | 88 |
| WH112 | 88 |
| WH121 | 88 |
| WH122 | 88 |
| WH211 | 88 |
| WH212 | 88 |
| WH221 | 88 |
| WH222 | 88 |
| WH311 | 88 |
| WH312 | 88 |
| WH321 | 88 |

| | |
|--------|----|
| WH322 | 88 |
| WH411 | 88 |
| WH412 | 88 |
| WH421 | 88 |
| WH422 | 88 |
| WJ10 | 86 |
| WJ20 | 86 |
| WK100 | 83 |
| WK120 | 83 |
| WK20 | 83 |
| WK25 | 83 |
| WK30 | 83 |
| WK40 | 83 |
| WK50 | 83 |
| WK60 | 83 |
| WK80 | 83 |
| WK9100 | 83 |
| WK9120 | 83 |
| WK920 | 83 |
| WK925 | 83 |
| WK930 | 83 |
| WK940 | 83 |
| WK950 | 83 |
| WK960 | 83 |
| WK980 | 83 |
| WM124 | 87 |
| WM34 | 87 |
| WM54 | 87 |
| WM9124 | 87 |
| WM934 | 87 |
| WM954 | 87 |
| WO5 | 85 |
| WO95 | 85 |
| WP178 | 83 |
| WP179 | 83 |
| WP181 | 81 |
| WP182 | 83 |
| WP190 | 81 |
| WP230 | 82 |
| WP231 | 82 |
| WP278 | 83 |
| WP279 | 83 |
| WP281 | 81 |
| WP282 | 83 |
| WP290 | 81 |
| WP930 | 82 |
| WP931 | 82 |

| | |
|-----------|-----|
| WP978 | 83 |
| WP979 | 83 |
| WP981 | 81 |
| WP982 | 83 |
| WP990 | 81 |
| WR10 | 84 |
| WR5 | 84 |
| WR6 | 84 |
| WR8 | 84 |
| WS169 | 85 |
| WS171 | 85 |
| WS172 | 85 |
| WS172FLAT | 85 |
| WS272 | 85 |
| WS969 | 85 |
| WS971 | 85 |
| WS972 | 85 |
| WS987 | 85 |
| WT14 | 86 |
| WT16 | 86 |
| WT18 | 86 |
| WT222 | 86 |
| WT422 | 86 |
| WT914 | 86 |
| WT916 | 86 |
| WT918 | 86 |
| WT922 | 86 |
| WU100 | 86 |
| WU65 | 86 |
| WU85 | 86 |
| WU9100 | 86 |
| WU964 | 86 |
| WU985 | 86 |
| WX5 | 85 |
| WX95 | 85 |
| XME3 | 211 |
| XNO3 | 211 |
| XP300 | 211 |
| XPA-B | 210 |
| XPA-F | 210 |
| XPA-R | 210 |
| XPA-V | 210 |
| XV1 | 211 |
| XV2 | 211 |
| Z1153 | 194 |
| Z1301 | 194 |
| Z1302 | 194 |

| | |
|-------|-----|
| Z1304 | 194 |
| Z1502 | 194 |
| Z2203 | 194 |
| Z2204 | 194 |
| Z2205 | 194 |
| Z701 | 194 |
| Z702 | 194 |

SCHUTT GRANDE FORGE SAS

1, RUE DES FUSILIERS MARINS - RD 468
67 114 ESCHAU - FRANCE

TÉL: (33) 03 88 64 09 98 - FAX: (33) 03 69 55 70 94
MAIL: INFO@GRANDE-FORGE.TM.FR
WWW.GRANDE-FORGE.COM